

Surveyor Manual

Scottish Household Survey – SHCS Physical Survey Element
Version 3.05

December 2018



Contents

1	Introduction.....	1
2	Overview of the survey method.....	3
Section A.	Contact information.....	12
Section B.	Contact information.....	16
Section C.	Base data.....	18
Section D.	Dwelling Description	32
Section E.	Characteristics of Common Block (Flats).....	50
Section F.	Characteristics of Common Block (Flats).....	65
Section G.	Room repairs	70
Section H.	Types of defect/condition	73
Section I.	Repairs to whole dwelling.....	82
Section J.	Rooms/Floor Summary	84
Section K.	Amenities	90
Section L.	Services and fittings.....	107
Section M.	Heating and Insulation	122
Section N.	Dwelling measurements for energy assessment.....	186
Section O.	Characteristics of common elements	204
Section P.	Repairs to common elements.....	213
Section Q.	External Construction/ Materials.....	220
Section R.	External repairs.....	257
Section S.	274
Section T.	Tolerable Standard and Statutory Action	275
Section 3	Definitions	295
Section 4	Housing Standards.....	300
Section 5	Potential action	303
Section 6	Surveyor Administration	306
Section 7	The Social Survey.....	324
Section 8	Health and Safety.....	326
Section 9	Guidance on Safe Gas/Oil Heating systems and appliances (M25).....	330

Appendix 1 Digital Pen instructions	338
Appendix 2 CADS website instructions	339
Appendix 3 Guidance on scoring a conservatory	340
Appendix 4 Guidance on scoring extensions.....	342
Appendix 5 Guidance note on storage heating	347
Appendix 6: Tips on dwelling drawings and measurements..	351
Appendix 7: Guidance on scoring stairs on the upper floor of four-in-a-block properties.	352

1 Introduction

1.1 Introduction

The SHS consists of two interlinked parts – a social and physical survey. **This manual covers the physical survey only** and is intended for use with the SHS physical survey form.

To carry out the survey successfully each surveyor needs to understand:

- the basic principles underlying the design and structure of the survey form;
- how to record information on the form;
- the methods of measurement used in the form;
- the overall standard of condition against which each dwelling is assessed;
- the definition of terms used in the form;
- the detailed content of each survey question and its application during physical inspection.

The manual is intended to provide a logical and comprehensive introduction to the technical aspects of these processes. It will be used extensively during the survey briefings and, once you are out in the field, will be your reference.

1.2 Structure and content of the survey form

The survey form has been designed to collect two types of information:

- facts about the dwelling – its characteristics and its surroundings – gathered through survey and observation; and
- information about the condition of the dwelling assessed using the professional judgement of surveyors, according to defined technical standards.

The SHS will be carried out across a wide variety of dwellings, using a large number of surveyors. The survey form has been designed to be used with all dwelling types in both the public and private sectors. The process of carrying out a survey has also been standardized so that, as far as possible, any two surveyors faced with the same dwelling will provide the same answer.

The survey form consists of 12 pages divided into 19 sections that are referenced alphabetically (See Section 2).

1.3 Version control

- Version 1.01 January 2012 - Manual updated to reflect changes from move from SHCS to physical survey part of the SHS. Section M updated based on info from Bill Sheldrick.
- Version 2.01 08 February 2012 – Section M updated. Changes made to reflect emails from Dave Cormack on 16th and 17th January.
- Version 2.02 08 Feb 2012 – Added Section N diagrams (from previous documentation)
- Version 2.03 Renamed latter sections as appendixes. Version printed for Feb 2012 training.
- Version 3.04 April 2018. Overhaul of manual before new surveyor training 23rd to 27th April.
- Version 3.05 December 2018. Updates to CAD section, Section D updated to include the reinstated question on parking provision and other minor edits throughout.

2 Overview of the survey method

Basic Principles

This section contains background information and basic principles for the Scottish Household Survey (SHS) physical survey.

2.1 Survey sample and coverage

The SHS consists of two interlinked parts – a social and a physical survey. **This manual primarily covers the physical survey.** For more details about the social interview, refer to **Part 7** of this manual.

The dwellings you will survey for the SHS have been selected at random. This is to help ensure that results are statistically valid and representative of dwellings across Scotland.

Over 6,000 addresses are issued to interviewers per year as part of the physical survey sample. All types of housing in Scotland are covered – flats and houses of all ages across the whole of urban, rural and island Scotland. It includes owned and privately rented housing as well as publicly rented homes.

The majority of addresses given to surveyors are ones where an Ipsos MORI interviewer has already carried out an interview with the occupier.

Only the named dwelling should ever be surveyed, because...

- ... we need to match the physical inspection data with the previous social interview;
- ... we need to ensure that the data is statistically representative.

This means that no other home can be used for the survey, even if it seems to have the same characteristics as the nominated dwelling, or if the occupant asks you to go there instead.

2.2 Structure and content of the survey form

The survey form has been designed to collect two types of information:

- facts about the dwelling – its characteristics and its surroundings – gathered through survey and observation; and
- information about the condition of the dwelling assessed using the professional judgement of surveyors, according to defined technical standards.

The SHS is carried out across a wide variety of dwellings, using a large number of surveyors. The survey form is designed to be used with all dwelling. The process of carrying out a survey has been standardized so that, as far as possible, two surveyors faced with the same dwelling will provide similar answers. Most questions need to be

completed for all dwellings though some questions only apply to certain types of dwelling e.g. flats. These are clearly indicated.

The survey form consists of 12 pages divided into 20 sections that are referenced alphabetically.

A	-	Contact Information	A1 – A5
B	-	Type of Survey	B1 – B2
C	-	Base Data	C1 – C5
D	-	Dwelling Description	D1 – D11
E	-	Characteristics of Common Block	E1 – E12
F	-	Room by Room Record	F1 – F2
G	-	Room Repairs	G1 – G8
H	-	Types of Defect/Condition	H1 – H13
I	-	Repairs to Whole Dwelling	I1 – I3
J	-	Rooms/Floors Summary	J1 – J5
K	-	Amenities	K1 – K26
L	-	Services and Fittings	L1 – L23
M	-	Heating and Insulation	M1 – M34
N	-	Dwelling Measurements	N1 – N7
O	-	Characteristics of Common Elements	O1 – O9
P	-	Repairs to Common Elements	P1 – P13
Q	-	External Construction/Materials	Q1 – Q50
R	-	External Repairs	R1 – R23
T	-	Tolerable Standard – Statutory Action	T1 – T15

2.3 How to code the survey form

The survey form should be completed with the digital pen. All answer codes and repair scores must be entered in the white boxes.

Please refer to the Appendix on how to use the digital pen.

LEADING ZEROES

Where a number is required, this should be entered from right to left and leading zeroes inserted to fill out the empty boxes.

UNOBTAINABLE AND NON-APPLICABLE INFORMATION

Where descriptions or assessments cannot be made against an individual element it is important to differentiate between the situation where the element is present but measurement has not been possible and the situation where no element exists. Standard conventions have been adopted for these situations:

Codes "9", "99", "999"	Element present but inspection not possible i.e. "unobtainable"
Codes "8", "88", "888"	Element not present i.e. "not applicable". (Code "8" is also used in the urgency column when an

element is not in disrepair ie. when repair score is "00". See Section 1.6).

You should use your professional judgement in circumstances where an element or arrangement is not immediately evident. Code "9" should only be used where it is not possible to form a reasonable assessment.

2.4 The survey sequence

The physical survey has 3 parts - internal, external and common parts. Sections F-N and part of Section T are concerned with the internal assessment; Sections D, Q, R, and parts of Section T are concerned with the external assessment; Sections E, O and P cover the common parts and common access if they exist.

On arrival ...

Complete the description of the surrounding area, dwelling and characteristics of the common block (if appropriate).

On gaining entry...

All rooms should be inspected, provided the householder is agreeable and the total number of rooms excluding the bathroom does not exceed six. If rooms need to be sampled then this should be done in a way that is representative of all floors and states of repair of the dwelling as a whole. Do not automatically select the best or worst rooms – the rooms selected must be representative.

Thank the householder before leaving, and refer them to the CADS Helpline on 0131 558 8999 if they have any queries.

Moving outside the dwelling....

In all cases complete the questions on external repairs, standards and action. In flatted accommodation, complete the assessment of any common areas and shared facilities.

Before departure...

You should take a minimum of one and a maximum of four external photographs. Normally two of these photographs will correspond to the two viewpoints selected in Section R. The remaining 2 photographs are of the area immediately surrounding the dwelling. Refer to question A5 for more information.

And finally...

Check the survey form for completeness and complete Section A.

2.5 Methodological principles

INTRODUCTION

As noted earlier, the form has been designed to collect information in a standard format. A number of basic principles underpin the approach that all surveyors must take.

The SHS physical survey methodology has drawn on the earliest local house condition surveys carried out in Scotland, as well as similar surveys carried out in other countries. Perhaps the most important point to make here is that *the cost of repairs to dwellings is calculated at the analysis stage, not estimated by the surveyor at the dwelling*. This means that the survey method may not always accord with surveyors' own perceptions or experience. However, the methodology is well established and fixed, and must be applied consistently by all surveyors. Only then will the results be credible to the analysts and politicians who rely on SHS data to formulate government policy.

HOW THE SHS PHYSICAL SURVEY HANDLES REPAIR COSTS

Surveyors are not asked to cost repairs to individual dwellings. The calculation of costs is done at the analysis stage, using a complex analytical model which assigns repair costs to elements.

The descriptive information about a dwelling, and the element by element assessments of disrepair, are fed into a computer program. This program, or cost model as it is usually called, takes the input data and produces a series of costs for each element of each dwelling. These are then summed up to produce a series of four key costs for each dwelling:-

- items requiring immediate repair;
- improvements for necessary items that are missing or below an agreed standard;
- action required to bring the dwelling up to the Tolerable Standard;
- repairs required to keep dwelling in good repair for the next 10 years.

In order to calculate costs in terms of dwelling types, a database of 174 stereotypes has been developed which defines dwellings that are typical of their age, type, shape and number of storeys. The descriptive information collected in the survey allows each dwelling to be assigned to one of these stereotypes on the basis of four key variables:-

- type of dwelling (including shape ie. detached, semi, terraced etc);
- age of dwelling;
- quality assessment of dwelling;
- number of storeys in the dwelling.

These core stereotypes are then further refined using information gathered about:-

- number of rooms;
- number of storeys in a common block;
- number of dwellings in a common block;

- presence/absence of a basement.

Once the dwelling is assigned to the stereotype, the renewal costs stored in the database for that stereotype - for 46 basic elements and a further 13 elements of the common facilities / access (if applicable) - are applied to the level of disrepair scored by the surveyor.

It can be seen, therefore, that the entire cost calculation system is based upon the surveyor recording descriptive information about the elements in a dwelling and their state of repair, and not attempting to prescribe or cost any remedial or improvement action to the premises.

ELEMENT DESCRIPTION

As shown above, the collection of basic dwelling and element descriptors is an integral part of the inspection process. Throughout the survey form, descriptive sections have been placed before repair sections in order to provide the context for repair assessment. This process of DESCRIPTION then ASSESSMENT is a fundamental part of the inspection sequence.

REPAIRS VERSUS IMPROVEMENTS

Disrepair is assessed only for elements that exist. **You must only score the existing element if it is in disrepair, not because you think it should be replaced by an improved specification to the item.** Improvements to the specification of an element because it is old, defunct or unavailable are not to be assessed.

The cost analysis program is able to distinguish between repair and improvement costs. Items and/or amenities that are missing and causing distress to the building fabric will therefore be picked up at the cost calculation stage of the analysis.

This is best understood via an example. In the SHS physical survey, if a surveyor records a missing DPC causing rising damp, the cost calculations will assign this an **improvement cost** (ie. to provide a DPC). In contrast, reported disrepair to an existing DPC causing rising damp will cause a **repair cost** to be assigned to the element.

In order to ensure correct cost allocation is therefore essential that you accurately, record the presence and absence of elements and their state of repair, but avoid judgments about upgrade or re-specification.

DISREPAIR AND LIFE

For the purposes of the SHS, surveyors must assume that all dwellings have an indefinite life and can be brought up to the desired standard. Surveyors must take no account of the economics of undertaking the necessary repairs. Specifically, **no anticipation of future repairs** with the intention of achieving economies of scale should be considered.

SCORE WHAT YOU SEE ON THE DAY

Surveyors must only score what they see on the day of survey. If a problem is intermittent (eg damp) and not visible on the day of the visit, then it should not be recorded.

VIEWING IN ISOLATION

The elements selected for survey are clearly defined and must be viewed in isolation from all others. Any linkage between elements will be handled by the cost model program. It is essential to view elements in isolation so that no double counting occurs during the analysis.

SELECTING A ROOM

A maximum of six habitable rooms, including the kitchen, are to be assessed for condition, together with the hall/landing, bathroom and separate WC. Where there are more than six general purpose rooms in the dwelling, you should select a representative sample for inspection. **Do not choose the best or worst rooms.** These should be chosen across all floors to represent the range of conditions present in the dwelling. See also the definition of a room in Section F.

SAFETY HAZARDS

The SHS physical survey has a Health and Safety Policy (see Part 8 of this manual) for your protection.

If you encounter conditions within the dwelling that represent an obvious danger to life and/or property, **do not discuss it with the occupier.** Make a separate record of the hazard and, **immediately after leaving the dwelling, contact your Regional Manager or the Physical Survey Project Manager and report the circumstances.** They will decide what action, if any, should be taken.

INVOLVING THE OCCUPIERS

You may ask the occupiers for information on the location of items (eg hot water tanks) and also seek information to confirm your initial opinion. However, you must always then confirm by inspection that an item exists and independently assess its state of repair.

In general, you should not rely on uncorroborated evidence about repair problems or defects /conditions given by the occupants. You are being asked to offer a professional judgment and should ensure that you personally inspect every required element.

There are a few specific items where it is acceptable to base your assessment on information from the occupiers. These are clearly specified in this manual and during the survey briefing. Under no circumstances should you use this approach for any questions other than those so specified.

If you have any questions about the survey principles or methodology, please ask your Regional Manager for advice.

2.6 Scoring disrepair and defects

Surveyors are required to identify the state of repair of both the internal and external features of the dwelling. Internal assessments are done on a room by room basis, whilst the external assessments take into account the common parts (if applicable) as well as the external elements of the dwelling selected for survey.

Once you have identified the element for assessment and determined its extent, you should go through the following steps:

- identify the presence of disrepair;
- determine the scale of that disrepair;
- determine the urgency of the repair (for external and common parts only);
- determine the residual element life after completion of necessary repairs (for external and common parts only).

1. IDENTIFY THE PRESENCE OF DISREPAIR

This is a matter for your professional judgement. All disrepair should be recorded, but note that maintenance problems should not be recorded as disrepair, e.g.

- gutters requiring to be cleaned out;
- removal of moss from roof finishes;
- replacement of glazing to a single window/door.

2. DETERMINE THE SCALE OF THAT DISREPAIR

Record the presence or absence of individual elements together with their levels of disrepair. Disrepair is measured on either a 5-point or a 10-point scale.

5-POINT SCALE OF DISREPAIR

In general the 5-point repair scale is applied to amenities and facilities internally and environmental repairs externally. The 5-point scale is as follows:-

Code 0:	No repair	0%
Code 1:	Small repairs	up to 5%
Code 2:	Minor repairs	5% to less than 25%
Code 3:	Medium repairs	25% to less than 60%
Code 4	Renew	60% to 100%

This scale applies to questions K6-10, K24-26, L15-18, M19-20.

10 POINT SCALE OF DISREPAIR

All other disrepair is measured using a 10-point scale. You record the quantity of the element that is in disrepair, as expressed in TENTHS of the total extent of the element. Disrepair can thus range from "00" (no defect) to "10" (complete renewal). You should also note that:-

- repairs to the external structure or elements of a dwelling or common block are assessed on 2 viewpoints and an average score applied at the analysis stage;
- repairs to common access ways and shared facilities and flats are assessed over the whole block;

- internal repairs elements are assessed room by room using the 10-point scale.

The 10 point scale is as follows:-

Code	Range	Mean
00	0%	-
55	<5%	-
01	5% <15%	10%
02	15% <25%	20%
03	25% <35%	30%
04	35% <45%	40%
05	45% <55%	50%
06	55% <65%	60%
07	65% <75%	70%
08	75% <85%	80%
09	85% <95%	90%
10	95% <100%	-

3. DETERMINE THE URGENCY OF THE REPAIR

With the external and common parts, the urgency of repair must be assessed for each element in disrepair (i.e. having a repair score of "55", "01" to "10").

If the timing of action varies between two viewpoints then the most urgent should be chosen. There are two categories of action:

- Code "1" repair action is urgent;
- Code "2" repair action is not urgent.

4. DETERMINE THE RESIDUAL ELEMENT LIFE AFTER COMPLETION OF NECESSARY REPAIRS

Where a repair defect is recorded the replacement period will reflect the life of the element after the repair is carried out. Where there is no repair required the replacement period should reflect the remaining life of that element.

The use of repair scores, internally and externally, varies for different types of repair situation. The application of the appropriate measurement base is therefore essential for the accurate calculation of repair scores and, subsequently, costs. The table below gives guidance on the usage of the percentage measurements throughout the form.

Questions	Section	Repair base
G1-G8	Repairs by Room	% of total element in each room e.g. wall finishes in the kitchen
I1-I3	Repairs to Whole Dwelling	% of total element occurrence whole house e.g. staircases on all floors

K6-K10, K24-K26	Amenities	% of total element e.g. WC, bath/shower
L15-L18	Services/Fittings	% of total element of installation e.g. whole house wiring or plumbing
M19-M20	Central Heating	% of total existing installation
P1-P13	Common Elements	% of common areas, whole block
R1-R23	External Repairs	% of or element present in whole block or dwelling viewpoint e.g. back with one side

DEFECTS AND TOLERABLE STANDARD

Defects and the Tolerable Standard scores represent the final measurement technique employed in the survey schedule.

In general the approach to assessment is through use of a nominal Yes/No scaling:

- | | | |
|-----|----------|--|
| Yes | Code "1" | the element is not defective or passes the standard; |
| No | Code "2" | the element is defective or fails the standard. |

Section A. Contact information

A1. Contact Record

Surveyors are to make at least 4 calls at the dwelling in order to gain access to both the interior, the exterior and common parts (if they exist).

At least one visit must be a weekday morning (Monday - Friday 9am -midday)

At least one visit must be a weekday afternoon (Monday - Friday midday to 6pm)

At least one visit must be a weekday evening (Monday - Friday 6pm to 9pm)

At least one visit must be a weekend (Saturday - Sunday 10am to 9pm)

Weekday calls should be on different days of the week in order to improve the likelihood of people being in. You must **not** call more than twice on the same day and ideally you should spread your calls over at least 2-weeks.

Where the web-site states that a dwelling description is required, you are required to make only one call to complete (see B1).

When there is no one in at the house, you should complete and leave a survey calling card. This reminds people that you have visited and makes it less likely that they will refuse to participate once you contact them in person. You may write your phone number on the card to enable householders to phone to make an appointment.

You should record your visits for this question as follows:-

Day	Monday	= 1
	Tuesday	= 2
	Wednesday	= 3
	Thursday	= 4
	Friday	= 5
	Saturday	= 6
	Sunday	= 7
Time	Morning (9am to noon)	= 1
	Early Afternoon (noon to 4pm)	= 2
	Late Afternoon (4pm to 6pm)	= 3
	Evening (6pm to 9pm)	= 4

Date You should record the date using the (dd/mm) format with a leading zero with necessary. A single number should be entered as “01”, “02” etc.

The “Surveyor’s Comments” boxes are to assist you in managing the order of calls to addresses. Items may include a description of the extent of survey completed at each call, such as “external survey only”, or information from the householder or a neighbour, like “requested Thursday afternoon”.

A2. Total number of calls

Enter the total number of visits made to the address in order that all relevant sections of the survey form were completed.

A3. Final outcome

This question records the outcome of the completed survey only, and not of each visit made.

Code 1: CONTACT

You have spoken to the dwelling's occupants and inspected all parts of the dwelling permitted by the householder. This may be any type of survey coded at B1.

Where the dwelling is a self-contained 'sheltered house/accommodation' you must contact the warden first who will often introduce you to the dwelling's occupant, preventing a possible refusal.

Code 2: NO CONTACT

After at least 4 visits to the dwelling, at the times and days specified at A1, you have been unable to contact any member of the household. You will have been unable to complete a full survey. If the dwelling was issued as a 'full survey' you will have only been able to complete a 'dwelling description'.

If the dwelling was issued as a 'dwelling description' or 'abbreviated dwelling description' then one visit to the dwelling address is required before this code is used, assuming no contact was made on the day of survey.

Code 3: CONTACT AND REFUSAL

You have spoken to a householder but they have refused to allow you to complete a survey of any type. You will only fill in A1 to A3, B1 (code 3), C1 to C5. You will not take any photographs of the property for this situation.

If the householder allows you to undertake some level of survey below a 'full survey' you can only undertake a 'dwelling description' then you must use Code 1 but add the reason for the downgrade of the survey in the surveyors comment box to appraise the survey office of the change.

Note: Where a householder allows you to undertake an internal survey but refuses access to one or more internal rooms you should not use this code. Instead you should record that you were unable to gain access using code 9: 'Unobtainable' against the relevant room at question F1: Room Level.

Code 4: OTHER (Please specify in notes)

A4. Recontact by another surveyor

A proportion of the surveys each surveyor completes will be reissued to their Regional Manager for checking and/or to another surveyor for re-survey.

This question asks you to assess whether it would be safe for another surveyor to call at the address. It is purely a Health and Safety issue and is **NOT** to be used simply because the occupier requests that no further calls be made. An example would be where you consider the address unsafe because of aggressive behaviour by the occupant.

Interviewers are asked a similar question when they conducted the social survey interview. Any dwellings considered as dangerous by the interviewer are not issued to surveyors.

You should **NOT** consider the safety of the neighbourhood for this question, only of the dwelling.

Code 1: YES

You consider that the occupants pose no threat to any other surveyor who may call. This code will be used for the vast majority of dwellings you visit.

Code 2: NO (EXCEPTIONAL CIRCUMSTANCES ONLY)

You have felt at physical risk by the occupants of the dwelling and do not wish anyone else to be put at risk.

You should not use this code where an occupant simply refuses to allow a survey to take place, or if he or she makes it clear they do not wish anyone else to call in connection with the SHS after you have completed a survey.

If you use this code, you must describe the reasons why in the surveyor notes section of the form.

A5. Photographic record

You must take the required number of photographs for each survey type. The following outlines the photographic requirements. If necessary return at a different time to take the photographs. The order of the photographs is not important.

The **only** circumstances where no photographs are required are where:

- the address has been withdrawn by Ipsos MORI;
- the dwelling is untraceable;
- the survey is an abbreviated dwelling description (ADD).

NOTE: Ensure that all photographs taken do not include the householder, or any other adult or members of their family

Abbreviated Dwelling Description**No photograph.**

The occupier has refused on site (see A3) or the address was issued as an ADD.

Dwelling Description Survey**One photograph required.**

(B1 code 2)

This is of the front of the dwelling, or if the dwelling is a flat, the front of the common block. (Refer to E2 for the definition of the common block).

Full Survey**Four photographs required, namely:**

(B1, code 1)

Two photographs of the dwelling, one to the front and one to the rear.

Two photographs of the area immediately surrounding the dwelling. For the majority of dwellings that form part of a street or cul-de-sac you should stand on the footpath outside the survey dwelling and take one photograph 'up the street' and one photograph 'down the street'.

In a rural setting you are still required to take two photographs in different directions even if the view is only of fields/mountains/sheep etc! Please do not take more than 4 photographs.

Normally you should not take more than one photograph of the dwelling from the same position. The only exception to this is where you are unable to access the rear of the dwelling, in which case take two photographs of the front.

Section B. Contact information

This section provides vital information as to the extent of the form completed. Both questions must be completed for all dwellings.

B1. Extent of survey completed

Code 1: FULL SURVEY

A full survey comprises an inspection of both the inside and the outside of the selected dwelling and an assessment of the neighbourhood.

All relevant sections should be completed, ie:

Houses (all types) Sections A, B, C, D, E1, F, G, H, I, J, K, L, M, N, O1, Q, R, T. (Do **not** complete Sections E2-12, O2-9, P).

Flats (own access) Sections A, B, C, D, E, F, G, H, I, J, K, L, M, N, O1, Q, R, T. (Do **not** complete Sections O2-8, P).

Flats (shared access) Sections A-T

In certain circumstances, you may be unable to gain access to all of the internal areas of a dwelling or to external points that afford views of the whole of the exterior. Some of the reasons this may occur are:-

- the occupant refuses access to particular rooms;
- some building elements cannot be seen (surveyors will be expected to exercise their professional judgement regarding these elements, using information gathered internally, etc);
- the rear of the building is inaccessible.

Codes "9", "99" or "999" (unobtainable) should only be used when an element is not visible and you cannot form an opinion from your professional judgement.

If you have been unable to complete some items on the form for the above reasons, but have been able to inspect both the inside and outside of the dwelling, the form should be coded as a full survey.

However, it is expected that the majority of questions will be answered in any section. You should always make every effort to gain access to the rear of buildings.

Code 2: DWELLING DESCRIPTION

Sections A,B,C,D & E

A dwelling description comprises a report on the external characteristics of the selected dwelling/common block containing the selected dwelling and a minimal assessment some neighbourhood characteristics.

Dwelling descriptions are normally issued as such to surveyors to properties identified as vacants or second/holiday homes.

Addresses issued as full surveys should only be submitted as dwelling descriptions where permission to proceed with the survey is refused or where you fail to make contact with a household after four visits.

When the occupant is out you should only complete a 'dwelling description' in the expectation of obtaining full access at a later visit. This data gathered can be submitted as an 'dwelling description' survey despite a subsequent doorstep refusal by the occupant (see A3).

Code 3: ABBREVIATED DWELLING DESCRIPTION

Sections A,B,C (page 1 only)

B2. Is Dwelling Occupied?

This is to identify dwellings that have fallen out of use but which still form part of the permanent housing stock. Dwellings that are in the process of exchange (ie. available for sale or rent at the time of the surveyor's visit) should be included as vacant.

Dwellings deliberately kept vacant during summer months in order that they are available to students during academic terms are to be considered as occupied.

Disrepair that would prevent the occupation of a dwelling could take the form of large areas of generally poor condition or small, localised areas of damage that compromise weather tightness.

Code 1: YES

Where you are unable to make contact with an occupant, the presence of furniture, curtains etc. within the dwelling can indicate occupancy.

Second or holiday homes are to be included under this code if normal signs of occupation are present.

Code 2: NO, SUITABLE FOR IMMEDIATE USE

(i) You have been unable to contact an occupant and the dwelling shows no signs of occupation, furniture, furnishings etc.

(ii) The dwelling exterior (and interior if visible) shows no serious disrepair of a type or level that would prevent the dwelling being immediately occupied and there is no requirement for other substantial investment in respect of remedial or improvement works.

Code 3: NO, REQUIRES REPAIR

(i) You have been unable to contact an occupant and the dwelling shows no signs of occupation, furniture, furnishings etc.

(ii) The exterior of the dwelling (and interior if visible) shows signs of disrepair of a type or level that would prevent the dwelling being immediately occupied and/or there is a requirement for other substantial investment.

Section C. Base data

This section records key facts about the nature of the dwelling.

Surveyors are reminded that the survey is only concerned with dwellings that form part of the **permanent** housing stock.

All dwelling types are classified as either **HOUSES** or **FLATS**:

HOUSES	<ul style="list-style-type: none"> - are divided vertically from other dwellings, commercial premises etc - do not have separate dwellings, commercial premises etc. above or below them either in whole or in part; - usually have their principal access from ground level; - possess their own roof; repairs are not shared with another dwelling(s).
NOTE	<p>Dwellings that have been formed as the result of a conversion and which meet the above definition of a house, are to be recorded using Codes 1-5. There is no CONVERSION answer category for houses.</p>
FLATS	<ul style="list-style-type: none"> - are dwellings that are, either wholly or in part, divided horizontally from other dwellings, commercial premises etc; - are usually one floor but can be two or more in the case of maisonettes.

C1. Type of house

SEE DIAGRAM C1 - PLAN TYPES

NOTE Codes 1 and 3 to 7 apply to single level and multi-level houses. Code 2 can only be used with houses of two or more storeys.

Code 1: MID TERRACE

A house situated in the middle of a row of three or more dwellings, commercial premises etc. The dwelling being surveyed will therefore have two party walls.

Agricultural outbuildings attached to a detached farm/crofter's cottage etc. do not form part of a terrace within this definition. See Code 5 detached houses.

Code 2: TERRACE WITH PASSAGE

This category is to be used for houses in a mid-terrace, end terrace or semi-detached situation, which have an external wall that forms part of a ground level passageway. The arrangement of the rooms above the passageway is not important

The purpose of this category is to identify those terraced houses that will record a greater heat loss through their external walls due to the presence of the passageway.

This code should not be used for single story dwellings (unless there is habitable rooms in the roof space).

Repairs associated with the passageway should be recorded in Section Q (External Construction/Materials).

Code 3: END TERRACE

A house situated at the end of a row of three or more dwellings, commercial premises etc.

Code 4: SEMI-DETACHED

These two dwellings, when taken together as a single unit, should be physically separate from other dwellings excepting:

- tenuous physical connections, such as the cross attached junctions; see **DIAGRAM C1**.
- single storey non-habitable link blocks, such as stores and garages, which abut adjoining dwellings.
- agricultural outbuildings attached to a semi-detached farm house/crofter's cottage.
- the above arrangements do not prevent a dwelling being classified as semi-detached.

Code 5: DETACHED

A house that is free standing with no party walls. You should ideally be able to walk or see around the entire dwelling. Where this is not possible and houses almost connect there should be evidence of either:

- an air space; or of
- completely independent structures.

The following arrangements do not prevent a dwelling being classified as detached:

- single storey non-habitable link blocks, such as stores and garages, which abut adjoining dwellings;
- agricultural outbuildings attached to a detached farm house/crofter's cottage on one or both sides.

Code 6: CORNER/ENCLOSED END

As mid-terrace (Code 1) but at a junction or turn and physically linked to dwellings or commercial premises on either side.

Enclosed end code also used to describe a back to back end terrace house. Dual aspect dwelling similar to a corner house.

Code 7: ENCLOSED MID

Enclosed Mid code used to describe a back to back mid terrace house. There is only a single exposed wall to the dwelling and three shared walls

Code 8: NOT A HOUSE

The dwelling being surveyed is a flat.

Diagram C1

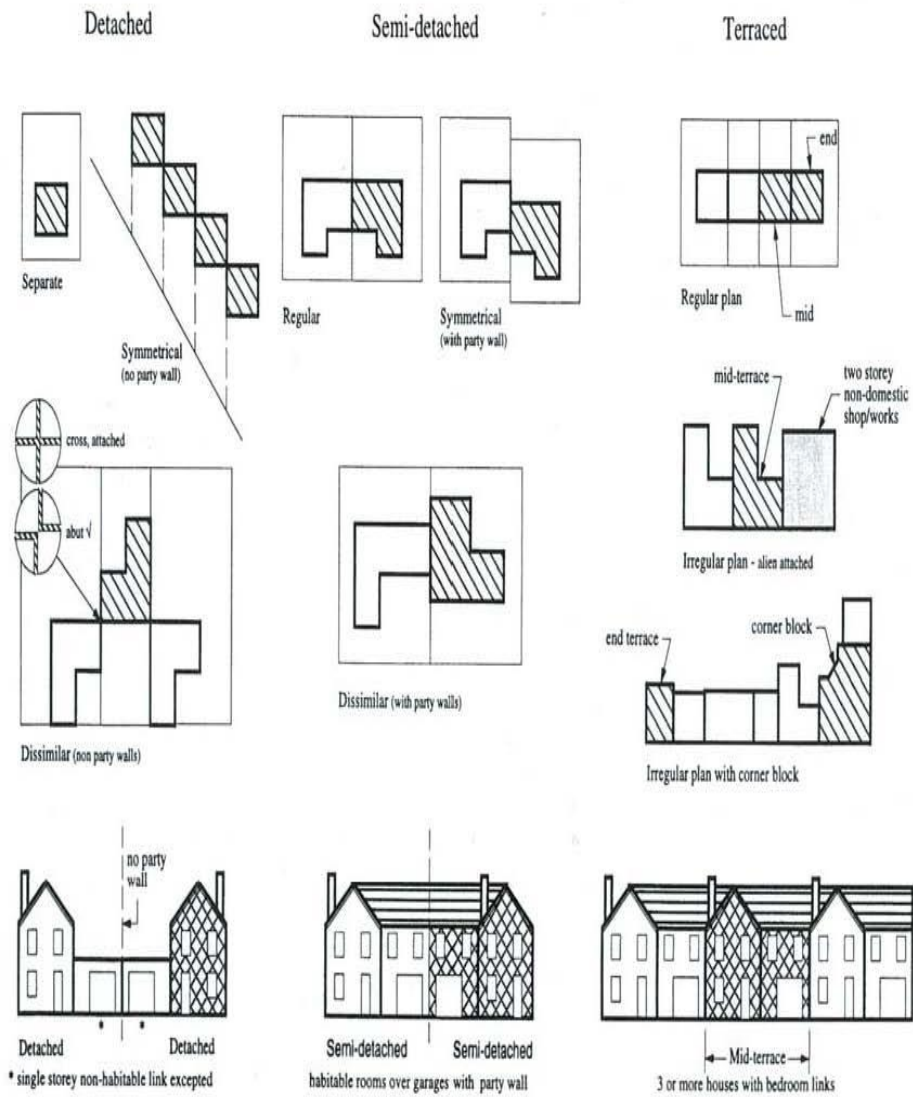

C2. Type of flat**Code 1: TENEMENT**

A tenement flat is a dwelling within a common block of two or more floors (commonly up to five storeys but may be higher in certain circumstances) where some or all of the flats have a shared or common access. It is not necessary for the selected dwelling to be within the shared or common access, but the shared or common access must be present within the **common block** containing the selected dwelling.

Examples of this situation are the ground floor flats to tenement blocks which have their own main door directly to the street. The flats on the upper levels are accessed by means of a common stair and therefore all flats within the block, including the ground floor (own access) flats are tenement flats.

This definition is very broad and will consequently encompass a large number of flats that you might not otherwise consider to be tenement flats.

NOTE: To illustrate this point consider a block of four flats with two at ground level and two at first floor level.

If all of the flats within the block have their own independent access all flats within the block are 4-in-a-block type flats (see Code 2, 4-in-a-block type).

If the two upper flats have their own independent access stair and the two ground floor flats are accessed off a common passage at ground level then this is a tenement with ground only access.

If two or more flats are accessed by a common access stair and landing with or without a common passage then this is a tenement with stair and landing access.

This same principle applies to flats located above commercial premises.

Code 2: 4-IN-A-BLOCK TYPE

If each flat within the **common block** containing the selected dwelling has its own separate access then all flats within that block are classified as 4-in-a-block type flats.

This definition is very broad, extending beyond the dwelling type generally recognised as 4-in-a-block, and will consequently encompass a large number of flats that you might not otherwise consider to be 4-in-a-block type flats.

For example, 4-in-a-block type flats do not have to exist in groups of four, and conversely not all blocks of four flats are 4-in-a-block type flats (see note Code 1).

Code 3: TOWER/SLAB

The dwelling is a flat or maisonette in a tower or slab block:

Towers	- are ten or more storeys high; - will usually contain at least one lift; - usually have at least four dwellings per level.
Slabs	- are generally over five storeys high; - can be either “walk-up” or multi-storey; - have predominantly horizontal circulation.
Passage/corridor	- 6 or more dwellings accessed from a corridor or internal passage.
Deck	- habitable rooms located above or below walk ways
Gallery	- walk ways located within main structure (under roof to block) and may be open to external air.
Balcony	- walk way projects beyond the main structure (outwith roof line to block). - Often have vertical circulation at more than one location within the block; and are commonly a post-war frame type construction.

Code 4: FLAT FROM CONVERTED HOUSE

A flat or maisonette in a converted house: This covers all cases where a house has been converted to provide more than one unit of accommodation/other premises. Flats in a block converted from commercial properties are treated as custom flats and are assigned to codes 1 to 3 above.

Code 8: NOT A FLAT

The dwelling being surveyed is a house.

C3. Quality assessment of dwelling

SEE QUALITY TYPES DIAGRAM.

This question is designed to identify those dwellings that will incur higher levels of repair costs due to any or all of the following:-

- their scale;
- the materials and finishes used;
- the quality of detailing.

It would be wrong to compare the quality of a pre-1919 stone built detached house with a post 1982 timber framed detached house. Surveyors should *only* consider the dwelling in respect to its peers. In other words:

What is the quality of this pre-1919 stone built detached house compared to all other pre-1919 stone built detached houses?

This assessment should be based upon the relative standard of the dwelling as originally built.

Subsequent improvements are not to be considered.

The actual condition of the dwelling is not to be considered.

There is no separate category for “below average quality dwellings”.

Code 1: BASIC

Basic dwellings will generally exhibit the following characteristics:

- utilitarian design;
- minimum space standards;
- originally designed to sell at the bottom end of the market.

Most public sector housing will be of a basic quality.

Code 2: BETTER THAN BASIC

- space above minimum standards
- some modelling to facade, bay windows etc.

Code 3: OF SUPERIOR QUALITY

- large rooms with high ceilings
- elaborate detailing such as oriels, and complex chimney heads.
- heavy modelling to facade, porches, turrets, two-storey bay windows, rative dormers, complex roofs etc.
- originally designed to sell at the top end of the market.

**SUPERIOR
QUALITY**

Pre 1919 Tenement

Ornate stonework around windows and doors and at wall head.

Sculpture at wall head(far left).

Complex and unusual roof forms.



**BETTER THAN
BASIC**

Pre 1919 Tenement

Bay windows with associated roof form.

Some modelling of stonework around windows, doors and chimneys.



BASIC

Pre 1919 Tenement

Block consists of a simple box shape with little or no architectural enhancement.



**SUPERIOR
QUALITY**

***Pre 1919 Detached
House***

Ornate stone columns
at bay windows and
door.

Richly carved
stonework around
central window,
across projecting
bays, along eaves
and at corners.



**BETTER THAN
BASIC**

***Pre 1919 Detached
House***

Some detailing of
stonework around
main door and at
eaves level.

Bay windows.

Stone balustrade
above main door.



BASIC

***Pre 1919 Detached
House***

House consists of a
simple box shape
with little or no
architectural
enhancement.



**SUPERIOR
QUALITY**

***Pre 1919 Detached
House***

Detailed stonework
around windows and
at door.

Projecting stone bay
window.

Shaped coping.

Shaped roof slates.



**BETTER THAN
BASIC**

***Pre 1919 Detached
House***

Turret feature for
main door.

Bay window.

Crow stepped gables
with stone thistle
motif.



BASIC

***Pre 1919 Small
Detached House***

House consists of a
simple box shape
with little or no
architectural
enhancement.



C4. Estimated year of construction

Surveyors are asked to estimate the actual year of construction of the dwelling, not the probable date of warrant submission as in the NHER age banding later in the form. You should provide the year in 4 digits.

The year of construction is taken as the oldest part of the original structure even if it is the smallest part of the dwelling. Where a dwelling has been created as a result of a conversion, you should record the date appropriate to the original structure.

You should be aware that the original construction may have been considerably altered or modified since built, such as re-roofing with tiles rather than slates and the addition of external wall insulation.

Identifying the Year of Construction

Sometimes you will be lucky enough to find date stones on the dwelling or a neighbouring dwelling of identical construction type to the survey dwelling. Some modern estates have a date stone at the entrance to the development.

Occupiers often know the date of construction and surveyors are being encouraged to ask the current occupier if they know the actual year the dwelling was built. This may not be appropriate in some circumstances and surveyors are asked to use their judgement on when and how to ask.

In the absence of a definite indication of when the dwelling was constructed, you are required to use your experience and judgement. The following should be considered in determining the date of construction:

- Architectural style;
- Building materials;
- Plot size & general setting;
- Estate layout;
- Neighbouring dwellings;
- Ceiling heights.

Be aware that upgrading of roof coverings, windows (style and materials) and doors (again, both style and materials) is not uncommon. These items should only be considered to confirm that they are consistent with the judgement based on architectural style etc. In particular, you should look for any materials that indicate an earlier date of construction.

Comparison between the survey dwelling and its neighbours is often very useful. If the dwelling is on an estate it is likely that they were constructed at the same time, and some properties will remain unchanged. On local authority estates assessment is more difficult since the majority of dwellings may have been upgraded at the same time under capital programmes. However some 'right to buy' dwellings may be unimproved so clues may exist in the surrounding area.

C5. Date of construction of dwelling (banded)

The age bands reflect different architectural styles, construction techniques and building regulation standards. These are related to the year of construction and continue to be collected in the form previously defined. This band should tie in with the year of construction at C4 above.

Code 1: Pre 1919

Dwellings in this age band are assumed to have solid wall construction, either stone or brick. Solid brick walls can be distinguished from brick cavity walls as there are header bricks appearing in a repetitive pattern in the main wall construction.

Windows were originally traditional single glazed wooden sash windows.

Ceiling heights in rooms on lower storey often in excess of 3m with cornices, some ceiling roses and moulded skirting boards.

Code 2: 1919 – 1944

This age band will include both solid brick constructions up until 1930 with cavity construction introduced after this date. Render wall finishes predominate with facing brick limited to architectural features.

Early forms of concrete block were introduced during this period.

Steel window frames were introduced in the 1930's.

Many local authority 4-in-a-block type flats were built during this period with large room sizes and generous storage.

Code 3: 1945 - 1964

The period after the second world war is when the majority of local authority dwellings re constructed including non-traditional forms of construction and high-rise flats.

Dwellings were usually of cavity construction. (Brick cavity walls can be distinguished from solid brick walls as there are no header bricks in the main wall construction.) Concrete blocks introduced into dwelling construction. Rendered wall finishes predominate.

There are few architectural enhancements and room sizes were reduced for reasons of cost and shortage of materials.

Casement windows became more common.

Driveways and garages start to be built in the 1960s.

Some flat roofed dwellings were built around the early 60s

Code 4: 1965 - 1982

Houses are relatively large with private front and rear gardens. Front gardens will be fenced. There is likely to be mature trees and hedges. Dwellings on estates are likely to have only one or two dwelling types. Most roads will be 'access roads' to other parts of the estate and there

will be few cul-de-sacs. The layout of new towns were pedestrian friendly separating cars from people. Traffic calming measures will not have been included with the estate when it was originally built.

Dwellings are predominantly masonry cavity construction using block/brick or brick/brick. Some solid timber frame was built in the early 70s without cavity ventilation with a wall thickness less than 150mm. Rendered wall finishes predominate.

Chimneys were built until the end of the 60s when central heating replaced coal fires.

Building regulations required some loft insulation starting at 25mm in 1965 and increasing to at least 50mm in 1975. Post 1978 it became quite common to install 75-80 mm of loft insulation. However many dwellings will have been upgraded by their owners. The original layer may still be present.

Code 5: 1983 - 2002

These dwellings are generally located on modern estates comprising cul-de-sacs with traffic calming measures such as rumble strips and road narrowing. Roads may be mono-block. Estates are typified by small front and rear gardens. There is often no fencing to front gardens. There is likely to be a mix of house types and flats on these estates.

The majority of these dwellings are timber frame some of which will have open perpendos or cavity ventilators. Rooms and windows are small. Facing brick and self coloured render predominates. There are likely to be architectural enhancements such as bay windows and small-hipped roofs especially in the newer dwellings. Virtually all windows will be double glazed. Timber window frames are common.



















There will be a minimum of 100mm loft insulation, the value increasing as the dwellings get newer to 250mm. Mechanical extract unit in both the bathroom and kitchen should be present in all post 1991 dwellings.



Code 6: Post 2002

There will be a minimum of 250 mm loft insulation, the value increasing as the dwellings get newer to 300 mm. Mechanical extract unit in both the bathroom and kitchen should be present.

All windows will be double or triple glazed. Window openings are small and timber window frames will be common.

Dwelling Type by Date of Construction

	Pre 1919	1919-1944	1945-1964
Detached			
Semi-Detached			
Terrace			
Tenement			
4-in-block type			
Tower/slab			
Flat in converted building			
	Pre 1919	1919-1944	1945-1964

	1965-1982	1983-2002	Post 2002
Detached			
Semi-Detached			
Terrace			
Tenement			
4-in-block type			
Tower/slab			
Flat in converted building			
	1965-1982	1983-2002	Post 2002

Section D. Dwelling Description

This section covers key facts about the nature of the dwelling.

D1. Entry level of dwelling

SEE DIAGRAM D1

You should record the entry level to the dwelling itself i.e. the main front door to a path, road, close, corridor or external stair or access balcony.

Data on the level of rooms relative to the entry level (above or below) is collected at F1 and is not to be considered by this question.

A 4-in-a-block type (own door) flat with all rooms at first floor level is entered

- directly at ground level (own internal stair) - Code 0;
- at first floor level via an external stair - Code 1;
- at a mid-level via an external stair - Code 1.

External entrances situated half way between floor levels, or above the half way point, should be rounded up to Code 1. External entrances situated below the half way point between floor levels should be rounded down to Code 0.

Where the entry to a dwelling is at a level that is classified as basement, using the definition at J4, then the entry level should be recorded as Code 7 "Basement". In sloping site situations, this rule remains valid even when the dwelling is entered at the lower ground level - see Diagram J4.

Diagram D1

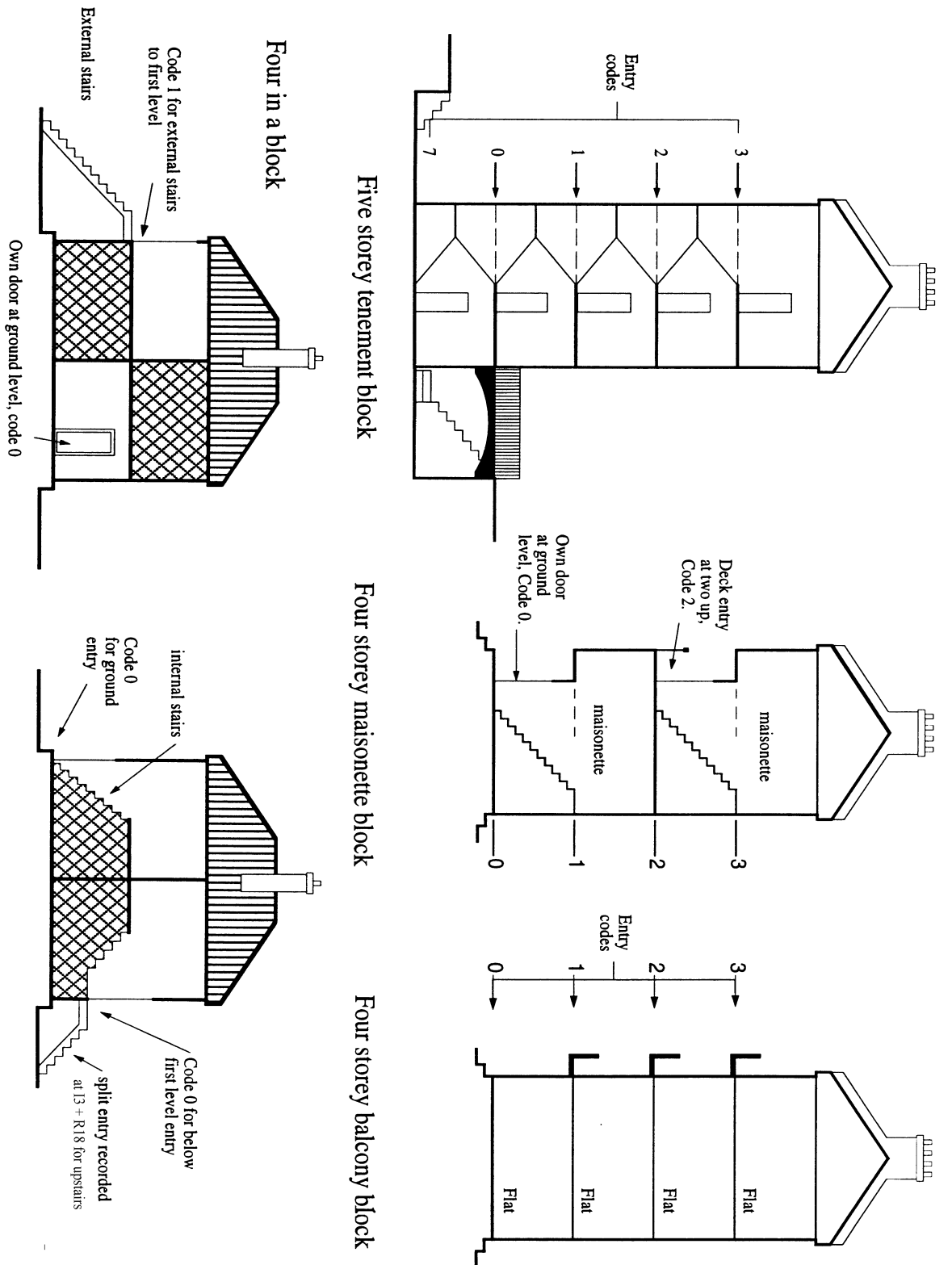

D2. Wheelchair access to entrance door of dwelling or common block is...

This question assesses the suitability for wheelchair users of the **current** gate/boundary gap and surface access within the dwelling's curtilage between the public footpath/ road and the dwelling or common block.

The entrance door need not be the front door to the dwelling/block. Where there is a choice of more than one entrance door the entrance involving the least number of steps should be chosen.

You should not assess the potential for step free access here as it is covered later in question D4.

For the purposes of this question, the entrance door is taken to be:

The door that separates the interior of the dwelling from the external environment;

The door that separates the common circulation space (in blocks of flats with shared access) from the external environment. In shared access situations where no door exists you should assess the access to the threshold of the block. The presence of a door is not recorded here.

For this question you should assess:

Gates and Entrance. These are required to have a clear opening **width of 850mm**. Examples of entrances include brick arches and the gap in a boundary wall or hedge providing access to the dwellings curtilage through which a wheelchair would require to pass to reach the dwelling;

Gates and entrances are not always located on the boundary line. Side gates should also be assessed if they are on the route a wheelchair would require to use to reach the entrance you have selected;

Surface Access Material. The surface on which a wheelchair would require to use requires to be a minimum **900mm wide and of a hard standing material**.

Examples of suitable hard standing surfaces include; Mono-block, Slabs, Concrete, Asphalt and Crazy paving

Example of unsuitable surfaces include; Stone chips, Gravel and Earth/grass

The state of repair of the surface access material should not be considered here. Disrepair is assessed in question R20.

Where the pedestrian access is unsuitable, you should also consider alternative routes such as the driveway.

Code 1: INADEQUATE WIDTH, HARD STANDING

There is no suitable wheelchair access to the dwelling or common block.

The width of the gates / boundary gap is less than 850mm wide and/or the width of the surface access is less than 900mm.

The surface access material is of hard standing.

Code 2: SUITABLE WIDTH, HARD STANDING

There is suitable wheelchair access to the dwelling or common block.

The width of the gates / boundary gap is greater than 850mm and the width of the surface access is equal or greater than 900mm.

The surface access material is of hard standing.

Code 3: LOOSE/ UNSUITABLE SURFACE

The surface access material is unsuitable for wheelchair access.

The width of any gates / boundary gaps are not relevant to this category.

Code 8: NOT APPLICABLE

The dwelling or common block is entered directly from the footpath or road.

Where the access to the dwelling or the common block is directly off the public footway (i.e. there is no pathway between the public footway and the entrance to the dwelling or block)

Code 9: UNOBTAINABLE

You are unable to assess the suitability of the wheelchair access to the entrance door of the dwelling or common block.

D3. Pathways from road and/or car spaces up to but not including the entrance door to the dwelling or common block are...

This question is designed to collect information on the current, or potential, provision of access to a barrier free entrance door or, if no such door exists, to the entrance door involving the least number of steps.

You must assess the same entrance door for both D2 and D4.

For the purposes of this question, the entrance door is taken to be:

- the door that separates the interior of the dwelling from the external environment;
- the door that separates the common circulation space (in blocks of flats with shared access) from the external environment. In shared access situations where no door exists you should assess the access to the threshold of the block. The presence of a door is not recorded here.
- when considering whether a dwelling or common block is potentially step-free consider all entrances to the dwelling and select the entrance with the fewest steps.

The entrance door need not be the front door to the dwelling/block.

The door width is not assessed at this question but is considered at D2 (entrance door to dwelling) and/or (entrance door to common circulation).

Ramps suitable for Barrier Free access must:

- be a minimum of 1 metre wide;
- have a maximum gradient of 1:12 (the maximum to allow unassisted wheelchair access);
- have a level platform at least 1 metre deep outside entrance doors;
- have intermediate platforms if over 10 metres long with a gradient of 1:15 or steeper;
- Do not consider the aesthetics of any alterations that are necessary. Simply consider if there is enough space for the required ramp.

You should use the following table will help you to assess the potential for replacing steps (taken to be approx 175mm high) with a ramp.

No. of steps at 175mm each	Ramp equivalent	Ramp equivalent and platform at door
1	2.1m	3.1m
2	4.2m	5.2m
3	6.3m	7.3m
4	8.4m	9.4m
5	11.5m	12.5m

Where steps are noticeably shallower than 175mm you should use the ramp length equivalent for one step less than actually present.

Code 1: STEP FREE NOT POSSIBLE

Provision of a ramp is either not possible or is considered impractical.

The following examples would be considered to make the provision of a ramp impractical:

- more than 5 steps in any one flight;
- less than 1 metre between the entrance door and the curtilage of the dwelling/block.

Code 2: POTENTIALLY STEP FREE

A ramp, or ramps, could be added (either replacing or augmenting the steps) to provide step free access to the entrance door from the road, from a “dropping-off” point or from a car space.

Where a flat is entered via an access that is in common ownership it is to be taken that it will not be possible to overcome any existing changes in level that prevent it currently being considered Barrier Free. Therefore "potentially step free" **cannot** be recorded against dwellings entered via a common access.

The roadside kerb is **not** to be considered as part of this assessment.

Code 3: STEP FREE

There are no stepped changes in level greater than 20mm and the maximum gradient is 1:12 between the entrance door and the road, a “dropping-off” point or a car space.

The roadside kerb is not to be considered as part of this assessment.

Code 8: NOT APPLICABLE

The dwelling or common block is entered directly from the footpath or road.

Code 9: UNOBTAINABLE

Unobtainable should only be recorded where:

- you cannot gain access to any entrance door, or;
- you cannot gain access to a rear door and the main entrance door has been assessed as step free not possible.

D4. Number of access steps within the curtilage to the entrance door

SEE DIAGRAM D4

The steps to be counted here are the steps between the boundary of the property and the entry to the dwelling or the common block. Where the dwelling is within a common block, do not count steps between the entry to the common block and the dwelling itself at this question.

Include all steps, both up and down, from the edge of the curtilage of the site to the entrance level recorded at D1 including the threshold at the entrance door.

Where there is no defined curtilage (such as an open plan front or a footpath estate) you should make an assumption using boundaries such as the back line of a public footway.

Diagram D4

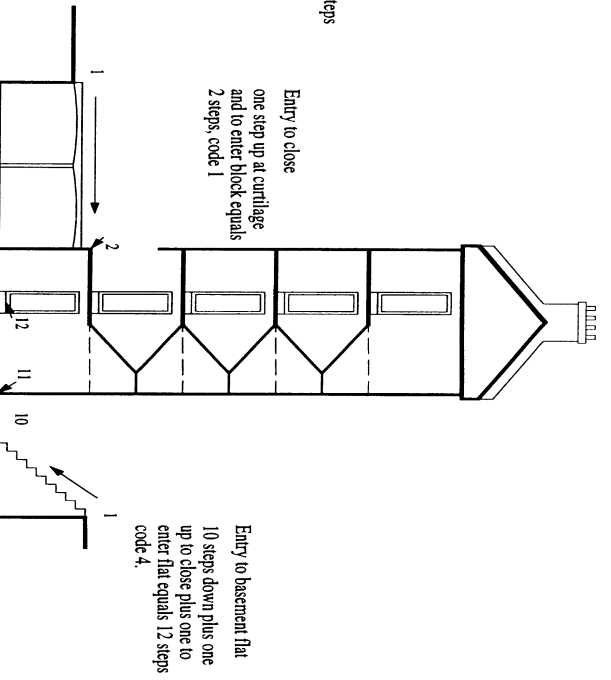
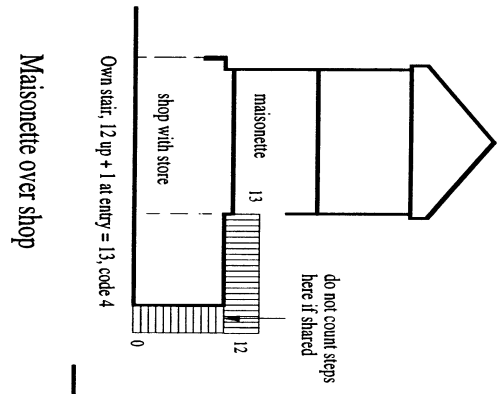

Maisonette over shop

Block of flats

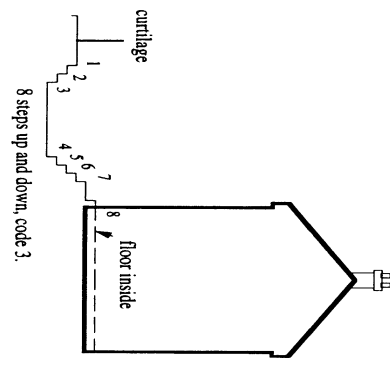

Dwelling house with garden

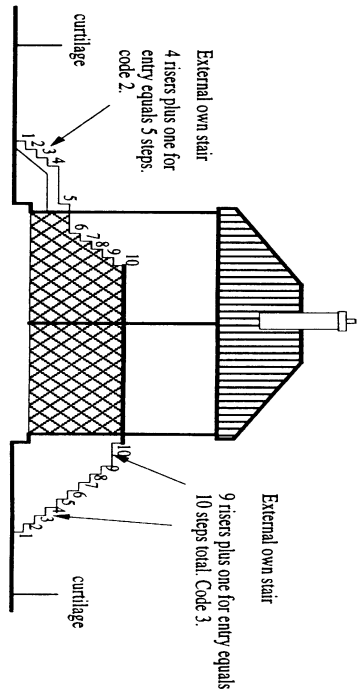

Four in a block options

D5. Is door bell/entry system to dwelling or common block accessible for wheelchair users?

This question assesses the existing access arrangements a wheelchair user would encounter, not the potential arrangements after modifications.

The main entrance being assessed for this question is not necessarily the same entrance as assessed for D2, D3 and D4.

This asks whether a wheelchair user visiting the dwelling would be able to attract the attention of the occupants at the main entrance to the dwelling or common block.

For this item you should consider, within the dwelling or common block curtilage, the suitability of the following:

Changes in Level. Any change in level, prior to the doorway, over 20mm renders the dwelling unsuitable for wheelchair visitors to attract attention at the main entrance. A step in line with the doorway itself is acceptable.

Gates / gaps. Minimum 850mm wide.

Paths. Minimum 900mm wide and hard standing.

Path Gradients. No steeper than 1:12.

Level standing at entrance. Minimum Area 900mm x 1m depth at entrance door.

Accessibility of Letterboxes/ Knockers/ Doorbells/ Common Entry Systems.

Letterboxes, door knockers, doorbells and common entry systems are required to be positioned between 900 – 1200mm above the surface a wheelchair would be located at when attracting attention

They must also be within arms reach of the wheelchair location.

Presence of any Wheelchair Lifts within the Common Close. Lifts, if present, should be assessed for their suitability for use by a wheelchair to enable access to the survey dwelling.

The following table illustrates which entrance would be assessed for different dwelling types.

Dwelling type	Entrance Assessed
House	Main entrance to dwelling
4-in-a-block type flats	Main entrance to dwelling
Tenement and Tower/Slab dwellings with a common close and a common entry system	Common block entry system
Tenement and Tower/Slab dwellings with a common close and no common entry system.	Main entrance to dwelling. Any change in level over 20mm would render the dwelling inaccessible to a wheelchair user.

Code 1: NO

The existing arrangements prevent a wheelchair visitor from attracting the attention of the occupants at the main entrance.

Code 2: YES

The existing arrangements at the main entrance are suitable.

Code 8 N/A

There is no letter box, knocker, bell or entry system.

Code 9: UNOBTAINABLE

You are unable to determine if a visiting wheelchair user would be able to attract the occupants' attention.

D6. Presence of porch/conservatory

Please also refer to the surveyor guidance note on how to score a porch/conservatory.

DEFINITION OF A PORCH

Porches are **not rooms** as defined by the SHS physical survey and are not included in the room count at question J1. See room definitions.

A porch:

- Must be attached to and project from the dwelling
- Must be single storey
- Must provide enclosed weather protection to any principal entrance
- Must have a full separating door between the porch and the dwelling
- Can be built at the time of the dwelling or subsequently
- Cannot contain a **room** or a W.C.
- Where more than three-quarters of the area of the roof **and** more than one-half of the area of its external walls is made of translucent material:
 - floor area 8m² or less ...classed as porch
 - floor area greater than 8m² ...classed as a conservatory.

If unheated or heated but separated by a door **do not** include in floor dimensions.

DEFINITION OF A CONSERVATORY

A conservatory:

- Must have more than three-quarters of the area of its roof **and** more than one-half of the area of its external walls made of any clear or translucent material.
- Must be attached to the dwelling.
- Must provide enclosed weather protection

- Must be accessible from the interior of the dwelling
- Need not have a door into the house.
- If separated by a door and unheated **do not** include in floor dimensions
- If not separated and heated **include** in floor dimensions
- Can be built at the time of the dwelling or subsequently
- Where the construction being surveyed complies with the above, the following rule applies.
 - floor area 8m² or less classified as porch
 - floor area greater than 8m² classified as a conservatory.

Conservatories are not included as part of the dwelling measurements (Section N)

Heating arrangements in and the measurements of conservatory are not to be considered here. These are covered in Sections M and Q.

Code 1: NONE

The dwelling does not have either a porch or a conservatory.

Code 2: PORCH ONLY

The dwelling has one or more porches present.

The dwelling does not have a conservatory.

Code 3 CONSERVATORY ONLY

The dwelling has one or more conservatories.

The dwelling does not have a porch.

Code 4: PORCH AND CONSERVATORY

The dwelling has one or more porches **and** one or more conservatories.

Code 8: NOT APPLICABLE

This category is for dwellings where no porch or conservatory presently exists and where it is impractical for either a porch **or** a conservatory to be constructed.

All tenement and tower/slab flats located at first floor level or above should be considered to be in this category.

For ground floor flats and 4-in-a-block type flats you should consider the practicality of construction of either a porch **or** a conservatory. Building on communal or public land is to be considered not practical for the purposes of this question.

Dwellings considered as suitable for construction for either a porch or a conservatory where neither currently exist should be code 1: NONE.

Code 9: UNOBTAINABLE

You are unable to determine if the dwelling has any porches or conservatories present.

D7. Is dwelling suitable for solar panels or photo voltaics?

This question and the two following identifies dwellings that could benefit or are currently benefiting from photovoltaics (PV) and/or solar panels (SP). To benefit from the installation of photovoltaics and/or solar panels, a dwelling must have a roof of sufficient size and appropriate orientation that is not over-shaded by objects that will block out the sun in winter. The three questions provide a combination of answers in conjunction with others and are often interrelated.

NOTE: A dwelling that is suitable for solar panels will also be suitable for photovoltaics as photovoltaics benefit from a wider angle of incidence in their orientation (This determines the hierarchy of question options).

The method of water heating or electricity generation present in the dwelling are not considered here.

ASSESSING DWELLINGS FOR PHOTOVOLTAIC AND SOLAR PANELS

For the purposes of the survey it is assumed that solar panels or photovoltaics can be installed on all suitable roofs. The assessment is of the actual roof of the dwelling being assessed, or that of the block (including tower / slabs) within which the dwelling is located if the dwelling being assessed does not have its own roof (e.g. mid-floor or ground floor flats). You are required to consider the following items:-

1. **Size** of the roof area
2. **Orientation** of all roof areas
3. **Over shading** from adjacent buildings

If the roof area fails on ANY one of these factors the dwelling is unsuitable for solar panels and you should therefore use Code 1: No

1. SIZE

Roof areas must be greater than 8m² to allow the installation of either the photovoltaic panels or the solar panels.

The majority of roof areas will meet this requirement. It is likely that most small hips will be unsuitable, as are most dormers.

2. ORIENTATION

All flat roofs that are **not over shaded** are **suitable** for photovoltaic panels or solar panels.

For a slope to be suitable it must be within a specified number of degrees each side of south (dependant upon whether solar panels or photovoltaic panels are being considered) to ensure the dwelling can benefit from sun or light all year round.

Assessing Orientation

Orientation is assessed using the supplied compass. DO NOT use any other compass.

Always use your compass to assess the orientation of roof slopes. Never rely on your knowledge of the general direction of south. This question will be rigorously checked by Regional Managers as part of their re-surveys of your work.

Important

- All compass measurements are to be taken outdoors;
- Use away from metal objects, such as keys, the spring of the clipboard and cars;
- Hold the compass horizontally;
- Allow the needle to settle before reading;
- Rotate base plate so that the blue arrow printed on the base plate is aligned in the direction of the slope of each roof slope being assessed;
- Rotate ring of the compass with degree markings so that 'N' (North) lines up with the tip of the red needle;
- Read the degree bearing at base of the blue arrow (where "read bearing here" is printed);
- If the degree reading is between 150° – 210° then the dwelling is suitable for solar panels;
- If the degree reading is between 135° – 225° then the dwelling is suitable for photovoltaics.

Diagram D7 shows example roof plans with the orientation directions (shown by the arrows) that you should assess.

3. OVER-SHADING

You should assess if there is over shading from adjacent buildings that are taller than the survey dwelling's roof that would affect any roof areas / slopes otherwise suitable for the installation of solar panels. Adjacent dwellings that are the same height as the roof slope being assessed will NOT over-shade the roof slope.

The buildings to be assessed are only those in the southern direction to the roof slope being assessed. The taller the adjacent building(s) compared to the dwelling roof being assessed, the further away it needs to be to avoid over shading.

Do not consider deciduous trees in this assessment since they lose their leaves in the winter. Coniferous trees however are to be considered.

Code 1: NO

The dwelling's (or block's) roof areas or slopes are not suitable for solar panels or photovoltaics because of orientation or size or over shading.

Code 2: YES, PHOTOVOLTAICS

The dwelling is suitable for photovoltaics only to be installed. The roof slope lies within 135° – 225°. The dwelling is not suitable for solar panels

Code 3: YES, SOLAR PANELS

The dwelling is suitable for solar panels to be installed. The roof slope lies within 150 ° – 210°. By default dwelling suitable for solar panels will also be suitable for PVs.

Code 4: SP ALREADY INSTALLED

Solar panels are already installed at the survey dwelling. This code also includes unusual specialized forms of passive solar collectors such as warm roof units that circulate warm air from behind an enclosed insulation quilt installed on the inside of south facing roofs and concealed pipes hidden behind roof tiles.

Code 5: PV ALREADY INSTALLED

Photovoltaics are already installed on the roof.

Where photovoltaics are present but not on the roof this will be picked up at L3 so should not be scored here

Code 6: BOTH ALREADY INSTALLED

Solar panels and photovoltaics are already installed on the roof.

Where photovoltaics are present but not on the roof this will be picked up at L3.

Code 9 UNOBTAINABLE

You are unable to assess if the dwelling is suitable for solar panels.

Diagram D7

EXAMPLE ROOF PLANS

Arrows indicate orientation direction(s) to be assessed

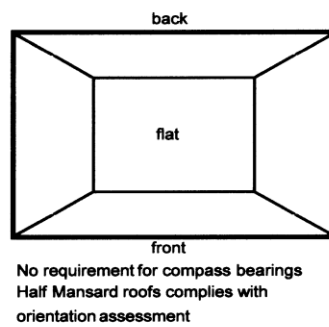
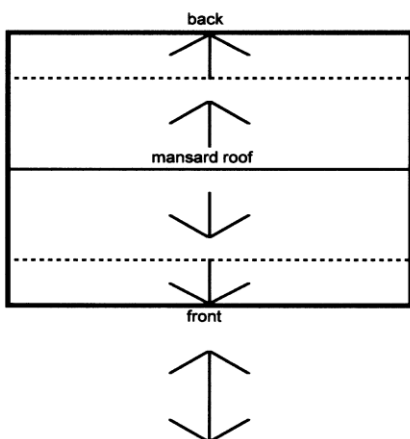
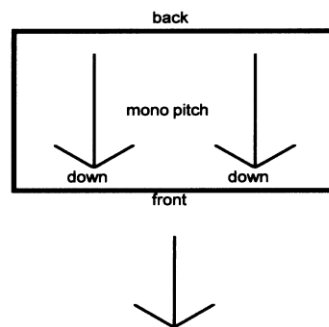
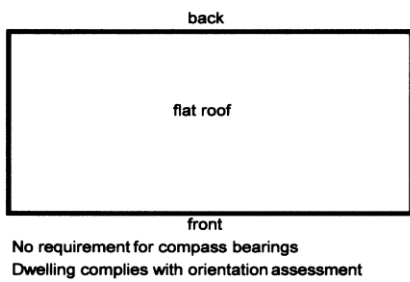
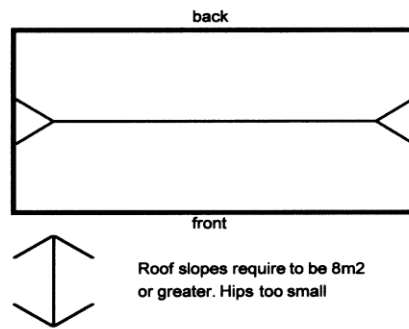
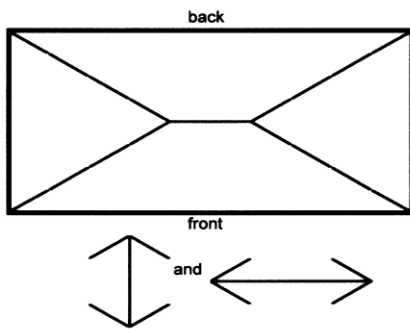
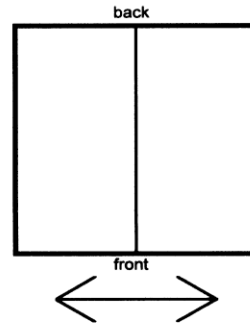
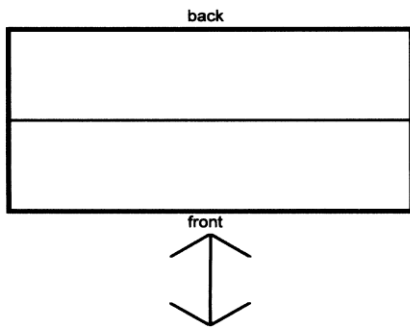

D8. Photovoltaics installed: percentage of roof area

If photovoltaics are already installed in the dwelling roof, then the percentage of roof area covered by the photovoltaics is to be assessed.

Specify: The area of photovoltaics as a percentage of the total roof area (to nearest 10%) is to be scored on the 10 point scale as used for disrepair. There will be no 0 (zero) score as this records only positive values of data:

<15%	Score as 01
15% <25%	Score as 02
25% <35%	Score as 03
35% <45%	Score as 04
45% <55%	Score as 05
55% <65%	Score as 06
65% <75%	Score as 07
75% <85%	Score as 08
85% <95%	Score as 09
95% <100%	Score as 10

Code 88 NOT APPLICABLE

The dwelling does not have photovoltaics already installed.

Code 99 UNOBTAINABLE

You are unable to assess area covered by the photovoltaics.

D9. Solar panels installed: %age of roof area

If solar panels are already installed in the dwelling roof, then the percentage of roof area covered by the solar panels is to be assessed.

Specify: The area of solar panels as a percentage of the total roof area (to nearest 10%) is to be scored on the 10 point scale as used for disrepair. There will be no 0 (zero) score as this records only positive values of data:

<15%	Score as 01
15% <25%	Score as 02
25% <35%	Score as 03
35% <45%	Score as 04
45% <55%	Score as 05
55% <65%	Score as 06
65% <75%	Score as 07
75% <85%	Score as 08
85% <95%	Score as 09
95% <100%	Score as 10

Code 88 NOT APPLICABLE

The dwelling does not have solar panels already installed in the roof.

Code 99 UNOBTAINABLE

You are unable to assess area covered by the solar panels.

D10. Parking provision

You should assess the **existing** provision **NOT** the **potential** provision.

This item covers parking for the use of the occupants of the selected dwelling. It is developed as a decreasing level of ability to park – in the dwelling envelope, in the dwelling curtilage, personal space/garage outside the dwelling curtilage and so on through street parking to the inability to park at or near the dwelling to no parking provision whatsoever.

Code 1: INTEGRAL / ATTACHED GARAGE

The garage is attached to the dwelling, or is integral to the dwelling structure.

Code 2: GARAGE ON PLOT

The occupants have exclusive use of a free-standing garage, or outbuilding suitable for parking, located within the selected dwelling's curtilage.

Car ports are not to be assessed here but should be recorded using Code 3.

Code 3: SPACE ON PLOT

The occupants have exclusive use of an open parking space, or car port, located within the selected dwelling's curtilage.

Code 4: SPACE/GARAGE ELSEWHERE

The occupants have exclusive use of a garage or open parking space, located outwith the selected dwelling's curtilage.

Code 5: ADEQUATE STREET

There is sufficient provision for 1 car per household.

Code 6: INADEQUATE STREET

Inadequate parking provision will be indicated by:

- double parking;
- parking on single or double yellow lines;
- cars parked too near corners (within 3 metres);
- cars parked very close together;
- central parking;
- parking that impedes the flow of traffic or uses adjacent footpaths or pavements due to restricted carriageways.

The occupants do not have exclusive access to any parking provision, anywhere. This includes:

- areas where residents require to purchase a parking permit; and
- "off street" parking areas where there is no exclusive provision.

You must attempt to establish the adequacy of the parking provision within the area. This is most easily established during evening or weekend visits.

When visits to an area take place at a time when it can be assumed that a large proportion of cars are away (daytime during the week) you should assume that there is one car associated with each dwelling and make an estimate on that basis.

Where off-street parking is available it should be assumed that it is used even if there is evidence to the contrary.

Code 7: NO PARKING PROVISION

There is no parking provision outwith the curtilage of the dwelling, on street parking provision, nor any provision within the area identified for this section.

Double yellow/red lines at the kerbside throughout the relevant area and/or where streets are so narrow that to park on them would prevent circulation of traffic or emergency service access.

Note. You should not score “no parking provision” simply because there are no parking bays or car parks. In many situations kerbside parking is possible and can be scored as either adequate or inadequate.

D11. Underground drainage

Code 1: PUBLIC CONNECTION

The selected dwelling is connected to a mains drainage system provided by a public utility.

Code 2: SEPTIC TANK / CESSPOOL

The selected dwelling is connected to either a septic tank or a cesspool:

Septic tank - sometimes identified by vent pipe and outfall to water course, although older tanks have no visible cover or other physical manifestation to indicate their presence.

- newer models may have soakaway or similar.

- reed beds are also coming into use.

Cesspool - identified by large concrete slab with access cover.

Code 3: OTHER

Include here mechanical / bio-chemical systems, (large green or yellow) tanks which act as biological treatment systems.

Code 3 (Other) also covers “Composting toilets”.

Code 4: NO DRAINAGE

The selected dwelling is not connected to any form of drainage system.

Code 9: UNOBTAINABLE

You are unable to determine if the selected dwelling is connected to any form of drainage system.

Section E. Characteristics of Common Block (Flats)

A common block may be defined as a group of two or more dwellings, normally separated horizontally under the same roof, where the cost of repairs to common parts may be apportioned on a dwelling basis. This definition includes mixed uses, where shops, offices or other commercial properties can be apportioned an element of cost on the same proportional basis.

These dwellings may or may not have shared access.

Traditional 4-in-a-block type (detached block of four flats) should be surveyed as a whole.

Where blocks of flats, or linked flat blocks, are built as semi-detached or terraced units, you should choose a group or block of flats (that includes the selected dwelling) served by one common stair or close.

The same criterion is to be used when selecting the smallest repetitive unit where 4-in-a-block types are halved and form ends to blocks. The stair/own door and roof approach should be used as the common denominator.

The group selected is to be used as the basis for all questions on the common block both in this manual and on the survey form.

SEE DIAGRAM E1

SECTION E IS COMPLETED FOR ALL FLATS (REGARDLESS OF THEIR TYPE). SECTION E2-E12 IS NOT COMPLETED FOR ANY TYPE OF HOUSE.

WHERE A BLOCK CONTAINS COMMON ACCESS SECTIONS O & P SHOULD ALSO BE COMPLETED.

E1. Is the dwelling part of a common block?
--

Code 1: YES

The dwelling is a flat in a common block as defined above - Complete Section E.

Code 2: NO

The dwelling is not a flat in a common block. By definition, only houses should be coded 2 - ignore Section E.

Note: Four-in-a-block dwellings are part of a common block and should be scored in Section E, but do not form part of a block with common access and should not be scored in sections O and P.

Houses that are terraced with passage type (C1 code 2) are houses and do not form a part of a common block, (E1 is code 2 – No, and O1 is code 2 – No).

Diagram E1 Common Block

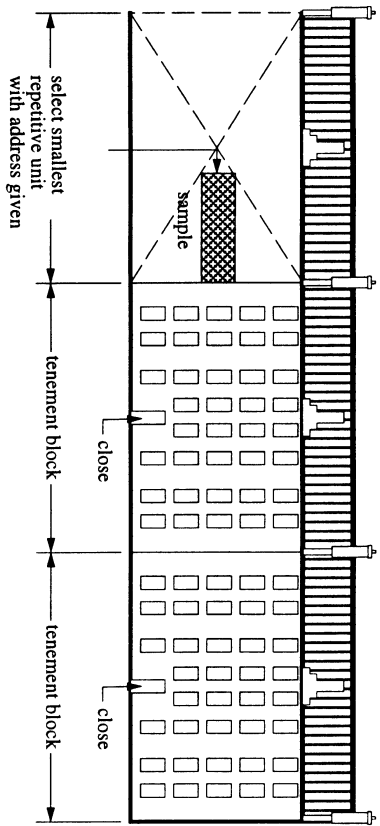

Where stair blocks are not evenly distributed select the nearest to the sample address.
 Select the minimum block in which the dwelling falls.
 Do not survey the whole complex.

This unit is the basis of survey for all form filling

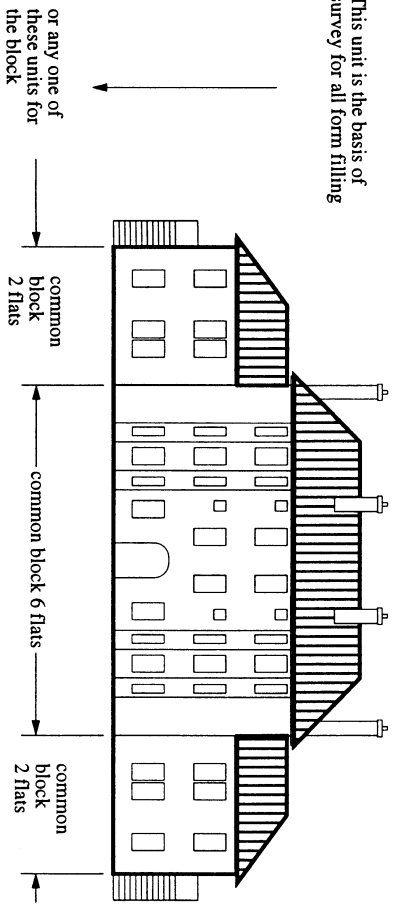

Select common block for examples A. B. C.

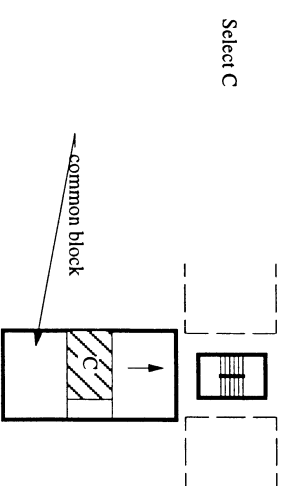
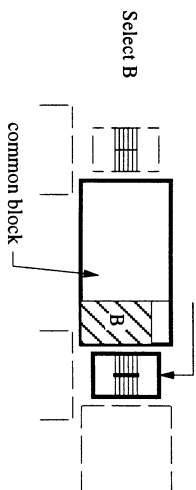
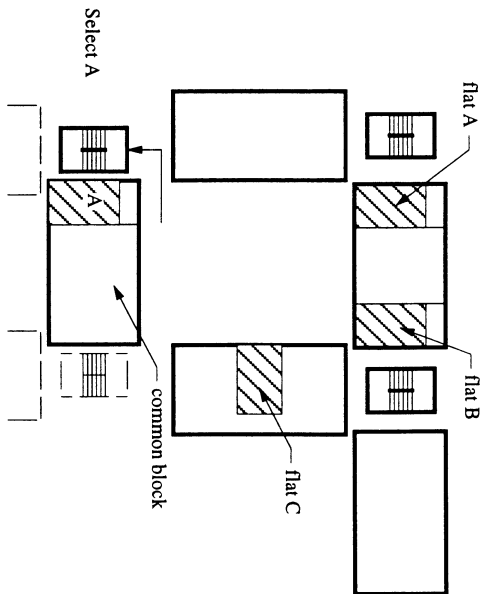

E2. Type of common block (or converted building)

NOTE: These codes apply to both purpose built blocks, converted houses and other common structures.

Code 1: MID TERRACE

A common block situated in the middle of a row of three or more blocks, including blocks containing commercial premises etc. The block being surveyed will therefore have two party walls.

Code 2: END TERRACE

A common block situated at the end of a row of three or more blocks, commercial premises etc. The block being surveyed will therefore only have one party wall.

Code 3: SEMI-DETACHED

A common block sharing one party wall with another block or commercial premises of a similar size.

These two “blocks”, when taken together as a single unit, should be physically separate from other blocks excepting:

- tenuous physical connections, such as the “cross attached” junctions; **DIAGRAM D1**;
- single storey non-habitable link blocks, such as stores and garages, which abut adjoining blocks.

The above arrangements should not prevent a block being classified as semi-detached.

Code 4: DETACHED

A block that is free standing with no party walls. You should ideally be able to walk or see around the entire block. Where this is not possible and blocks almost connect there should be evidence of either:

- an air space; or of
- completely independent structures.

The following arrangement does not prevent a block being classified detached:

- single storey non-habitable link blocks, such as stores and garages, which abut adjoining blocks.

Code 5: CORNER/ENCLOSED END TERRACE

Corner - as mid-terrace (Code 1) but at a junction or turn physically linked to dwellings or commercial premises on either side. Only two exposed external walls.

Enclosed end code also used to describe a back to back end terrace house. Dual aspect dwelling similar to a corner house.

Code 6: ENCLOSED MID TERRACE

Enclosed mid code used to describe a back to back mid terrace common block. There is only a single exposed wall to the block and three shared walls

E3. Does the common block contain a non-residential use?

NOTE: Common laundry facilities are not to be considered as a non-residential use.

Code 1: NO

The whole of the common block is in residential use. This includes associated domestic uses such as occupiers' facilities (such as an office or flat belonging to a concierge), residents' car parking and open pedestrian areas beneath blocks of flats.

Code 2: YES

There is a non-residential use somewhere in the common block. This may take the form of:

- shops;
- offices; or
- other commercial premises.

Code 9: UNOBTAINABLE

You should make every effort to determine whether there is any evidence of a non-residential use anywhere in the common block.

Unobtainable should only be recorded where you are prevented from gaining views of the whole block and where there is reasonable doubt regarding the presence of non-residential uses.

E4. Is flat located directly above shops, offices or other commercial premises?**Code 1: NO**

The dwelling is a flat but is either:

- part of a block that does not contain any shops, offices or other commercial premises;
- not the dwelling directly above the shop, office or other commercial premises in a block where such premises exist i.e. there is another dwelling(s) in between.

Code 2: YES

The dwelling is a flat and it is located directly above shops, offices or other commercial premises. Dwellings below commercial premises are not recorded separately.

Code 9: UNOBTAINABLE**E5 – E7 Note on completion**

In heat loss terms a house and a flat can be distinguished by whether or not they have a heat loss floor **AND** a heat loss roof.

A heat loss element is one that separates the dwelling from the external environment. If the adjacent space is another dwelling (through a party wall or a shared ceiling/floor) then this is assumed to be heated whether or not it is occupied, and it is therefore **NOT** a heat loss element. Similarly commercial premises are assumed to be heated, and thus shared elements with a dwelling are not considered to be heat loss surfaces. Garages and warehouses are assumed to be unheated, and therefore shared elements with a dwelling are considered to be heat loss surfaces.

A **HOUSE** will have **BOTH** a heat loss floor **AND** a heat loss roof area that encompasses the dwelling plan area.

A **FLAT** will **NOT** have **BOTH** a heat loss floor area **AND** a heat loss roof area that encompasses all of the dwelling plan area. A flat may have both some heat loss floor and some heat loss roof area (see E5 and E6 for descriptions of part exposed floors and roofs) but at least one of the floor or roof constructions will be part shared with another dwelling.

E5. Flat only, floor exposure

The following answer categories help determine the amount of heat lost through the floor of a dwelling by assessing whether or not the floor is in direct contact with the ground or the external air or is a non-heat loss floor.

NOTE: Diagram E7 (all figures) illustrates some examples of different flats with an indication of their floor and roof exposures.

Code 1: GROUND FLOOR

A ground floor flat is a flat where:

- the lowest floor is in direct contact with the ground; or
- there is a solum space beneath it; or
- there is an unused, unheated basement or cellar directly below it. This area may contain the boiler but there will be no habitable rooms or radiators with it. If so, then this area will become the Ground Floor.

Code 2 : EXPOSED (ABOVE GROUND)

A flat has an exposed floor when it is an upper storey (i.e. not on the ground floor) flat where 100% of the floor area is exposed to the external air. Examples of this type of arrangement occur in blocks of flats that are built on stilts or where the whole floor area of a flat overlaps an open space. It may also occur where the whole of the flat is located over an unheated space, such as a garage.

NOTE: The floor area of a maisonette is taken to be the “footprint” area of the dwelling (use the larger floor area if one floor is larger than the other) **not** the sum of the areas of the floor levels.

Code 3: PART EXPOSED (ABOVE GROUND)

As Code 2 except that the area exposed to the external air is less than 100% of the floor area of the flat. This area will be part of an upper storey floor where this extends out over the lower storey of the dwelling, or part of the flat is located over an unheated space such as a garage or an unheated stairwell, close or passageway. For the floor area to be considered **ONLY** Part Exposed, some part of the floor area of the flat must be located over another dwelling, shop or other heated premises.

Code 4: NON HEAT LOSS FLOOR

A non heat loss floor occurs where a flat is located directly above another flat, shop or other heated premises e.g. a mid-level or top floor flat.

Code 8: UNOBTAINABLE**E6. Flat only, roof exposure**

The following answer categories help determine the amount of heat lost through the roof of a dwelling by assessing the exposure of the roof to the external air.

NOTE: Diagram E7 (all figures) illustrates examples of different flats with an indication of their floor and roof exposures.

Code 1: PITCHED ROOF

At least 50% of the plan area of the flat must be exposed to the external environment.

The predominant roof type is pitched i.e. must have a minimum 10 degree slope.

Typically top floor flats with a pitched, mono-pitched, mansard or half mansard roof. A flat built within a mansard roof would fall within this category.

Code 2: FLAT ROOF

At least 50% of the plan area of the flat must be exposed to the external environment.

The predominant roof type is flat i.e. must have a maximum 10 degree slope.

Typically top floor flats with a flat roof.

Code 3: PART EXPOSED

A part exposed roof occurs when the structure of a lower storey flat extends beyond the structure of the flats above.

A flat located below another flat that has been built into the roof area (regardless of whether the roof is pitched, flat or mansard), may fall into this category, depending upon whether or not the floor area of the upper flat extends over all of the ceiling area of the lower flat.

If the floor area of the upper flat does extend over all of the ceiling area of the lower flat then the lower flat would be recorded as having a non-heat loss roof (Code 4).

Code 4: NON - HEAT LOSS ROOF

A non-heat loss roof occurs where a flat is located directly below another flat, shop or other heated premises e.g. A basement, ground or mid-level flat.

The flat does not project beyond the flat, shop or other heated premises above and consequently does not have an external roof.

Code 8: UNOBTAINABLE

E7. Flat only, wall exposure

SEE DIAGRAM E7 (ALL FIGURES)

For the purpose of this question it is assumed that each flat has four main elevations.

Walls are considered exposed if they separate the dwelling from the external environment.

A wall that separates the flat from another **heated** space (e.g. dwellings or shops) is not exposed. Common stairwells, closes or passageways must have a form of heating present (e.g. a radiator), for the walls that separate them from the flat to be considered as **not** exposed. A common doorway to the close or stairwell entrance or a secured entry system do not fulfil this criteria.

A wall that separates the flat from an **unheated** space should be treated as half exposed. For example this could include an **unheated** enclosed or integral garage, an **unheated** stairwell or lift shaft, an **unheated** close or an **unheated** passageway.

Where the elevation is only partially exposed, the exposed wall count will fall between two integers. This possibility has been catered for by Codes 2, 4 and 6.

For flats with a shared access contained within a common block, e.g. tenements remember to consider the heat loss properties of the internal walls backing onto common close, stairwells and lift shafts.

Where the close is open to the external air, these walls are exposed walls.

Where the close is unheated, these walls are partially exposed.

Where the close is heated, these walls are non-heat loss walls and are ignored.

Diagram E7

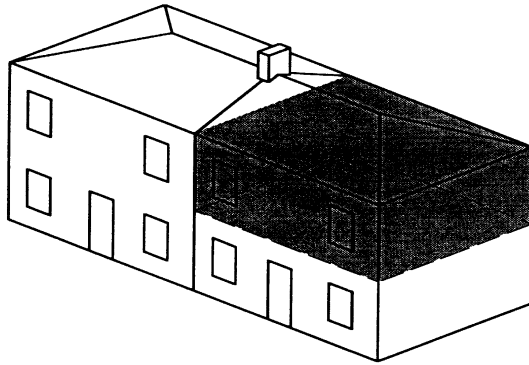

Upper Floor Flat
Built Form: *Flat*
Flat Type: *Block (up to 5 storeys)*
Floor Exposure: *Non-heat Loss Floor*
Roof Exposure: *Exposed Pitched Roof*
Wall Exposure: *Three Walls Exposed*

Lower Floor Flat
Built Form: *Flat*
Flat Type: *Block (up to 5 storeys)*
Floor Exposure: *Ground Floor*
Roof Exposure: *Non-heat Loss Roof*
Wall Exposure: *Three Walls Exposed*

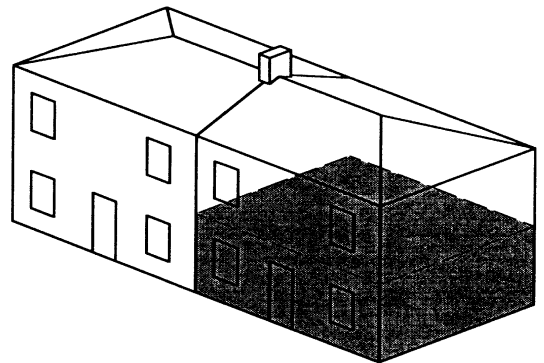

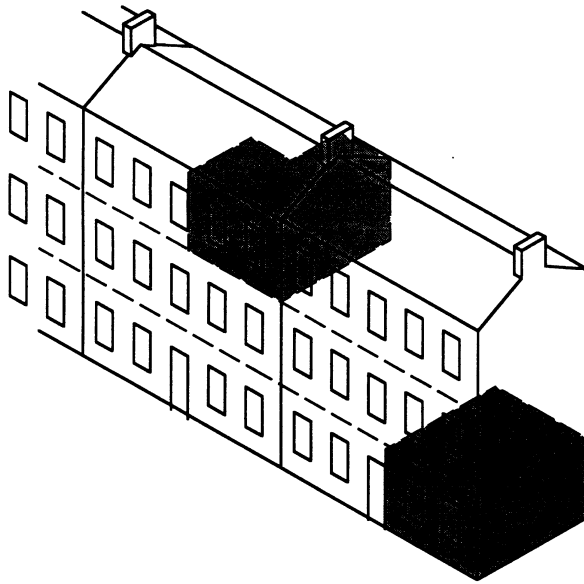

Upper Floor Flat
 Built Form: *Flat*
 Flat Type: *Block (up to 5 storeys)*
 Floor Exposure: *Non-heat Loss Floor*
 Roof Exposure: *Exposed Pitched Roof*
 Wall Exposure: *Between Two and Three walls*
Exposed (if unheated close)
Between One and Two walls
Exposed (if heated close)

Ground Floor Flat
 Built Form: *Flat*
 Flat Type: *Block (up to 5 storeys)*
 Floor Exposure: *Ground Floor*
 Roof Exposure: *Non-heat Loss Roof*
 Wall Exposure: *Four Exposed Walls*
(if unheated close)
Three walls exposed
(if heated close)

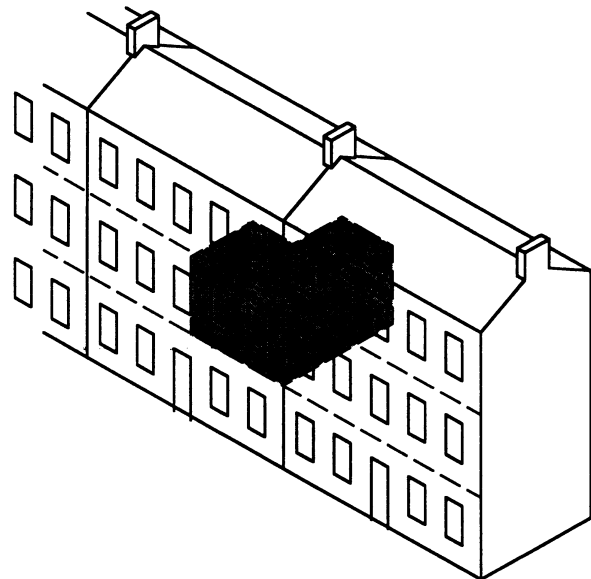

Mid Floor Flat
 Built Form: *Flat*
 Flat Type: *Block (up to 5 storeys)*
 Floor Exposure: *Non-heat Loss Floor*
 Roof Exposure: *Non-heat Loss Roof*
 Wall Exposure: *Between Two and Three Walls*
Exposed (if heated close)
One and Two walls
Exposed (if heated close)

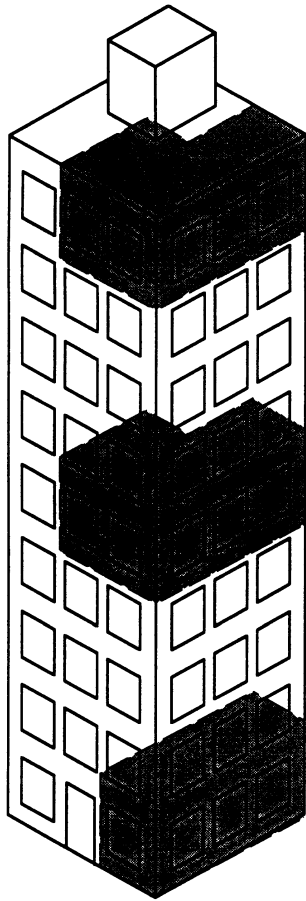

Top Floor Flat
 Built Form: *Flat*
 Flat Type: *Tower Block (>5 storeys)*
 Floor Exposure: *Non-heat Loss Floor*
 Roof Exposure: *Exposed Flat Roof*
 Wall Exposure: *Between Three and Four Walls Exposed (if unheated close)*
Between Two and Three Walls Exposed (if heated close)

Mid-Floor Flat
 Built form: *Flat*
 Flat Type: *Tower Block (>5 storeys)*
 Floor Exposure: *Non-heat Loss Floor*
 Roof Exposure: *Non-heat Loss Roof*
 Wall Exposure: *Between Three and Four Walls Exposed (if unheated close)*
Between Two and Three Walls Exposed (if heated close)

Ground Floor Flat
 Built form: *Flat*
 Flat Type: *Tower Block (>5 storeys)*
 Floor Exposure: *Ground Floor*
 Roof Exposure: *Non-heat Loss Roof*
 Wall Exposure: *Four Walls Exposed (if unheated close)*
Three Walls Exposed (if heated close)

Upper Mid-Floor Flat
 Built Form: *Flat*
 Flat Type: *Tower Block (>5 storeys)*
 Floor Exposure: *Non-heat Loss Floor*
 Roof Exposure: *Non-heat Loss Roof*
 Wall Exposure: *Two Walls Exposed (if unheated close)*
One Wall Exposed (if heated close)

Lower Mid-Floor
 Built Form: *Flat*
 Flat Type: *Tower Block (>5 storeys)*
 Floor Exposure: *Non-heat Loss Floor*
 Roof Exposure: *Non-heat Loss Roof*
 Wall Exposure: *Between Two and Three Walls exposed (if unheated close)*
Two Walls Exposed (if heated close)

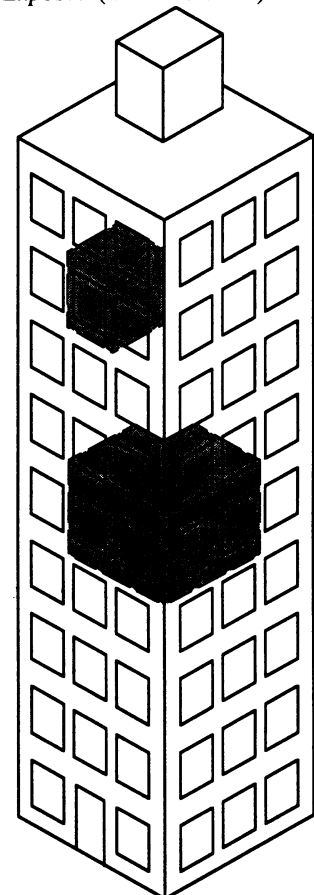

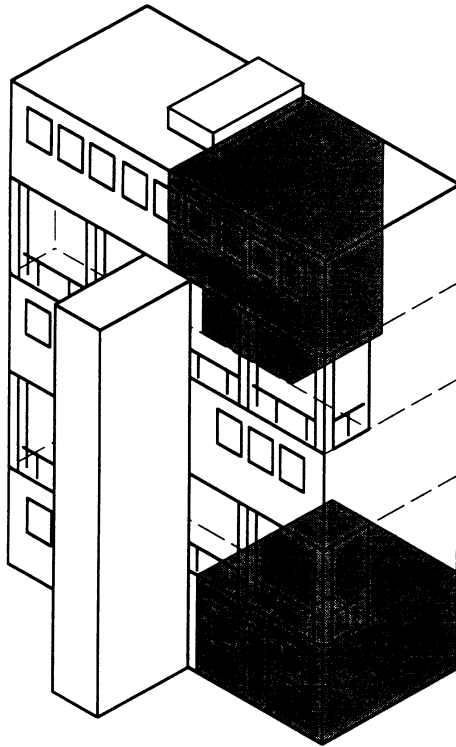

Upper Floor Maisonette
 Built Form: *Flat or Maisonette*
 Flat Type: *Block (up to 5 storeys)*
 Floor Exposure: *Part Exposed Floor*
 Roof Exposure: *Exposed Flat Roof*
 Wall Exposure: *Two Walls Exposed*

Ground Floor Flat
 Built Form: *Flat or Maisonette*
 Flat Type: *Block (up to 5 storeys)*
 Floor Exposure: *Ground Floor*
 Roof Exposure: *Partially Exposed Roof*
 Wall Exposure: *Three Walls Exposed*

Upper Floor Maisonette
 Built Form: *Flat or Maisonette*
 Flat Type: *Block (up to 5 storeys)*
 Floor Exposure: *Part Exposed Floor*
 Roof Exposure: *Exposed Flat Roof*
 Wall Exposure: *Three Walls Exposed*

Mid-Floor Maisonette
 Built Form: *Flat or Maisonette*
 Flat Type: *Block (up to 5 storeys)*
 Floor Exposure: *Part Exposed Floor*
 Roof Exposure: *Partially Exposed Roof*
 Wall Exposure: *Three Walls Exposed*

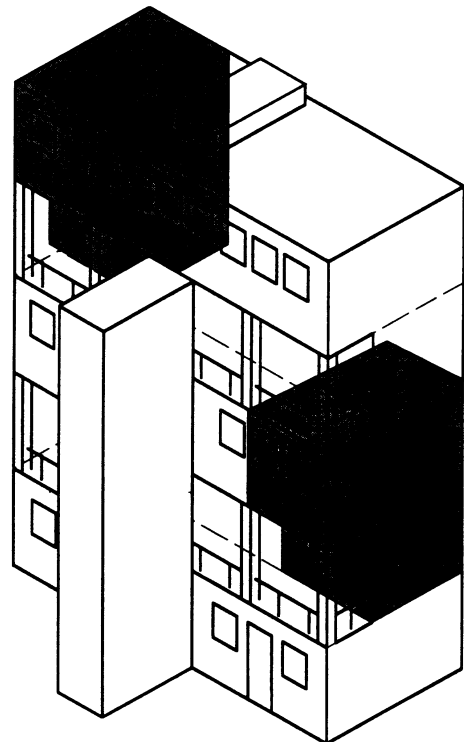

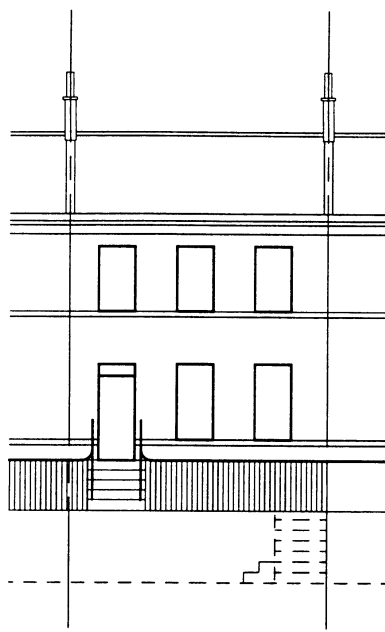
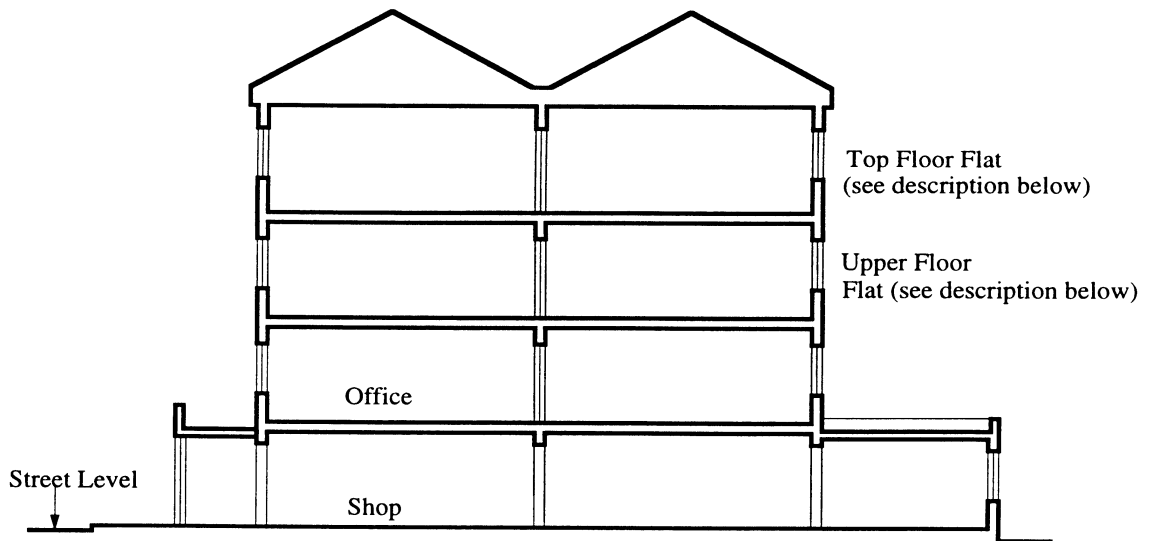

Elevation

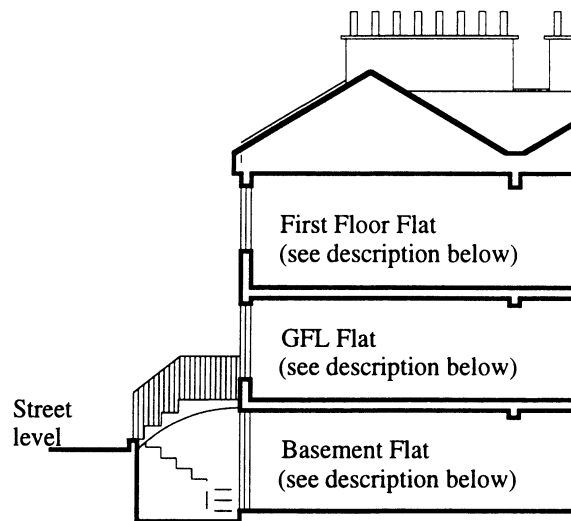

Section

E8. Is any dwelling wall adjacent to corridor/close?

Code 1: YES, UNHEATED CORRIDOR/CLOSE

Code 2: YES. HEATED CORRIDOR/CLOSE

Code 8: NOT APPLICABLE, NO CORRIDOR/CLOSE

There is no corridor/close or no wall of the surveyed dwelling is adjacent to the close/corridor

Code 9: UNOBTAINABLE

E9. Length of wall adjacent to corridor/close (to nearest metre)

SPECIFY: Specify here the length of the wall (in metres to the nearest metre).

Code 888: NOT APPLICABLE

There is no corridor/close or no wall of the surveyed dwelling is adjacent to the close/corridor

Code 999: UNOBTAINABLE

E10 – E12 Note

NOTE: Use leading zeros when recording blocks with fewer than 100 dwellings or 10 storeys.

E10. Number of actual dwellings in the common block

SPECIFY: Specify here the actual number of dwellings in the common block. Do not adjust for other uses (shops, offices etc.) or voids in the common block.

Code 999: UNOBTAINABLE

E11. Estimate equivalent number of dwellings in the common block (Floor area basis)

SPECIFY: Specify here the number of dwellings, equivalent in size to the selected dwelling, that could be accommodated within the main shell of the common block.

The equivalent number of flats in the common block is required in order to allow the correct apportioning of costs between units.

Do not include in this estimate the area associated with:

- any ground floor commercial extensions at the front or rear;
- ground floors of blocks or towers designed to be open circulation space;

- flats belonging to the concierge;
- communal laundries.

Code 999: UNOBTAINABLE

E12. Number of storeys in the common block

NOTE: SEE DIAGRAM E12

SPECIFY: All habitable floors in the block are to be counted together with habitable basements, void floors at ground level and floors in commercial use.

If the top floor is located in a roof (even if only in part use) count as a full storey. Where a common block has different roof levels count to the topmost storey.

Code 99: UNOBTAINABLE

Diagram E12

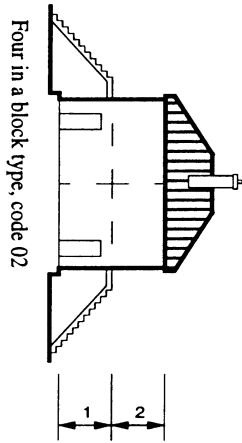
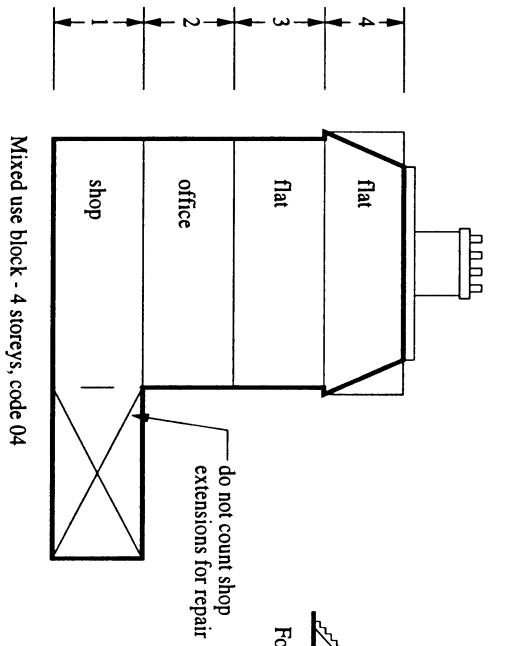
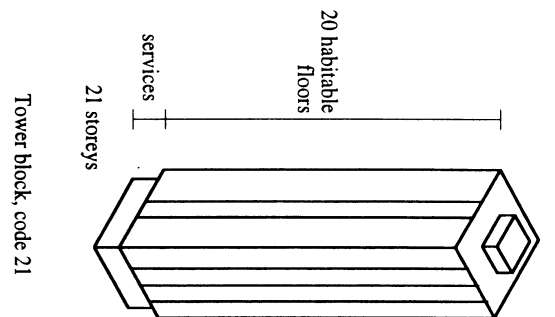
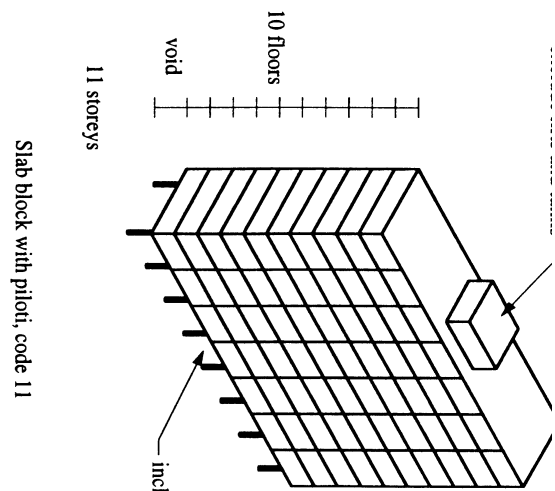
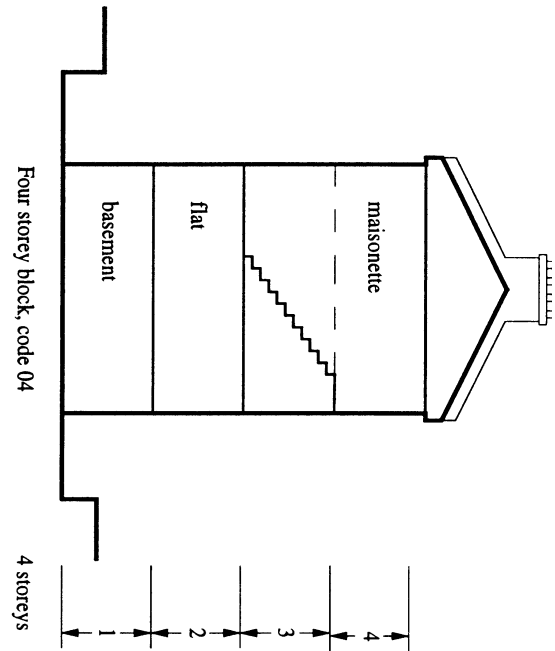

always take the highest level

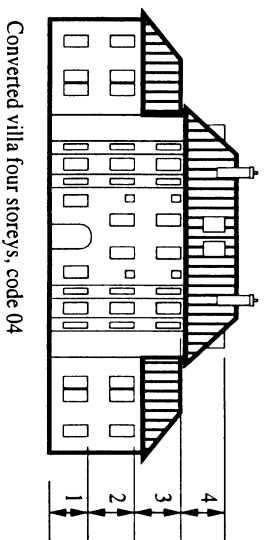

Section F. Characteristics of Common Block (Flats)

Definition of a habitable room

For the purposes of this survey, a habitable room must have a floor area of at least 4.65 square metres (50 square feet) and the ceiling height must be a minimum of 2 metres high for at least 50% of the minimum floor area (2.3 square metres).

The room should also have some provision for some natural ventilation and lighting no matter how inadequate.

Note on completing Sections F, G, H, I and J

Sections F, G, H, I, and J cover the internal inspection of all habitable rooms together with the kitchen, bathroom and hall in a house or flat. They record the location, use, state of repair and presence of defects on a room by room basis.

Repair scores and defects are to be recorded directly into the answer boxes that are arranged as vertical columns for each room.

Where there are **MORE than six rooms** (including the kitchen) in a dwelling, you should survey a selection that is representative in terms of condition of all the rooms in the dwelling. You should therefore not select all the best or all the worst rooms in a dwelling.

In dwellings with more than one level, you should select rooms for survey on each floor on a pro-rata basis. The total number of rooms in the dwelling is recorded elsewhere at J1.

Where there are **six rooms or FEWER** (including the kitchen) in a dwelling, you should complete the room answer boxes in a left to right sequence, starting with the solid line at the left of the sheet. This approach includes any "9"s (unobtainable) that can be included amongst rooms where access has been obtained. Any "8"s (no room) will therefore be grouped to the right hand side of the sheet and not interspersed amongst the occupied rooms or code "9"s.

NOTE: In dwellings with six rooms or less, Room R1 is the first room on the left of the ground floor after entering the dwelling.

In dwellings with more than six rooms, Room R1 is the first room, from the sample you have taken, that is arrived at during a clockwise "sweep" of the dwelling that starts with the first room on the left of the ground floor.

Rooms R2, R3, R4 and R5 are then identified by continuing this clockwise sweep of the dwelling and, where applicable, proceeding upstairs (where a new clockwise sweep is undertaken, again starting at the left).

SECTION F records data on the type of rooms contained within the dwelling and the level on which they are located.

Refer to side panels of the survey form for a shortened version of the manual descriptions.

SECTION G uses two digit answer codes to record levels of disrepair.

SECTION H uses single digit answer codes to record the presence or absence of defects and the provision of heating, lighting and ventilation.

Refer to side panels of the survey form for a shortened version of the manual descriptions.

SECTION I use two digit answer codes to record levels of disrepair to the whole dwelling.

NOTE: For the purposes of this survey, a habitable room must have a floor area of at least 4.65 square metres and the ceiling height must be a minimum of 2 metres high for at least 50% of the minimum floor area (2.3 square metres).

F1. Room level

This question records the presence or absence of a room and its level relative to the dwelling entrance. **SEE DIAGRAM F1 - ROOM LEVEL**

Code 0: ENTRY LEVEL

This is to be used for the level recorded at D1. Thus the **entrance door to the dwelling**, in the hall (or in a room if no hall), becomes the internal reference point. Rooms at the same level as the entrance door are also recorded code "O".

Code 1: FIRST LEVEL

This category is to be used for all rooms one floor above the entrance door.

Code 2: SECOND LEVEL

This category is to be used for all rooms two floors above the entrance door.

Code 3: THIRD OR MORE

This category is to be used for rooms three or more floors above entrance door.

Code 7: BELOW ENTRY LEVEL

This category is to be used for rooms below the entrance door. This is normally, but is not always, a basement. Details of basements are recorded at J4.

An example of rooms located below the entrance door that are not located within a basement occurs in maisonettes that are entered at the upper level.

Code 8: NO ROOM

The dwelling does not have this number of rooms. This code should be used for boxes towards the right of the room by room repair grid.

Recording an answer code "8" means that the answer code boxes in that column (F2 to H13 inclusive) should be left blank.

Code 9: UNOBTAINABLE

The room exists, but, you have been refused entry by the occupant and therefore a survey cannot be achieved within that part of the dwelling.

Recording an answer code "9" means that the answer code boxes in that column (E2 to H13 inclusive) should be left blank.

NOTE: Rooms at intermediate levels (mezzanines) are to be recorded with the nearest principal floor. Where the intermediate floor is equidistant between two floors it should be recorded with the upper floor.

Diagram F1

(note – all rooms relative to entry level as recorded at D1)

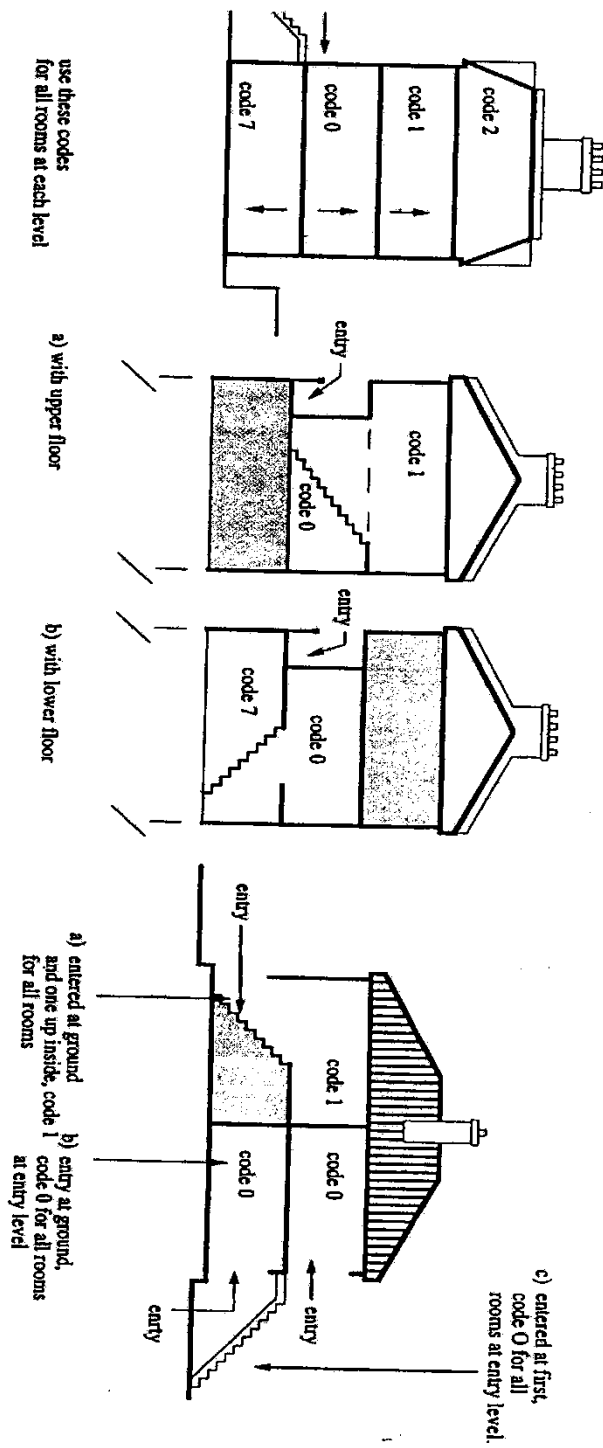

Town house

Cross-over maisonette off deck access

Four-in-a-block entry variations

F2. Room type

Use the following codes for the current use of each room. Where a room is not being used for domestic purposes at the time of your visit it should be recorded as if it was being used for its designed use.

Hall/Landing and Separate WC do not require an answer code at this question.

Code 1: Kitchen only

Code 2: Living room

Code 3: Other public room

Code 4: Bedroom

Code 5: Bath and WC

Code 6: Bath only

Code 7: WC only

NOTE: As the definitions used by the survey require all dwellings to have a kitchen;

- kitchen/Living rooms should be recorded under the heading “**Kitchen**” using codes 2 (living) or 3 (other public);
- bedsits or Single Apartments should be recorded under the heading “**Kitchen**” using code 4 (bed).

Section G. Room repairs

Section G records the presence of disrepair to eight elements/groups of elements within a room on an area or linear basis on the day of the survey (do not anticipate future disrepair). Any disrepair to an element, or group of elements, is to be considered in terms of a percentage of the total amount of that element present within the room being surveyed. This disrepair is scored using the 10 point scale.

Where the room exists and is inspected, you should code each answer box within Section G using a value from "00" - "10", "88" or "99" to indicate the extent of repair for the element defined in the question.

At a basic level, answer codes 55, 01, 02, 03, 04, 05, 06, 07, 08, and 09 represent elements that have 2.5%, 10%, 20%, 30%, 40%, 50%, 60%, 70%, 80%, or 90% disrepair. However, these answer codes should also be treated as the mid points of bands of disrepair.

Therefore:

Code "00"	element(s) in good repair requiring no remedial work
Code "55"	covers repairs less than 5%;
Code "01"	covers repairs in the range 5% to less than 15%;
Code "02"	covers repairs in the range 15% to less than 25%;
Code "03"	covers repairs in the range 25% to less than 35%;
Code "04"	covers repairs in the range 35% to less than 45%;
Code "05"	covers repairs in the range 45% to less than 55%;
Code "06"	covers repairs in the range 55% to less than 65%;
Code "08"	covers repairs in the range 75% to less than 85%;
Code "09"	covers repairs in the range 85% to less than 95%;
Code "10"	represents disrepair requiring renewal of 95% or more;
Code "88"	indicates there is no element (Not Applicable);
Code "99"	indicates that there is an element but the surveyor is unable to make an assessment (unobtainable).

NOTE ON SCORING DISREPAIR

You must undertake your assessment of **each element in isolation** and must not take account of associated work to other elements. To illustrate this point, a room that has a serious failure of a floor structure which is recorded with "05" at G1, may have "00" recorded against G2 if there is no damage to the floor finish. The computer program used by the Scottish Government to establish the cost of work has an in-built allowance for the cost of associated work and therefore recording associated work separately, where it is not justified in its own right, will result in double-counting.

Your assessment of the area of the element in disrepair can either reflect **one occurrence** of a defect **or the aggregate area of two or more defects**.

No Room and Room Unobtainable (Codes 8 and 9) at F1 will result in the answer boxes in the columns (G1 – G8) under those codes being left blank.

G1. Floor structure

Where the room has a suspended floor, you should assess the length of floor joist that will require to be replaced to remedy any disrepair. This assessment should take into account any cutting back necessary due to the effects of rot or infestation.

Where the room has a solid floor, you should assess the area of floor that will be required to be replaced to remedy any disrepair.

Disrepair is to be assessed on an area basis.

G2. Floor finish

All proprietary finishes including timber, chipboard, concrete screed and tiles (rubber, plastic, ceramic etc.) physically fixed to the floor are to be regarded as floor finish.

Disrepair is to be assessed on an area basis.

G3. Skirtings

Skirtings are assessed on a linear basis.

G4. Wall finish

All proprietary finishes including plaster, timber, chipboard and tiles (rubber, plastic, ceramic etc.) physically fixed to the wall are to be regarded as wall finish.

Wallpaper is not considered here.

Disrepair to wall finish within the room is assessed on an area basis.

G5. Ceiling finish

All proprietary finishes including plaster, timber, chipboard and tiles (rubber, plastic, ceramic etc.) physically fixed to the wall are to be regarded as wall finish.

Wallpaper is not considered here.

Glazed panels in the ceiling should be assessed with G7 Doors and Frames. The assessment of the ceiling should discount the area associated with any such glazed panels.

Roof hatches should be taken as part of the ceiling

Disrepair to the ceiling finish is assessed on an area basis.

G6. Cornices

All proprietary material including timber and plaster. Polystyrene cornices are not considered here as they are decorative.

Disrepair to cornices is assessed on a linear basis.

G7. Doors and frames

Doors should be recorded with the room into which they swing, with the exception of doors that lead outside the dwelling (doors leading into a common circulation space or directly to the external environment: these are recorded in Section P (Repairs to Common Elements) or Section R (External Repairs)).

The different components within “Doors and Frames” have the following percentages of the whole attributed to them:

Door leaf	30%
Frame	50%
Ironmongery	20%

Therefore the replacement of the whole of a door leaf will be recorded as "03" while the replacement of half the ironmongery will be recorded as "01". Elements must be assessed in isolation: the replacement of a door leaf does not automatically require the replacement of the ironmongery associated with it.

Fillets on top of doors resulting from slipped lintels are treated as disrepair.

Doors that require to be rehung should be recorded as "55".

G8. Fireplaces and flues

The different components within “Fireplaces and Flues” have the following percentages of the whole attributed to them:

Fireplaces	20%
Hearth	30%
Fireback up to throat	40%
Surround	10%

The replacement of three-quarters of the fireback up to the throat will be recorded as "03", while the replacement of half the surround only represents 5% of the total value of this answer category and is therefore a borderline "01".

NOTE: Where a blocked up fireplace has been provided with a vent, it should be recorded as "88" (not applicable).

However, a blocked up fireplace that has not been provided with a vent should be recorded as "55".

Section H. Types of defect/condition

Section H records the presence or absence of defects in individual rooms. Where the same defect affects more than one room it should be recorded in each room that it is detected.

Certain questions in this section are linked to the assessment of the dwelling's condition relative to the Tolerable Standard (Section T). As such they should be used as aide memoirs when you come to consider the answers to Section T. At this stage, you should merely record the presence or absence of the defect.

NOTE: Where the question attempts to record the degree of a defect/condition the surveyor's assessment can either reflect one occurrence of that defect/condition or the aggregate area of two or more occurrences of that defect/condition.

No Room and Room Unobtainable, Codes 8 and 9, at F1 will result in the boxes in the columns (H1 - H13) under those codes being left blank.

H1. Is access to room satisfactory?

Code 1: SATISFACTORY

The access to the room is satisfactory. Rooms that can be accessed from two points need only have satisfactory access from one point to comply (Code 1).

Access through a **public** room (living room, kitchen, dining room etc) is satisfactory.

Code 2: THROUGH ANOTHER ROOM

Sole access to the room being surveyed is through a **PRIVATE** room (bedroom).

This arrangement is permissible in dwellings with only one bedroom where surveyors should record Code 1 (satisfactory).

Bathrooms located directly off living rooms are **NOT** to be recorded as having unsatisfactory access.

Code 3: INADEQUATE FIXED ACCESS

The sole access to the room is by means of:

- a staircase that is too steep (as a "rule of thumb" if it feels too steep, it is too steep);
- too narrow, or which winds too tightly, to permit safe and easy access;
- a staircase over 16 risers without an intermediate landing;
- a staircase that does not have landings at both its top and bottom;
- a staircase that does not have at least one hand rail along its full length;

- a circulation space that otherwise restricts access (<2m headroom etc.). Door openings should be assessed with the room to which they provide access.

An example of suitable specifications relative to private stairs is:

- max allowable riser 220mm;
- min allowable going 225mm;
- maximum pitch 42°;
- the going 270mm in from the narrow end of winders must not be less than the going on the straight flights;
- the narrowest point on a winder must not be less than 75mm;
- min allowable width 800mm, except when serving a single room and/or sanitary accommodation when the width can be 600mm.

These specifications have not changed substantially over recent years and therefore surveyors may refer to these criteria when assessing post 1960 - dwellings.

Code 4: OFF WINDER

The sole access to the room is directly off the winders of a staircase. There is no landing/half landing or other platform immediately outside the door to this room.

H2. Is arrangement of room or area satisfactory?

Code 1: SATISFACTORY

The arrangement of the room or area being surveyed is satisfactory.

Code 2: INADEQUATE SPACE

This category is intended mainly for kitchens, which must have a floor area of at least 4 square metres.

Code 3: UNSUITABLE LAYOUT

The room or area being surveyed has an unsuitable layout that restricts its use or represents a hazard to the occupants.

The walls opposite each other within a kitchen must be a minimum of 2m apart.

Bathrooms must allow for a safe and satisfactory arrangement and use of fittings.

Code 4: SPACE AND LAYOUT

The room or area being surveyed suffers from both inadequate space and an unsuitable layout.

H3. Is the room structurally stable?

You should inspect each room to see if it shows evidence of structural instability in the walls and/or ceiling and/or floor.

For the purposes of this question instability is required to be ongoing ie. the condition of the structure will deteriorate if no remedial measures are undertaken. Structural problems that happened in the past (evidence of which is still present) but which have now stabilised should not be recorded.

NOTE: A **single** failure against this question for any room will cause the whole dwelling to fail the Tolerable Standard and should be recorded with a Code 2 at T1.

H4. Is the room free from dry/wet rot?

You should look for obvious signs of rot, but you are not expected to lift carpets or floorboards.

NOTE: **Where surveyors record the presence of dry or wet rot they should also record disrepair against the affected element.**

Where evidence remains of dry/wet rot that has since been successfully treated, you should not record the presence of dry/wet rot and should therefore use Code 1 (Yes - room is free of dry/wet rot).

H5. Has the room satisfactory provision for natural light?

Satisfactory natural light is taken to mean that there is sufficient natural light for ordinary domestic purposes in good weather conditions.

This should be satisfied by windows that are equal in size to at least 1/20th of the floor area of the room.

Where the window area meets this minimum size, but is not able to provide adequate daylight to the room due to the location of the window or the arrangement of the room the surveyor should use Code 2 (No - the room does not have satisfactory provision for natural light).

As a rough guide, the natural light available within the room can be deemed adequate if you are able to read the survey form (without the use of artificial light) while standing in the middle of the room when there is a good level of daylight outside.

NOTE: You must review the data recorded at this question (H5) in conjunction with that gathered at H6, H8 and H9 in their assessment of the condition of the dwelling relative to the Tolerable Standard. A declaration of BTS (Below Tolerable Standard) will require a majority of the rooms within a dwelling to fail on one or more of the criteria assessed by these questions.

H6. Has the room satisfactory provision for artificial light?

The surveyor should record the presence or absence of a permanent source of artificial light within the room.

The source of artificial light does not have to be electric but should be safe.

NOTE: This question merely records the **presence** of an artificial light source **not its condition** (which is assessed on a whole dwelling basis at L16). Therefore an artificial light source may be in severe disrepair and incapable of working but still recorded here as present, i.e. Code 1 (Yes-the room does have satisfactory provision for artificial light).

You must review the data recorded at this question (H6) in conjunction with that gathered at H5, H8 and H9 in your assessment of the condition of the dwelling relative to the Tolerable Standard. A declaration of BTS (Below Tolerable Standard) will require **several** of the rooms within a dwelling to fail on one or more of the criteria assessed.

H7. Have all opening windows suitable window locks?

You must assess all opening windows present in the room being surveyed for the presence of suitable window locks.

Opening windows include casement, sash and case and louvered windows. 'Night vents' and 'trickle vents' should be disregarded for this question.

Suitable window locks are defined as:

- Locks either manufactured and installed at the time of the window installation or retrospectively fitted;
- Those operated with a removable key.

Surveyors are not required to test the operation of locks, consider their state of repair or whether they are/can be used by the occupants.

The nailing or screwing of window openings and security bars/grilles is not to be considered a suitable method of locking windows and should be ignored.

Window limiters that restrict the distance a window can be opened are not suitable window locks.

The security of patio/ French doors is not to be considered here but under question L12: Do all external door(s) to dwelling have adequate locks?

Code 1: YES

All opening windows in the room have suitable window locks.

NOTE: All windows in the room being assessed must be able to be locked.

Code 2: NO

All opening windows in the room do not have suitable window locks.

Code 8: NOT APPLICABLE

There are no opening window lights in the room.

Code 9: UNOBTAINABLE

The surveyor is unable to assess the suitability of window locks in the room.

H8. Has room satisfactory provision for ventilation?**Code 1: SATISFACTORY NATURAL**

The room receives satisfactory ventilation from a window(s).

An opening area within the window(s) equivalent to at least 1/40th of the floor area of the room is deemed to provide satisfactory natural ventilation to that room. Windows that are designed to open but which do not do so due to over-painting, or due to being nailed or screwed shut, should be assessed for the purposes of this question as originally manufactured.

Code 1 should be used, where, the ventilation requirement of the room is satisfied by an opening area within the window, whether or not a mechanical system is present.

Code 2: SATISFACTORY MECHANICAL

The presence of a mechanical ventilation system (irrespective of its condition) is deemed to provide adequate ventilation to a room.

Code 2 should only be used where a mechanical system is present and where there are no windows to the room or the windows present are not designed to open.

Code 3: SATISFACTORY VENTILATION FROM A COMBINATION

The room has a window(s) part of which opens to the outside (opening area not sufficient to satisfy ventilation requirement) and a mechanical ventilation system.

Code 4: UNSATISFACTORY/NONE

There is no mechanical ventilation system within the room and:

- there is no window; or
- there is no opening area within the window; or
- the opening area is less than 1/40th of the floor area of the room.

You must review the data recorded at this question (H8) in conjunction with that gathered at H5, H6 and H9 in your assessment of the condition of the dwelling relative to the Tolerable Standard. All habitable rooms, plus the kitchen, should have provision for ventilation. Surveyors should use his/her judgement to decide if the provision for ventilation is satisfactory for each individual room

H9. Has room satisfactory provision for heating?

Code 1: YES, CENTRAL HEATING

The room contains a heater that forms part of a heating system, which operates with a central control unit. Individual heaters within a central heating system may or may not be capable of being controlled independently.

The extent of the central heating system within the dwelling is not to be considered here but is recorded at M4.

Code 2: YES, ROOM HEATER

The room contains a fixed room heater that is not part of a central heating system.

This can take the form of a gas, electric or solid fuel fired appliance.

For an electric heater to be classed as a room heater for this code the heater is required to be hard wired. If plugged into a 13 or 15amp socket, use code 3.

Code 3: YES, SOCKET

The room contains a 13 Amp or a 15 Amp power socket or a gas point.

5 Amp power sockets are not considered to be satisfactory.

Code 4: NO

The room does not contain any of the above forms of heating.

NOTE:

You must review the data recorded at this question (H9) in conjunction with that gathered at H5, H6, and H8 in your assessment of the condition of the dwelling relative to the Tolerable Standard. A declaration of BTS (Below Tolerable Standard) will require several of the rooms within a dwelling to fail on one or more of the criteria assessed by these questions.

Note on completing H10 – H13

Questions H10 – H13 record the extent of rising damp, penetrating damp, condensation and mould present within each assessed room and also for the whole dwelling.

You should consider the extent of surfaces affected as a percentage of the total available surfaces.

Extent is assessed using the following 8 point scale:

CODE	Description
Code 0:	Yes, 0%

Code 1:	No, < 2%
Code 2:	No, 2% < 5%
Code 3:	No, 5% < 10%
Code 4	No, 10% < 20%
Code 5	No, 20% < 30%
Code 6	No, 30% < 40%
Code 7	No, 40% and over

NOTE: For questions H1 to H9 code 1 indicates that the dwelling is satisfactory or free from a specified defect. For questions H10 – H13 code 0 indicates the dwelling is free from problems. To highlight this change there is a bold horizontal line between questions H9 and H10.

H10. Is room free from rising damp?

This is assessed on a linear basis on walls.

You must make every attempt to distinguish rising damp from condensation or penetrating damp.

Rising damp generally exhibits some or all of the following characteristics:

- wallpaper peeling away or bubbling/flaking paintwork at low levels;
- lifting floor tiles;
- discoloured patch on wall with a tide mark (can be as high as 1 metre above ground floor level) occurring at a sharp change from wet to dry;
- deterioration of plaster and leeching of salts above skirtings.

NOTE: Rising damp is caused by lack of a DPC, failure in a DPC or the bridging of a DPC. Where rising damp is recorded you should take this into account in your assessment of R12 (External Repairs - DPC).

Where evidence remains of rising damp from a defect that has since been corrected, you should not record the presence of rising damp and should therefore use Code 0 (Yes - room is free of rising damp).

H11. Is room free from penetrating damp?

This is assessed on an area basis on walls and ceilings.

Penetrating damp is usually the result of a defect in the building fabric. It is often indicated by some staining to the surface caused by salts leeching through the materials. Mould may also be present but this is generally caused by cold bridging causing condensation as mould need clean water to grow.

You should note the occurrence of penetrating damp and use it as evidence in your inspection of the exterior of the dwelling/block.

Penetrating damp can occur:

around windows (poor seal, damaged putty);

around doors (poor seal);

on ceilings (missing or cracked roof tile/slate, fault in flat roof, poor flashings, defective gutters or down pipes);

on walls (bridged wall ties, poor brickwork, poor rendering);

on chimney breasts (slipped brick in unused (uncapped) flues or cracked haunching).

This assessment includes Traumatic Damp - damp from a source within the dwelling or an adjacent dwelling. This will normally occur due to leaking pipes, drains, tanks or radiators.

NOTE: Where evidence remains of penetrating or traumatic damp from a defect that has since been corrected, you should not record the presence of penetrating damp and should therefore use Code 1 (Yes - room is free of penetrating damp).

H12. Is room free from condensation?

This is assessed on an area basis on walls and ceilings.

You may ask the occupant about condensation but you must assess the extent based on the evidence showing.

Condensation can occur intermittently and therefore an affected dwelling may be dry at the time of your visit. Mould is generally the best indicator for condensation in these periods.

You should prompt the occupant by asking if condensation occurs on walls or windows but assess the extent by using the extent of mould.

Condensation occurring on glazing is to be disregarded.

H13. Is room free from mould?

This is assessed on an area basis on walls and ceilings.

You may ask the occupant about mould.

Mould growth can occur intermittently and may have been removed (cleaned) at the time of visit. Therefore an affected dwelling may be clean and dry at the time of your visit. You should prompt the occupant by asking if mould growth has damaged:

- clothing;
- bedding;
- carpets; and/or

- furniture.

NOTE: Mould can be attributed most commonly to condensation damp. Therefore, if you record the presence of mould (Codes 1 to 7) then H12 will have also recorded the presence of those conditions (condensation). Where mould is associated with penetrating damp (usually causing condensation through cold bridging) record the mould presence and condensation and damp.

Section I. Repairs to whole dwelling

This section is to be completed on a whole dwelling basis and records data on the **STRUCTURAL** aspects of these components. The plaster and finishes to walls (I1 and I2) are recorded on a room by room basis at G4 (wall finish).

Section I records the presence of disrepair to three elements within the dwelling on the day of the survey (do not anticipate future disrepair). Any disrepair to an element, or group of elements, is to be considered in terms of a percentage of the total amount of that element present within the whole dwelling.

At a basic level, answer codes 55, 01, 02, 03, 04, 05, 06, 07, 08, and 09 represent elements that have 2.5%, 10%, 20%, 30%, 40%, 50%, 60%, 70%, 80%, or 90% disrepair. However, these answer codes should also be treated as the mid points of bands of disrepair.

Therefore:

Code "00"	element(s) in good repair requiring no remedial work
Code "55"	covers repairs less than 5%;
Code "01"	covers repairs in the range 5% to less than 15%;
Code "02"	covers repairs in the range 15% to less than 25%;
Code "03"	covers repairs in the range 25% to less than 35%;
Code "04"	covers repairs in the range 35% to less than 45%;
Code "05"	covers repairs in the range 45% to less than 55%;
Code "06"	covers repairs in the range 55% to less than 65%;
Code "08"	covers repairs in the range 75% to less than 85%;
Code "09"	covers repairs in the range 85% to less than 95%;
Code "10"	represents disrepair requiring renewal of 95% or more;
Code "88"	indicates there is no element (Not Applicable);
Code "99"	indicates that there is an element but the surveyor is unable to make an assessment (unobtainable).

I1. Internal walls / partition(s)

This question refers to the structural element of those walls that separate rooms and passages within the dwelling itself.

NOTE: The structural elements considered here could be constructed from brick, block, timber, concrete etc.

The wall finishes are not considered here as they are assessed in G4.

I2. Party wall(s)

Detached houses should be scored 88 (not applicable) here.

This question refers to walls that separate the selected dwelling from:

- other dwellings;
- from common stairs and passageways; and
- from other uses.

NOTE: The renewal score for the two party walls in a mid-terrace house is "10"; therefore each wall has a total renewal score of "05".

The total renewal score for the party wall in an end-terrace or semi-detached dwelling is "10". The computer program adjusts for dwelling type.

The wall finishes are not considered here as they are assessed in G4.

I3. Staircase(s)

This question refers to any staircases located **inside a dwelling**.

All flights are to be assessed together as a single installation.

The different components of a staircase have the following percentages of the whole attributed to them:

Risers and goings	50%
Stringers	30%
Handrails	20%.

Therefore, the replacement of about half of the risers and goings in a staircase will be recorded as a "02" or "03".

If both I3 (internal) and R18 (external) are used for a "4-in-a-block type" or a "conversion" it is assumed that there are two short flights, one inside and one outside the dwelling.

Section J. Rooms/Floor Summary

Section J records summary information for the dwelling. This information is critical in the calculation of repair costs.

J1. Total number of habitable rooms plus kitchen

SPECIFY: You should record the **total** number of rooms within the dwelling that were designed to form part of the living accommodation. This definition includes all habitable rooms in the dwelling (not just those sampled at F1 in dwellings where the total exceeds six) including:

- living rooms;
- dual purpose rooms, e.g.:
 - living-dining;
 - kitchen-dining;
 - kitchen-living-bedroom (bedsit) etc.
- bedrooms; and
- kitchens or kitchenettes.

Rooms intended to fulfil any of the above uses (whether by original design or by conversion) are to be included in the number recorded, whether or not they are currently put to that use, provided that they meet the SHS definition of a habitable room (a floor area of at least 4.65m² and a minimum ceiling height of 2 metres over at least 50% of the floor area).

You should **NOT** include the following room types in your assessment:

- conservatories;
- bathrooms and toilets;
- storerooms, closets, cupboards or recesses;
- utility rooms;
- sculleries that are no longer used for cooking; or
- halls or landings.

Code 99: This code should be used only where your access is severely restricted, preventing an assessment of the total number of rooms.

NOTE: Refer to Part 3 - Definitions for further details of a habitable room.

J2. Number of habitable floors in the dwelling (excluding the roof)**SEE DIAGRAM J2**

SPECIFY: You should record the total number of floors in the dwelling that contain rooms recorded at J1.

NOTE: For a floor to be habitable it must contain at least one habitable room (even when a fixed staircase is present).

Habitable basements are to be assessed as a whole (one) habitable floor within the dwelling.

Mezzanine levels should be considered as part of the nearest floor level and should **not** be counted as a separate level.

Dwellings where top floor rooms are located in the roof space are to be recorded in J3. Located in the roof space is taken to mean that the head of the external wall is **more than 0.6 metres** below the horizontal ceiling level of the room.

If the head of the external wall is **less than 0.6 metres** below the horizontal ceiling level of the room, the top level should be recorded as a whole (one) level. Dwellings with such an arrangement will therefore be recorded at J2.

Single storey flats which are contained wholly within the roofspace should be recorded as having 0 habitable floors at J2 and record the number of rooms in the roof at J3

Maisonettes where both levels are contained wholly within the roofspace should be recorded as having 1 habitable floor at J2 and record the number of rooms in the upper floor at J3.

For a floor to be habitable there must be a fixed permanent staircase present and it must contain at least one habitable room.

The staircase does not need to meet current building regulations.

Diagram J2

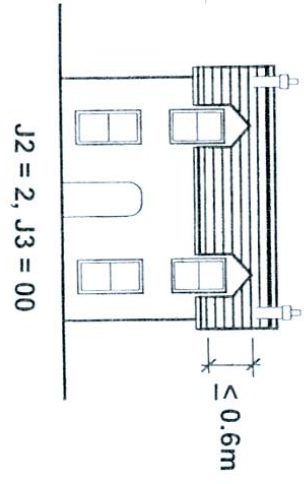
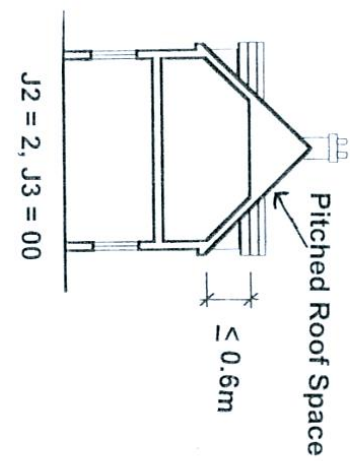
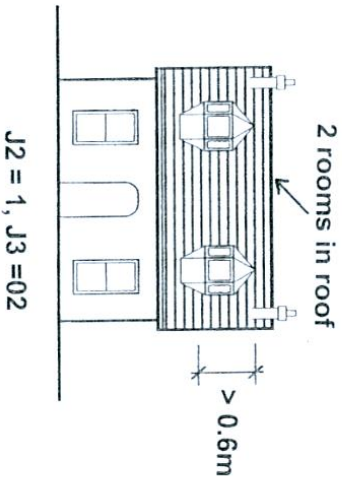
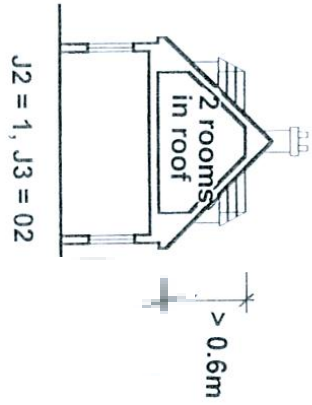
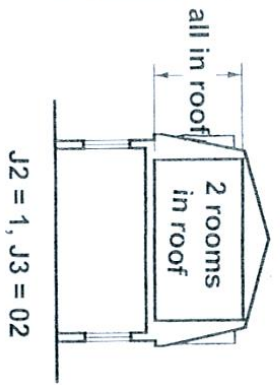
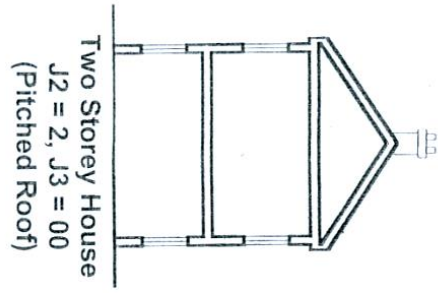

J3. Number of habitable rooms in roof space

Code 00: Where a dwelling has some form of pitched roofspace no matter how small and there are no habitable rooms on the roofspace Code 00.

Code nn The number of rooms in the roofspace

Code 88 **NOT APPLICABLE**

The dwelling has a non-heat loss roof or there is no pitched element to the roof type.

Code 99 **UNOBTAINABLE**

J4. Number of habitable rooms in the basement

SEE DIAGRAM J4

SPECIFY: A basement is a storey which has its lowest floor level at least one metre below the adjacent street or general ground level.

Where a dwelling is on a sloping site, you should project an imaginary line between the ground level at the front and back (or left and right sides) of the dwelling. If the floor level, of the lowest floor in the dwelling, is over one metre below this imaginary line at the centre point of the dwelling then that level is deemed to be a basement level.

Where a dwelling is protected by retaining walls, the lowest floor is to be regarded as a basement level if it is more than one metre below any ground or street level and the retaining walls are within three metres of the edge of the floor.

This definition of basement does not apply if a daylight angle of 45 degrees can be achieved to the edge of the lowest floor level.

For a floor to be habitable there must be a fixed permanent staircase present and it must contain at least one habitable room. **The staircase does not need to meet current building regulations.**

NOTE: For a floor to be habitable it must contain at least one habitable room (even when a fixed staircase is present).

This definition includes all habitable rooms in the dwelling (not just those sampled at F1 in dwellings where the total exceeds six).

Code 88: **NO BASEMENT**

Code 99: **UNOBTAINABLE**

Diagram J4

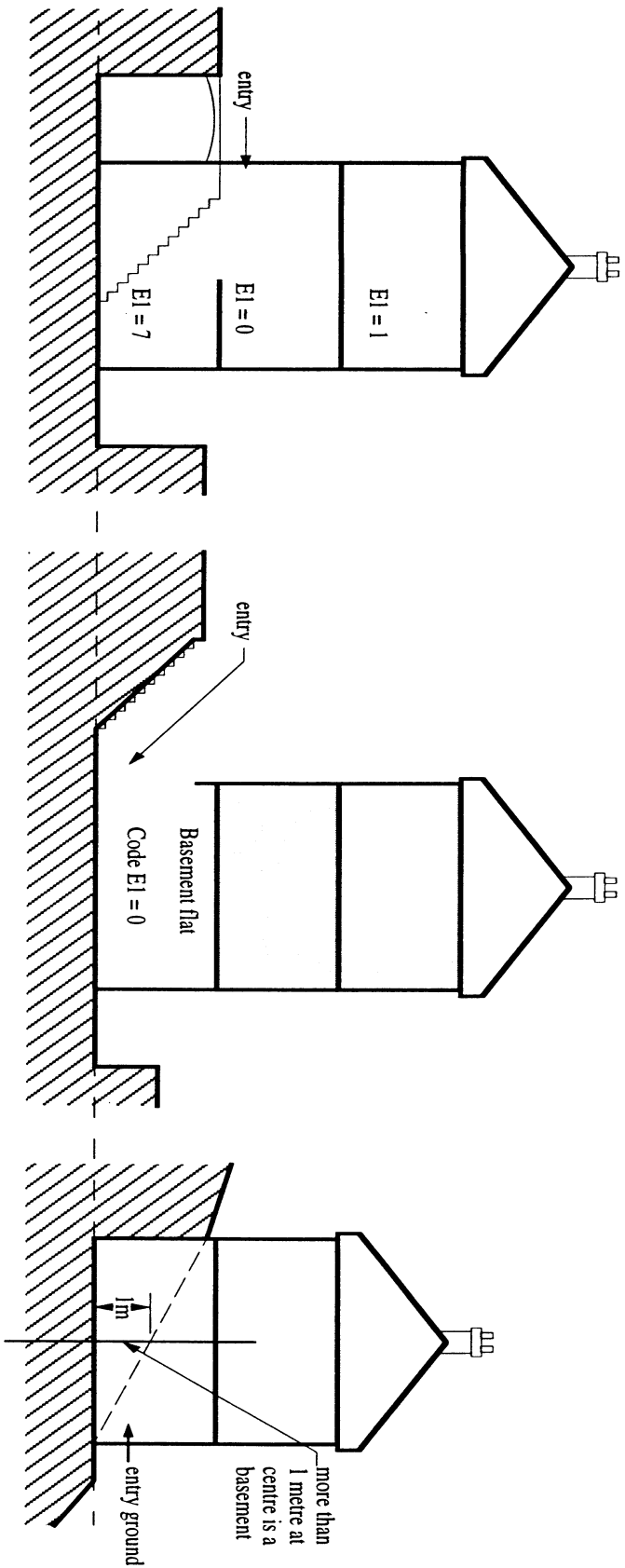

Three storey house
 B7 = 0, entry at ground level
 EI = 7, basement below entry
 I3 = count all rooms at the basement level

Basement flat
 B7 = 7, entry at basement level
 EI = 0, basement at entry
 I3 = count all rooms in the basement flat

Hill-side cottage
 B7 = 0, entry at ground level
 EI = 0, basement at entry level
 I3 = count all rooms at entry as basement level

J5. Does dwelling have a non-residential use?

This question is intended to identify dwellings that contain a non-residential use that cannot be separated from the residential part of the dwelling for the purposes of this survey.

Code 1: NO

The dwelling does not contain a non-residential use.

Where the address issued contains a non-residential use and a self-contained dwelling, you should use Code 1.

Code 2: YES

The following list contains examples of dwellings that should be recorded as having a non-residential use:

- dwellings containing shops;
- dwellings containing rooms used as offices;
- dwellings containing other commercial premises;
- dwellings that are used, either full-time or seasonally, for 'bed and breakfast' accommodation;
- dwellings where a room is used as an office for a professional service;
- dwellings where a catering business is operated from the kitchen.

NOTE: Dwellings that provide 'permanent' bed and breakfast type accommodation to persons with no other home should be recorded using Code 1.

For dwellings containing a non-residential use, you should assess the rooms given over to that non-residential use as if they were dwelling rooms.

Section K. Amenities

This section combines all the questions on amenities (where possible) together with the relevant barrier free questions.

The questions on amenities are to be answered with regard to amenities for the exclusive use of the occupants (not necessarily the same household) of the dwelling.

Where two, or more, internal and exclusive amenities are present within a dwelling you should assess the amenity in the best state of repair.

Bathroom

K1. Where is the bathroom located?

A bathroom is a separate room containing a fixed bath or shower permanently connected to the hot and cold water supply and to a waste water system. It may or may not contain a WC and/or wash hand basin.

This question considers the location of the bathroom not the suitability of the access to it, which is recorded at H1.

Code 1: IN DWELLING

The bathroom is located within the dwelling.

Code 2: IN BUILDING

The bathroom is for the exclusive use of the occupants of the dwelling and is located outside the dwelling, but inside the building (under the main roof).

This will usually take the form of a bathroom located on a common landing or in a back porch.

Code 3: OUTSIDE

The bathroom is for the exclusive use of the occupants of the dwelling and is entered from the outside, via the open air.

The bathroom can be either attached or detached from the dwelling or the block.

Code 4: SHARED BATHROOM

The bathroom is shared with another dwelling.

NOTE: Where the bathroom associated with a dwelling is shared with another dwelling(s) its location is not important and it should be recorded with Code 4. Therefore you should establish that a bathroom is not shared before considering its location.

Bathrooms shared with another dwelling are not to be assessed for repair at K8 and K9.

Code 8: NO BATHROOM

There is no bathroom present, either inside or outside the dwelling.

Code 9: UNOBTAINABLE

You are unable to determine if a bathroom is present.

K2. Where is the main WC located?

The main WC is normally located within or adjacent to the bathroom and is available for use by all household members.

A WC (water closet) is taken to mean a flush toilet discharging into a:

- main sewer;
- septic tank; or
- cesspool.

It does **not** for the purposes of this survey include chemical or earth closets.

Modern environmentally friendly “Composting toilets” complying to American or Swedish standards are to be considered suitable.

This question is concerned with the provision of a WC (either in a separate compartment or within a bathroom - recorded at H1).

The extent of any disrepair is not considered here as that is recorded at K8

This question considers the location of the WC not the suitability of the access to it, which is recorded at F1.

Code 1: IN BATHROOM

The WC is located inside the bathroom compartment, within the dwelling.

Code 2: IN DWELLING

The WC is located in a separate compartment, within the dwelling.

Code 3: IN BUILDING

The WC is for the exclusive use of the occupants of the dwelling and is located outside the dwelling, but inside the building (under the main roof).

The WC may be located within a bathroom or within a separate compartment.

This will usually take the form of a WC located on a common landing or in a back porch.

Code 4: OUTSIDE

The WC is for the exclusive use of the occupants of the dwelling and is entered from the outside, via the open air.

The WC can be either attached or detached from the dwelling or the block.

Code 5: SHARED WC

The WC is shared with another dwelling. The location of the WC is not important in this situation.

NOTE: WCs shared with another dwelling are not to be assessed for repair at K8 and K9.

Code 8: NO WC

There is no WC present.

Code 9: UNOBTAINABLE

The surveyor is unable to determine if a WC is present.

K3. Is the main WC located directly off the kitchen?

This question is included to allow an assessment of the implications of change to the Tolerable Standard.

While you must make your assessment of the dwelling against the revised Tolerable Standard (Section T), this question will allow the number of BTS dwellings under previous definitions to be calculated..

NOTE: This question must be directed to the main WC in the dwelling. The location of second WCs is not to be considered here.

Code 1: NO

The main WC is not located directly off the kitchen.

The main WC is entered from the kitchen **but** not directly, as there is an intervening space. It is not necessary for this space to be ventilated.

Code 2: YES

The main WC is located directly off the kitchen with no intervening space.

Code 8: NO WC

There is no WC located within the dwelling.

Code 9: UNOBTAINABLE

You are unable to determine if there is a WC present within the dwelling.

K4. Is wash-hand basin associated with main WC located with...?

NOTE: Where a dwelling contains more than one wash-hand basin you should answer this question relative to the wash-hand basin most likely to be associated with the use of the main WC.

You must answer this question for wash hand basins only. The kitchen sink is not to be recorded here.

Code 1: WC

The wash-hand basin associated with the use of the main WC is located in the compartment (bathroom or separate WC compartment) containing the main WC.

Code 2: ELSEWHERE

The wash-hand basin associated with the use of the main WC is **not** located in the compartment (bathroom or separate WC compartment) containing the main WC but is located elsewhere within the dwelling.

Code 3: NO WASH HAND BASIN

There is no wash-hand basin within the dwelling.

Code 8: NO WC

There is no WC within the dwelling.

Code 9: UNOBTAINABLE

You are unable to determine if there is a WC present within the dwelling.

K5. Number of WC's within dwelling?

You are asked to count the number of WC's located inside the dwelling for the exclusive use of the occupant.

You should not:

- assess the suitability of their location; or
- consider the location of wash hand basins.

K6 to K10 Note

You should assess the extent of any disrepair to the amenities in questions K6-K10 as a percentage of the total cost of that amenity.

You should record disrepair using the 5 point scale of disrepair.

Code 0:	No repair	0%
Code 1:	Small repairs	up to 5%
Code 2:	Minor repairs	5% to less than 25%
Code 3:	Medium repairs	25% to less than 60%
Code 4	Renew	60% to 100%

K6. Main WC

Surveyors should consider all parts of the WC and its associated plumbing in their assessment, including the:

- cistern, supply pipe and overflow; "3" Medium Repair
- pan; "3" Medium Repair
- cracked or broken seat; "2" Minor Repair
- ballcock and valve "2" Minor Repair
- cistern cover "2" Minor Repair
- ballcock. "2" Small Repair
- loose seat; "1" Minor Repair

K7. Wash-hand basin

Surveyors should consider the following parts of the wash-hand basin;

- basin; "3" Medium Repair
- one tap; "2" Minor Repair
- two (or more) taps "3" Medium Repair
- waste pipe; "2" Minor Repair
- plug and chain. "1" Small Repair

NOTE: The hot and cold supply to the wash-hand basin is assessed separately and is recorded at K8.

K8. Hot and cold to wash-hand basin

You should consider both the hot and cold supply pipes to the wash-hand basin but **not** the taps, which are recorded at K7.

NOTE: Provision must be available (though not necessarily in working order) of both hot and cold water supplies. The provision of only one (or no) supplies must be recorded as Code 8 (no amenity).

An instantaneous water heater of **at least 7 litres capacity** is deemed to be acceptable for the purposes of this question.

K9. Fixed bath/shower in bathroom

You should consider all parts of the fixed bath/shower including

- bath or shower tray/cubicle; "3" Medium Repair
- bath panel or shower screen/curtain; "2" Minor Repair
- one tap; "2" Minor Repair
- two (or more) taps "3" Medium Repair
- overflow and waste pipe; "2" Minor Repair
- plug and chain. "1" Small Repair

K10. Hot and cold to bath/shower

You should consider both the hot and cold supply pipes to the bath/shower but **not** the taps, which are recorded at K7

NOTE: Provision must be available (though not necessarily in working order) of both hot and cold water supplies. The provision of only one (or no) supplies must be recorded as Code 8 (no amenity).

An instantaneous water heater is deemed to be acceptable for the purposes of this question.

Barrier Free

K11. Is the internal circulation barrier free?

The term "Barrier Free" is taken to mean that a person in a wheelchair, or using a walking aid (Zimmer Frame etc.) can:

- Pass through an entrance door to the dwelling.
- This entrance door need not be the front door to the dwelling, but should be the same door recorded at D3 for houses and flats without common access.
- Gain access to a
 - living room OR bedroom;
 - kitchen; and
 - bathroom (must contain WC, wash hand basin, bath or shower)
- All of these rooms will be code 0 (entry level) at question F1: Room Level

To achieve this level of access within the dwelling:

- passages must be at least 900mm wide and free of obstruction from radiators etc;
- doors must be at least 750mm wide.

NOTE: Wheelchair users find it extremely difficult to turn 90 degrees (a right angle) in a 900mm wide passageway to enter a 750mm wide door.

Therefore to be able to enter rooms that require a 90 degree turn:

- the passageway must widen to at least 1200mm opposite 750mm wide doors; or
- the door to the room must be at least 900mm wide.

Only if the internal circulation fulfils these criteria can the dwelling be classified as fully barrier free.

Dwellings where the passageway is not at least 1200 mm opposite a 750mm door can be classified as ambulant barrier free – that is they are in your judgement navigable by a person using a zimmer, walking stick or other walking aid.

These criteria must be satisfied by the access to all of the rooms listed above, not necessarily all of the rooms contained within the dwelling, to be recorded using Code 2 (internal circulation to dwelling is Ambulant Barrier Free) or Code 3 totally Barrier Free.

You should not consider the potential use of a stair lift or other physical conversion of the dwelling. However, you may consider re-designating rooms from their current use in order to comply with the above requirements.

Code 1: NO

The internal circulation areas do not satisfy the above requirements and are therefore not “Barrier Free”.

Code 2: YES, AMBULANT

Internal circulation areas satisfy the above requirements and are Ambulant Barrier Free.

Code 3: YES, FULLY BARRIER FREE

Internal circulation areas satisfy the above requirements and are Fully Barrier Free.

Code 9: UNOBTAINABLE

You are unable to determine if internal circulation areas are Barrier Free.

K12. Is the shortest dimension of the bathroom compartment...?

The purpose of this question is to determine the suitability of the bathroom compartment for use by a person using a wheelchair.

This question addresses the size of the bathroom **not** the existing arrangement of amenities within it.

Code 1: LESS THAN (<) 2100mm

The shortest dimension of the bathroom compartment is less than 2100mm.

The bathroom is too restricted for a wheelchair user to access.

Code 2: GREATER OR EQUAL TO (>=) 2100mm

The shortest dimension of the bathroom compartment is greater than, or equal to, 2100mm but less than 2400mm.

The bathroom allows access to wheelchair users but imposes some restrictions upon their use of it.

Code 3: GREATER OR EQUAL TO (>=) 2400mm

The shortest dimension of the bathroom compartment is greater than, or equal to, 2400mm.

The bathroom allows access and full use to wheelchair users.

This assumes that fittings can be adapted for the needs of the user.

Code 8: NO BATHROOM

There is no bathroom present.

Code 9: UNOBTAINABLE

You are unable to establish if a bathroom is present either inside or outside the dwelling.

K13. Is there a separate WC compartment, within the dwelling, suitable for use by a wheelchair user?

NOTE: For the purposes of this question, an en-suite amenity may be assessed.

Code 1: NO SEPARATE WC COMPARTMENT

The dwelling does not contain a separate WC compartment.

Code 2: NO, NOT SUITABLY LOCATED

Not on entry level

Code 3: NO, TOO SMALL

The dwelling has a separate WC compartment but it is smaller than 1500mm by 1800mm.

Code 4: YES 1500 BY 1800

The dwelling has a separate WC compartment that is at least 1500mm by 1800mm

Code 9: UNOBTAINABLE

The surveyor is unable to determine if a separate WC is present within the dwelling.

K14. Are the locations of power sockets barrier free?

In order to satisfy Barrier Free guidelines, power sockets must be reachable to a wheelchair user or someone with restricted movement.

This is satisfied when:

- power sockets are between 450 and 1050mm above floor level.

When assessing the position of power sockets, you may "pass" dwellings where these are not suitably located throughout all rooms as long as **they are suitably located** within the kitchen, bathroom and one other room and Barrier Free access is available to all these rooms.

Code 1: NO

Power sockets do not satisfy Barrier Free guidelines.

Code 2: YES

Power sockets do satisfy Barrier Free guidelines

Code 8: NOT APPLICABLE

The dwelling does not have an electrical power system.

Code 9: UNOBTAINABLE

You are unable to determine if the power sockets satisfy Barrier Free guidelines.

K15. Are the locations of light switches barrier free?

In order to satisfy barrier free guidelines, light switches must be reachable to a wheelchair user or someone with restricted movement.

This is satisfied when:

- light switches are between 900 and 1050mm above floor level (normal door handle height)

When assessing the position of power sockets, you may "pass" dwellings where these are not suitably located throughout all rooms as long as **they are suitably located** within the kitchen, bathroom and one other room and Barrier Free access is available to all these rooms.

Code 1: NO

Light switches do not satisfy Barrier Free guidelines.

Code 2: YES

Light switches do satisfy Barrier Free guidelines

Code 8: NOT APPLICABLE

The dwelling does not have an electrical lighting system.

Code 9: UNOBTAINABLE

You are unable to determine if the light switches satisfy Barrier Free guidelines.

<p>K16. Are all the primary heating controls accessible for wheelchair users</p>

This question assesses the extent to which the primary heating controls identified in question M20 (Heating controls for primary heating) are accessible by people confined to a wheelchair.

For controls to be accessible they must be 450 – 1050mm above the floor.

Code 1: NONE

None of the primary heating controls identified in M20 are suitable for wheelchair users.

Code 2: SOME

More than one, but not all the primary heating controls identified in M20 are suitable for wheelchair users.

Code 3: ALL

All of the primary heating controls identified in M20 are suitable for wheelchair users.

Code 8: NO CONTROLS

No controls are present to the primary heating system (M20 code 1).

Code 9: UNOBTAINABLE

You are unable to assess if the primary heating controls are suitable for wheelchair users.

<p>K17. Is the area in front of all kitchen worktops and fittings...?</p>
--

The purpose of this question is to assess the usability of the kitchen to wheelchair users.

You should not consider a kitchen refit. Assess fixed kitchen worktops and fittings only. Disregard all furniture, no matter how substantial.

Code 1: LESS THAN (<) 1200mm

The area in front of all kitchen worktops is less than 1200mm.

The kitchen is too restricted for a wheelchair user to access.

Code 2: GREATER OR EQUAL TO (\geq) 1200mm

The area in front of all kitchen worktops is greater than, or equal to, 1200mm but less than 1500mm.

The kitchen allows wheelchair users access and limited use.

Code 3: GREATER OR EQUAL TO (\geq) 1500mm

The area in front of all kitchen worktops is greater than, or equal to, 1500mm.

The kitchen allows wheelchair users access and full use (assuming fittings were to be adapted for their needs).

This category fulfils the requirement for a wheelchair to be able to turn within the working area.

Code 8: NO KITCHEN WORKTOP OR FITTINGS

There are no kitchen worktops or fittings in the kitchen.

Code 9: UNOBTAINABLE

You are unable to gain entry to the kitchen.

K18. What extra kitchen storage provision is required?

SEE DIAGRAM K18

Dwellings should be assessed against the following minimum requirements:

- 1 or 2 person dwellings require 1.7m³ (cubic metres) of kitchen storage;
- dwellings for 3 or more people require 2.3m³ of kitchen storage.

All types of cupboards (walk-in pantries, Edinburgh Presses etc.) can be included in this assessment if they are **shelved** and have a **door**. Open shelving should not be considered. Curtains are to be disregarded.

You are not expected to measure the kitchen storage but should use **Diagram K18** to assist in your estimate.

This question deals solely with the volume of kitchen storage present, not its condition or the suitability of its location, which are dealt with at K26.

- Code 1: 0%** The dwelling has, at least, the minimum volume of kitchen storage appropriate for its size, as outlined above.

- Code 2:** **25%** The dwelling requires a further 25% (of the appropriate amount) of kitchen storage. This equates to:
- a **further** 0.44m³ (25% of 1.7m³) in a dwelling for 1 or 2 persons.
 - a **further** 0.58m³ (25% of 2.3m³) in a dwelling for 3 or more persons.
- Code 3** **50%** The dwelling requires a further 50% (of the appropriate amount outlined above) of kitchen storage. This equates to:
- a **further** 0.85m³ (50% of 1.7m³) in a dwelling for 1 or 2 persons.
 - a **further** 1.15m³ (50% of 2.3m³) in a dwelling for 3 or more persons.
- Code 4** **75%** The dwelling requires a further 75% (of the appropriate amount outlined above) of kitchen storage. This equates to:
- a **further** 1.28m³ (75% of 1.7m³) in a dwelling for 1 or 2 persons.
 - a **further** 1.73m³ (75% of 2.3m³) in a dwelling for 3 or more persons.
- Code 5** **100%** The dwelling has **no** kitchen storage
- Note:** Where you have scored 8 (no amenity) at K26 you should score 5 (100% provision required).
- Code 9:** **UNOBTAINABLE** You are unable to gain access to the kitchen.

1. DIAGRAM K18

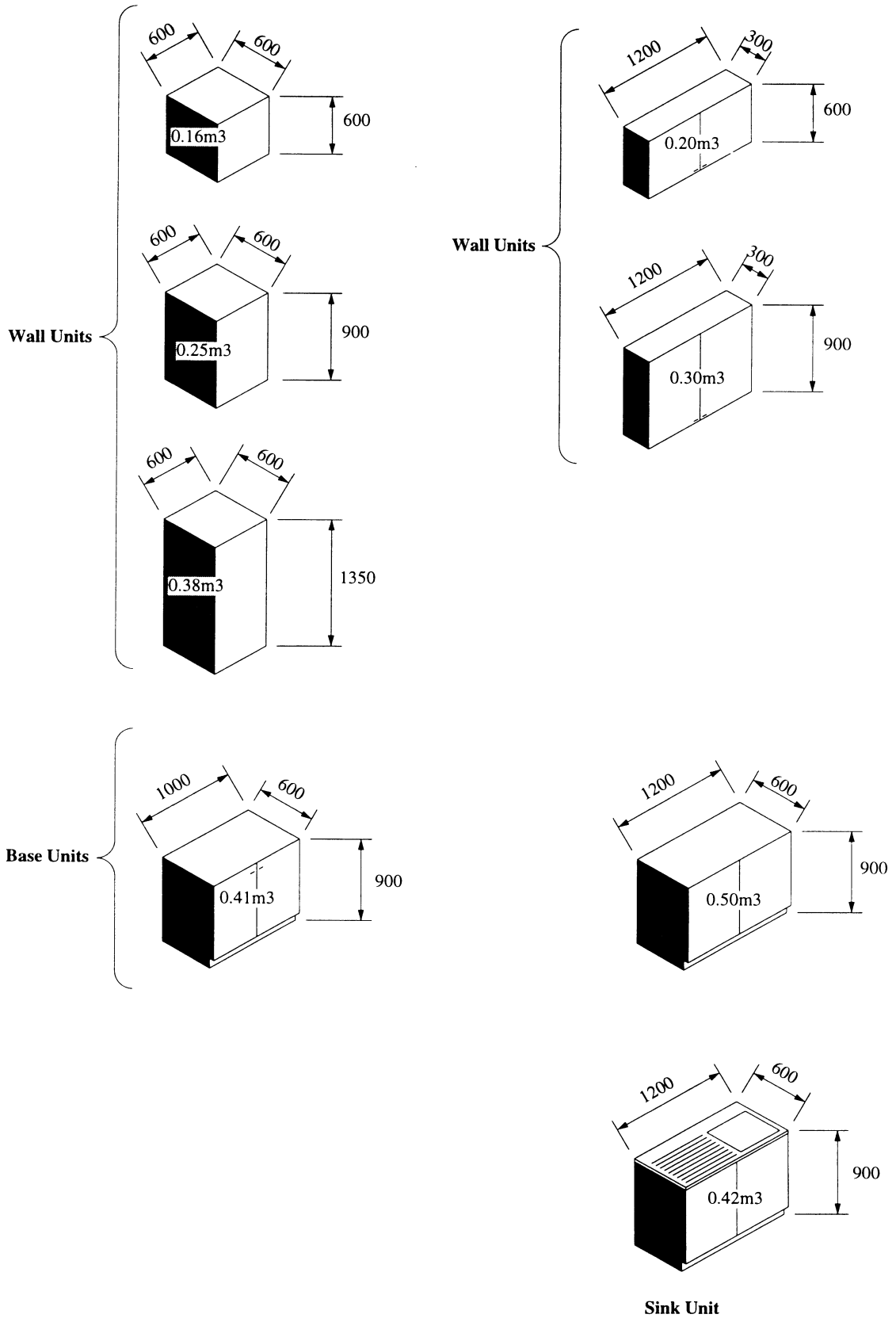

K19. Number of power sockets in kitchen

Code nn: You should record the **total** number of power sockets within the kitchen.

You should include switched spur outlets supplying fridges, washing machines and the like here. Electric cooker (30/45 amp) outlets should not be counted but any 13 amp socket associated with it should be included.

Code 88: **NO POWER SOCKETS IN KITCHEN**

Code 99: **UNOBTAINABLE**

K20. Is there a minimum of 1m³ food storage in kitchen?

All types of cupboards (walk-in pantries, Edinburgh Presses etc.) can be included in this assessment if they are shelved and have a door. Open shelving and undersink storage should be disregarded. Curtains should also be disregarded.

You are not expected to measure the kitchen storage but should use Diagram K18 to assist in your estimate.

This question deals solely with the minimum volume of kitchen storage present, not its condition or the suitability of its location, which are dealt with at K26.

Code 1: **YES**

Code 2: **NO**

Code 8: **NOT APPLICABLE**

No food storage in kitchen

Code 9: **UNOBTAINABLE**

K21. Is the kitchen working arrangement safe?

This question considers the whole kitchen working arrangement and its safety to the occupiers.

The working area immediately around the cooker is also assessed separately in K22. The cooker may be considered in relation to the sink.

You should consider the working area.

- can a person pass another easily or is the passageway/area too narrow/small to allow this?
- can people access storage/appliances safely?

You should assess the areas adjacent to the sink and particularly where the cooker is close by.

Working arrangements are also considered unsafe if:

- the sink and cooker are adjacent. To be considered safe there must be at least 300mm of worktop space between the cooker and sink wet area including drainers.

Code 1: YES – kitchen working arrangement is safe

Code 2: NO – kitchen working arrangement is unsafe

Code 8: NOT APPLICABLE

There is no kitchen storage and worktops or appliances present

Code 9: UNOBTAINABLE

1. K21 Examples



Yes

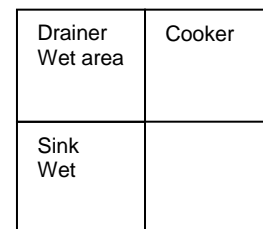

No

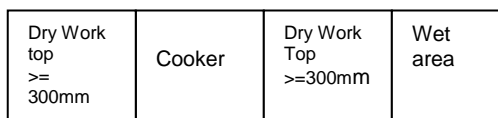

Yes

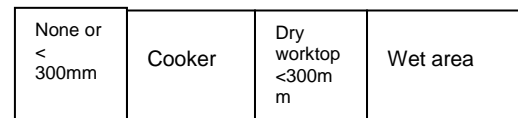

No

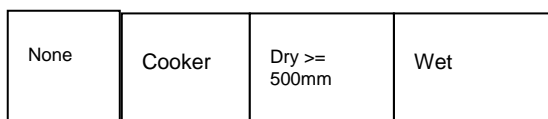

Yes

K22. Is the area around the cooker safe?

You should assess the area around the cooker and the arrangements for access to cooker. To be considered safe at least the following should apply:

- The cooker need not be present but a cooker space is obvious.
- Worktop space on at least one side of the cooker and at least the same width and depth as the cooker;
- Sufficient space to access the cooker;

- The handing of the cooker door should be such that you can gain easy access to the oven. Where there is a cooker space but no cooker you should assume that the handing will be safe;
- Standalone Aga type cookers can be considered area safe if they have some form of laying down space on the cooker equivalent to the width of the oven or 300mm on either side of the cooking area;
- Island cookers must have a minimum of 300mm worktop space on both sides or a worktop space at least the same width and depth as the cooker.

Code 1: YES – AREA AROUND THE COOKER IS SAFE

Code 2: NO – AREA AROUND THE COOKER IS UNSAFE

Code 8: NOT APPLICABLE

No area around the cooker

Code 9: UNOBTAINABLE

K23. Type of cooker?

You should determine the fuel use of the cooker before assessing the cooker type. If LPG gas is used where no mains gas then surveyors should add a note to this effect.

NOTE: Gas hobs and ovens should be classified as gas cookers. Similarly, electric hobs and electric ovens should be classified as electric cookers.

Code 1: GAS COOKER

Code 2: ELECTRIC COOKER

Code 3: GAS HOB, ELECTRIC OVEN

Code 4: KITCHEN RANGE, GAS

Code 5: KITCHEN RANGE, OIL

Code 6: KITCHEN RANGE, SOLID FUEL

Code 8: NO COOKER

Code 9: UNOBTAINABLE

K24. Sink

You should consider all parts of the sink including;

- the sink bowl/drainer; "3" Medium Repair
- one tap; "2" Minor Repair
- two (or more) taps "3" Medium Repair

- overflow and waste pipe; "2" Minor Repair
- plug and chain. "1" Small Repair

NOTE: The hot and cold supply to the sink is assessed separately and is recorded at K25.

Sink unit “carcasses” are not to be considered here, but are recorded at K26.

K25. Hot and cold to sink

You should consider both the hot and cold supply pipes to the sink but **not** the taps, which are recorded at K24.

NOTE: Provision must be available (though not necessarily in working order) of both hot and cold water supplies. The provision of only one (or no) supplies must be recorded as Code 8 (no amenity).

An instantaneous water heater/geyser is deemed to be acceptable for the purposes of this question but it must have **at least 7 litres capacity**.

K26. Kitchen storage and worktops

You should consider all parts of the existing kitchen storage and worktops including;

kitchen unit carcasses;	30% of unit cost;
doors/drawers;	30% of unit cost;
ironmongery	10% of unit cost;
work surfaces.	30% of unit cost.

Section L. Services and fittings

Section L records the services present and assesses the state of repair of any fittings present within the dwelling.

L1. What mains services does the dwelling have?

Code 1: ELECTRICITY ONLY

The dwelling has a supply of electricity from the public mains.

Whether or not the current occupants choose to use this supply is not important.

Any gas in the dwelling is provided by bottled gas or an LPG supply.

Code 2: ELECTRICITY AND GAS

The dwelling has mains supplies of both electricity and gas.

Whether or not the current occupants choose to use these supplies is not important.

Code 3: GAS ONLY

The dwelling has a mains supply of gas.

Whether or not the current occupants choose to use this supply is not important.

Any electricity in the dwelling is provided by a private generator/supply.

Code 8: NO SERVICES

The dwelling is not connected to a public mains supply of either electricity or gas.

Code 9: UNOBTAINABLE

You are unable to determine if the dwelling is connected to a mains supply of either electricity or gas.

NOTE: For the purposes of this survey the following are to be considered as mains supplies:

- small generators providing electricity to more than one dwelling;
- and bulk LPG storage tanks serving more than one dwelling

L2. Is a prepayment meter present?

Code 1: ELECTRICITY ONLY

Code 2: ELECTRICITY AND GAS

Code 3: GAS ONLY

Code 4: NO

The dwelling does not have any prepayment meters

Code 9: UNOBTAINABLE

You are unable to determine if the dwelling has a prepayment meter.

L2a. Is a Smart meter present?

Code 1: ELECTRICITY ONLY

Code 2: ELECTRICITY AND GAS

Code 3: GAS ONLY

Code 4: NO

The dwelling does not have any smart meters

Code 9: UNOBTAINABLE

You are unable to determine if the dwelling has a prepayment meter.

L3. Type of electric meter

Code 1: SINGLE

Code 2: DUAL

Code 3: 18 HOUR

Code 4: 24 HOUR

Code 8: NOT APPLICABLE

The dwelling does not have any form of electric meter

Code 9: UNOBTAINABLE

You are unable to determine if the dwelling has an electric meter.

L4. Does the dwelling have a privately generated power supply?

Code 1: NO

The dwelling does not have a privately generated power supply.

Code 2: YES, FUEL GENERATOR

The dwelling does have a privately generated power supply provided by a fuel generator (diesel etc/petrol) – must be permanent.

This may take the form of a privately owned, independent generator.

Code 3: YES, WIND GENERATOR

Code 4: YES, HYDRO - WATER WHEEL/ WATER TURBINE

Code 5: YES, OTHER – SURVEYOR NOTES

Photo voltaics within the curtilage of the dwelling will be recorded here but not those in the roof recorded at D7

Solar panels are not to be recorded here but at D7

Code 8: NOT APPLICABLE

The dwelling does not have any form of electric power supply.

Code 9: UNOBTAINABLE

You are unable to determine if the dwelling has a privately generated power supply.

L5. Is standard of the electrical power system satisfactory?

The current Building Standards require the following number of socket outlets for both private and public sector dwellings:

kitchen, minimum of 6 socket outlets;

each apartment, minimum of 4 socket outlets;

anywhere in dwelling an additional 4 socket outlets

.

Twin socket outlets are to be counted as two sockets in this assessment. Switched spur socket outlets are included in the count.

The source of the electricity supply (public or private) is not important here.

NOTE: You should assume that the power sockets in the dwelling are a true indicator of the power system in the dwelling ie. 13 amp socket outlets indicate the presence of a 13 amp system.

Where you encounter a power system within a dwelling that is part 13 amp and part 5 or 15 amp you should record the system as mixed, code 3.

You must therefore first consider whether or not the power system is wholly 13 amp. If the answer is yes you should assess the provision of socket outlets against the requirements specified above and record code 1 or 2. If the answer is no, you should record code 3 for mixed systems (where there is some 13 amp present) or code 4 for 5/15 amp systems (where there is no 13 amp present).

Code 1: INADEQUATE NUMBER OF SOCKETS

The dwelling has a 13 amp power system but **does not** satisfy the current requirements with regard to the provision of power sockets as outlined above.

Code 2: ADEQUATE NUMBER OF SOCKETS

The dwelling has a 13 amp power system and **does satisfy** the current requirements with regard to the provision of power sockets as outlined above.

Code 3: MIXED SYSTEM

The dwelling has a power system comprising some 13 amp and some other (specification not important) circuits.

The number of power sockets in the dwelling is not important with regard to this answer category.

Code 4: 5/15 AMP MIXED SYSTEM

The dwelling has a power system comprising some combination of 5 amp and 15 amp circuits.

Any power systems comprised solely of 5 amp or solely of 15 amp should also be recorded using Code 4.

The number of power sockets in the dwelling is not important with regard to this answer category.

Code 8: NO ELECTRICAL POWER SYSTEM

The dwelling does not have an electrical power system.

Code 9: UNOBTAINABLE

You are unable to determine if the electrical system within the dwelling is satisfactory.

NOTE: The condition of the electrical power system is not to be considered here but is recorded at L3 and L16.

L6. Are there power socket(s) in the conservatory?**FOR THE DEFINITION OF A CONSERVATORY REFER TO D6****Code 1: NO**

The conservatory does not have any 13 or 15 amp power sockets located within the conservatory.

Code 2: YES

There is one or more 13 /15 amp power socket(s) located within the conservatory.

Code 8: NO CONSERVATORY

The dwelling does not have a conservatory.

Code 9: UNOBTAINABLE

The dwelling has a conservatory but you are unable to ascertain if it contains any 13 or 15amp power sockets.

L7. Is the electrical power system dangerous?

This feeds into the new tolerable standard element on dangerous electrical systems.

Code 1: NO

The electrical power system **is not** dangerous.

NOTE: This will not be interpreted during survey analysis to mean that the power system is safe as it is recognised that it is easier to identify a dangerous system than it is to be sure that a system is safe - which requires specialist knowledge.

Code 2: YES

The electrical power system **is** dangerous.

A dangerous power system will be indicated by:

- broken casings and damaged power socket boxes;
- exposed wiring;
- other obvious signs of damage, disrepair or unauthorised alterations, especially to the consumer/meter units.

NOTE: The overloading of power sockets by the occupants of the dwelling is not to be considered. The adequacy of the provision of sockets relative to the current Building Standards is considered at L4.

If you are recording the power sockets as dangerous the extent of this should be recorded at L16 as disrepair.

Disrepair to the electrical power system which you **do not** consider to be dangerous is recorded at L16.

You must not advise occupants of your decision to record the electric power system as dangerous. Where a dangerous power system is found you should contact your Regional Manager as soon as possible.

Code 8: NO ELECTRICAL POWER SYSTEM

The dwelling does not have an electrical power system.

Code 9: UNOBTAINABLE

You are unable to determine if the electrical power system within the dwelling is dangerous.

L8. Is the standard of the electrical lighting system satisfactory?

This feeds into the new tolerable standard element on dangerous electrical systems.

Code 1: YES

The standard of the electrical lighting system **is** satisfactory.

This is taken to mean that the number and position of electrical light outlets within the dwelling is suitable for normal domestic purposes.

Code 2: NO

The standard of the electrical lighting system **is not** satisfactory.

This is taken to mean that either the number or the position of electrical light outlets within the dwelling is not suitable for normal domestic purposes.

Code 3: NO, DANGEROUS

The electrical lighting system within the dwelling is dangerous. This will be indicated by:

- damaged switch boxes;
- exposed wiring;
- light switches in the bathroom (pull cords are acceptable);
- other obvious signs of damage, disrepair or unauthorised alterations.

If you are recording the lighting as dangerous the extent this of should be recorded at L17 as disrepair.

Disrepair to the electrical lighting system, which you do **not** consider to be dangerous is recorded at L17.

You should not advise occupants of your decision to record the electric lighting system as dangerous. Where a dangerous lighting system is found you should contact your Regional Manager immediately.

Code 4: NO ELECTRICAL LIGHTING SYSTEM

The dwelling does not have an electrical lighting system.

Code 9: UNOBTAINABLE

You are unable to determine if the electrical lighting system within the dwelling is satisfactory.

L9. Is the underground water main (or communal rising main to the flat) lead free?

This question relates to the mains drinking water supply up to the incoming stopcock within the dwelling.

Any common storage and down services before the mains supply enters the dwelling is to be recorded at this question.

Code 1: YES

The mains water supply is lead free up to the stopcock inside the dwelling.

Code 2: NO

You have seen evidence of lead in the mains water supply up to the stopcock inside the dwelling.

Code 8: NO WATER MAIN

The dwelling is not connected to a mains water supply. Any supply of drinking water within the dwelling will therefore be from a private or non-mains source.

Do not include temporary disconnections in this definition.

Code 9: UNOBTAINABLE

You are unable to determine if the mains drinking water supply to the dwelling is free of lead up to the stopcock.

L10. Is the entire water distribution and storage system within the dwelling lead free?

You should attempt to examine the whole of the water supply system beyond the incoming stopcock including:

drinking water outlets (within dwelling and beyond incoming stopcock);

pipe work to drinking water outlets;

water storage tanks within the dwelling;

water storage tanks in the loft space (include any common storage tanks located in tank rooms or roof space that supply the selected dwelling. Do not include any water storage tanks already assessed at L8);

all other pipe work and fittings (cylinders etc.) to both the hot and cold water systems.

NOTE: Do not include physically separate central heating systems.

Code 1: YES

The whole of the water supply system beyond the incoming stopcock within the dwelling is free from lead.

Code 2: NO

Lead is present in the water supply system beyond the incoming stopcock.

The amount of lead present is not important with regard to this answer code.

Code 9: UNOBTAINABLE

You are unable to determine if the water supply system beyond the incoming stopcock within the dwelling is free of lead.

L11. Is there a private water supply to the dwelling?

Code 1: NO

The dwelling is supplied from Scottish Water

Code 2: YES

The dwelling has a private water supply.

Usually found in rural areas but occasionally found in some urban areas. The occupier will usually know if they have a private water supply as they will not pay water rates on their Council Tax Bill.

Large water (covered) cisterns may be visible in the environs of the dwelling.

Code 8: NO WATER MAIN

Code 9: UNOBTAINABLE

You are unable to determine if the water supply is from a private supply.

L12. Are there smoke detectors in the dwelling?

You are not required to determine if any smoke detectors are in working order.

You should note the presence of smoke detectors and record the total provision within the dwelling using the appropriate answer code.

The installation of mains powered smoke detectors in dwellings has been required under the building regulations since 1993.

NOTE: You should attempt to determine through inspection if smoke detectors are powered by batteries or by mains electricity. If this is not possible you may ask the occupant.

Code 1: 1 BATTERY POWERED

The dwelling contains 1 battery powered smoke detector

Code 2: MORE THAN 1 BATTERY POWERED

The dwelling contains more than 1 battery powered smoke detector

Code 3: 1 MAINS POWERED

The dwelling contains 1 mains powered smoke detectors. The dwelling does not contain any battery powered smoke detectors.

Code 4: MORE THAN 1 MAINS POWERED

The dwelling contains more than 1 mains powered smoke detector in the dwelling. The dwelling does not contain any battery powered smoke detectors.

Code 5: MORE THAN 1 MIXED

The dwelling contains at least 1 battery powered detector and at least 1 mains powered smoke detector.

Code 8: NO

The dwelling does not contain any smoke detectors

Code 9: UNOBTAINABLE

You are unable to assess if there are any smoke detectors in the dwelling.

L13. Do all external door(s) have adequate locks?

You are required to assess all entrance doors to the dwelling.

This question assesses the security of all external doors to the dwelling solely within the control of the dwelling occupants, i.e. ignore common close doors.

Only external doors leading directly into the dwelling should be assessed, garden gates and side gates should be ignored.

You should assess the adequacy of locks regardless of whether they are used by the occupants and/or their state of repair.

Entrance doors include:

Front, rear and side doors;

Patio doors;

French doors;

Doors leading directly into a garage;

Door leading directly into an outhouse from which there is external access;

Doors onto a balcony.

The requirements for adequate security are as follows:

Type of door	Requirements
Single doors	Mortice lock; Rim type deadlock; Key operated multi-point lock;
Double doors inc French Doors	Mortice lock with 2 key operated security bolts shooting into the frame, fitted top and bottom of each opening door; Rim type deadlock with 2 key operated security bolts shooting into the frame, fitted top and bottom of each opening door; Key operated multi-point lock.
Patio Doors	Key operated multi-point lock; One key operated patio door lock plus two key operated security bolts (fitted top and bottom of each opening door) shooting into either the frame or the door. (It is likely that the two key operated security bolts will have been retrospectively fitted); One key operated patio door lock plus an anti-lift device preventing the lifting of sliding patio doors from their frames.

For both mortise locks and rim type deadlocks the number of levers present should not be considered for this question.

Where a porch or conservatory is present in addition to a door leading directly into the dwelling you should assess both doors. So long as at least one of these doors has adequate locks then that entrance can be considered to be satisfactory.

Regarding 'thumb-turn' locks on the inside of above ground individual dwelling doors i.e. generally individual flatted properties above ground floor level. Guidance from other sources, most notably Secure by Design and the Scottish Fire Service recommend that thumb-turn locks are fitted to properties to make it easier for residents to exit their property without having to find the appropriate key in the event of an emergency. So far as SHS is concerned, we would recommend the following:

If a thumb-turn lock is already fitted in an above ground floor property, then we would judge that the locks are adequate so long as an appropriate letter box guard has been fitted or the letter box is set in the lower door rail to deal with the external entry security risk.

If a thumb-turn lock is not fitted in an above ground floor property and the locks comply in all other respect then the locks should be scored as adequate.

If a thumb-turn lock is already fitted in an above ground floor property but without an appropriate letter box location or guard, then surveyors should assess the locks as inadequate.

Code 1 YES

All external door(s) have adequate locks.

Code 2 NO

All external door(s) **do not** have adequate locks.

Code 9 UNOBTAINABLE

You are unable to establish if all external doors have adequate locks.

<p>L14. Door viewer and restrictor present on main entrance door?</p>

This question ascertains the presence of devices designed to ensure the safety of occupants from unwanted callers and intruders.

You should assess the main entrance door to the dwelling. This entrance will usually be at the front of the dwelling. Door bells and letterboxes are usually located at the main entrance door.

NOTE: Where a **porch is present in addition to an entrance door** you should assess the first door visitor would encounter according to the following rule: **If the porch door has a lock the porch door is assessed, otherwise the entrance door to the dwelling is assessed.**

Door viewers are:

Manufactured units installed within doors at eye level providing a magnified view of callers at the door

Clear glass panels within doors or at the side of doors allowing an occupant to ascertain the identity of the caller before opening the main door.

Opaque/translucent glazing is not suitable for ascertaining identify of callers.

The presence of curtains and blinds should be ignored when making this assessment.

Door restrictors are:

Manufactured units, generally a chain but can be of rigid metal, designed to allow only partial opening of the door by the occupant.

Code 1: NO

The dwelling does not have either a viewer or a restrictor present at the main entrance door.

Code 2: VIEWER ONLY

The dwelling has a viewer present at the main entrance door. There is no restrictor present.

Code 3: RESTRICTOR ONLY

The dwelling has a restrictor present on the main entrance door. There is no viewer.

Code 4: BOTH VIEWER AND RESTRICTOR

The dwelling has a viewer and a restrictor present at the main entrance door.

Code 9: UNOBTAINABLE

You cannot establish if a viewer or restrictor is present at the main entrance.

Note on L15 to L18

The services recorded by questions L15 – L18 must be located inside the dwelling otherwise use Code 8 (no amenity).

You should assess the extent of any disrepair to the services in questions L15 – L18 as a percentage of the total cost of that service.

You should record disrepair as a percentage of the cost as follows:

Code 0:	No repair	0%
Code 1:	Small repairs	up to 5%
Code 2:	Minor repairs	5% to less than 25%
Code 3:	Medium repairs	25% to less than 60%
Code 4	Renew	60% to 100%

L15. Cold water system

You should consider all parts of the cold water system in their assessment including:

- stop valve;
- drain cock;
- rising mains;
- cold water storage tank;
- cold water system primary distribution pipe work.

L16. HOT WATER SYSTEM

You should consider all parts of the hot water system in their assessment including:

- hot water tank;
- immersion;
- boiler, back boiler or cylinder which only serves the hot water system;
- flow and return and vent pipe work;
- multi-point;
- gas circulator.

L17. ELECTRICAL POWER SYSTEM

You should consider all parts of the electrical power system in their assessment including:

- power circuit;
- cooker circuit;
- power sockets;
- fuse boards/circuit breakers etc.

NOTE: Disrepair to night storage circuits and controls is recorded at M19 (Central Heating Source) and M20 (Central Heating Distribution).

You should record the following as disrepair:

- lead cable;
- TRS (Tough Rubber Sheathed) cable;
- sockets other than 13 amp.

L18. ELECTRICAL LIGHTING SYSTEM

You should consider all parts of the electrical lighting system in their assessment including:

- wiring;
- light switches;
- lighting outlets.

NOTE: You should record unprotected surface wiring as disrepair. Exposed wiring would be considered dangerous and in disrepair.

L19. Percentage fixed light fitted with low energy lighting (LEL) (Specify to nearest 10%)

The fixed lighting fixtures to be assessed are those assessed in the electrical lighting system considered in L8 and L18.

NOTE: Low energy lighting includes both fluorescent tubes and the various types of compact fluorescent light bulbs.

Do not assess lamps or moveable lighting of any type in this question.

Record the extent of low energy lighting is installed in the dwelling,

Specify: The percentage of fixed lighting fitted with low energy lighting (measured in the same way as the 10 point scale for disrepair as a proportion of count).

0% (no LEL present)	Score as 00
<15%	Score as 01
15% <25%	Score as 02
25% <35%	Score as 03
35% <45%	Score as 04
45% <55%	Score as 05
55% <65%	Score as 06
65% <75%	Score as 07
75% <85%	Score as 08
85% <95%	Score as 09
95% <100%	Score as 10

Code 88 NOT APPLICABLE

The dwelling does not have any lighting system.

Code 99 UNOBTAINABLE

You are unable to assess the presence of low energy lighting.

L20. Is there a mechanical ventilation system?

Mechanical Ventilation Systems use fans instead of natural driving forces to drive the ventilation process. By sealing the building, complete control can generally be achieved.

Approaches include:

Mechanical Extract: A fan is used to 'suck' air out of a space. A suction pressure is established which draws outdoor 'make up' air into the space through purpose provided openings and/or leakage gaps. Ideally the extract point is placed in proximity of indoor pollutant sources, e.g. extracting cooker/range hoods, fume cupboards etc.). It is possible to place a heat-pump in the extract air stream to recover heat.

Mechanical Supply: A fan is used to 'blow' air into a space. The resultant over pressure pushes air out of purpose provided openings and gaps in the building fabric. Since the air enters at a single location and the 'over-pressure' inhibits infiltration, the incoming air can be reliably filtered to remove any harmful outdoor pollutant. The supply air can also be preheated (or cooled) by placing 'heating' and 'cooling' coils in the air-stream. Heat recovery is not possible.

Mechanical Balanced Ventilation: Both mechanical supply and extract networks are incorporated into the space. Advantages include being able to filter the supply air and efficient 'air to air' heat recovery. Disadvantages include the extra cost of the twin network, combined with fan energy use. To work correctly, the building essentially needs to be completely sealed. Any gaps in the fabric will allow air infiltration to add directly to the design air change rate.

Recirculation: essentially a balanced system in which a proportion of the indoor air is re-circulated and blended with incoming outdoor air (perhaps up to 80% of the air is re-circulated). This is used when the ventilation system is also used to provide thermal conditioning to a space (i.e. through heating and cooling coils)

Mixing or Dilution Ventilation: This is essentially conventional natural and mechanical ventilation. The incoming air mixes (or is assumed to mix) uniformly with the air in a space thus 'diluting' indoor contaminants.

Displacement Ventilation: Mechanical supply diffusers are carefully designed to provide air at low velocity and within 2-3K above room temperature at floor level. The incoming air ponds in the space and pushes away rather than mixes with the existing room air. This can lead to much improved air quality in the breathing zone than can be achieved with mixing ventilation for the same ventilation rate.

Code 1: NO

Code 2: YES, MECHANICAL VENTILATION SYSTEM PRESENT

Code 3: YES, MECHANICAL VENTILATION SYSTEM WITH HEAT RECOVERY

Code 9: UNOBTAINABLE

L21. Number of extract fans? (valid values 0–9)

The number of extract fans in the dwelling is a straightforward count of the individual extract fans serving single rooms regardless of whether they were installed during the original construction, or retrofitted subsequently.

NOTE: The count of extract fans does not include vents or extracts that are part of 24-hour mechanical ventilation systems, or positive pressure systems (such as the Nuaire Flatmaster or Drimaster systems), or passive ventilations systems.

Specify: Number of extract fans [0-9]

Surveyors may need to refer back to question H8 for kitchen and bathroom to remind themselves of the possible presence of fans in these rooms

L22. Number of large vents (open chimneys) (valid values 0-9)

The number of large vents is a straightforward count of the open large vents (open chimneys) in the dwelling. Large vents (open chimneys) that are blocked up by temporary arrangements (e.g. such as hardboard) are still counted. Permanently blocked large vents (open chimneys) are not counted.

A large vent (open chimney) is defined as **an opening that extends to the top of a dwelling and has an internal area of more than 0.03m²**. This area equates to a circle with a diameter that is greater than 200 mm (i.e. greater than 8" in diameter). A vertical opening that is smaller than this should be counted as a small vent (see L22).

Also counted as a large vent (open chimney) are any air bricks in rooms that do not have a combustion appliance (i.e. open fire, solid fuel room heater, gas fire, gas, oil, LPG or solid fuel boiler, or gas oil or solid fuel cooker) and meets the measurement criteria of a large vent (i.e. an internal area of more than 0.03m²).

Specify: Number of large vents [0-9]**L23. Number of small vents (valid values 0-9)**

The number of small vents is a straightforward count of the number of small vents in the dwelling. Small vents that are blocked up by temporary arrangements are still counted. Permanently blocked small vents are not counted.

A small vent is defined as an **opening that extends to the top of a dwelling and has an internal area of less than or equal to 0.03m²**. This area equates to a circle with a diameter that is less than or equal to 200 mm (i.e. up to 8" in diameter).

The following are also counted as a small vent:

A small vent from an open flued appliance entering a large vent .

A large vent for a solid fuel appliance with flow control of the air supply.

A small vent liner sealed into the large vent

A large vent fitted with a damper.

A blocked up fireplace fitted with a ventilator.

Also counted as a small vent are any air bricks in rooms that do not have a combustion appliance (i.e. open fire, solid fuel room heater, gas fire, gas, oil, LPG or solid fuel boiler, or gas oil or solid fuel cooker) and meets the measurement criteria of a small vent (i.e. an internal area of less than or equal to 0.03m²).

Specify: Number of small vents [0-9]

Section M. Heating and Insulation

INTRODUCTION TO HEATING

The survey uses two standard approaches to define the energy efficiency of a dwelling - the National Home Energy Rating (NHER) and the Reduced Data Standard Assessment Procedure (RdSAP). Both have a common background - the Building Research Domestic Energy Model (BREDEM) - and share many of the same calculation algorithms and conventions. Despite their similarities there are also significant differences.

The NHER is a non-linear scale ranging from 0 (the worst) to 20 (the best), is based upon the total energy costs per square metre of floor area of the dwelling, taking account all fuel uses in the home and the local climate.

The RdSAP methodology was developed to produce Energy Performance Certificates that complied with EU legislation. The resultant A to G rating scale is based on the space and water heating and lighting costs per square metre of floor area of a dwelling using the average UK climate (i.e. the East Pennine region).

There are four key components to the SHS assessment of a dwelling's NHER and RdSAP ratings. These are:

the type of heating and hot water system within the dwelling;

the controls of the space and water heating

the age of the dwelling; and

the levels of insulation.

The NHER and RdSAP programs allows **the heating system or heating appliances** within the dwelling to be differentiated according to 'primary' and 'secondary' heating. It is possible that there may be more than two heating systems and/or appliances present within a dwelling. However, once the primary and secondary heating systems are identified, any other heating appliances are ignored for the purposes of the NHER and RdSAP assessment.

It is important to remember that both the NHER RdSAP assessments are concerned with the dwelling's characteristics, and not the occupants' use of the dwelling. Therefore, where the occupants are using portable forms of heating, these appliances **are to be COMPLETELY ignored**.

THE DWELLING IS TO BE ASSESSED ACCORDING TO THE HEATING THAT IS INSTALLED, AND NOT BY WHETHER OR NOT THE OCCUPANTS USE IT.

A household may ignore, or not use, the installed heating and rely on portable heating or upon the secondary heating. Situations that are not unusual are:

Where a partial or whole house electric storage heating system has been installed but the household has turned off all storage heaters and is using a fixed or portable direct acting heater in the lounge. In this situation, the storage

heating would be entered as the Primary Heating and the direct acting appliance IF FIXED is entered as the Secondary Heating. If it is a portable heater, it should be ignored.

Where a gas fired central heating system has been installed to provide the space and water heating, but the householder is relying on the gas fire in the lounge and using the back up electric immersion heater for the hot water. Here, the gas-fired central heating would be entered as the Primary Heating and the gas fire IF FIXED as the Secondary Heating.

If the gas fire is a portable fire, it should be ignored. The principal hot water heating source would be recorded at M16 as 'from the Primary Heating Boiler' (Code 01). The use of the electric immersion heater would be ignored.

M1. NHER age category

NOTE: Please ensure that the date that you select here is consistent with the “building warrant age” of the dwelling, which is very important for assigning the correct default U-values.

For houses, the ‘date of construction’ of the dwelling selected at C4 may differ (possibly by being one age band later than that selected at M1) as the dwelling may have applied for a warrant in the previous age band but not been completed until later (warrants typically have a 3-year life span, but can be extended further with permission).

If the dwelling is part of a conversion from a non-domestic building, then NHER age will be the “building warrant age” no matter when the original building was constructed.

Code 01: Pre-1919

Dwellings in this age band are usually assumed to have solid wall construction, either stone or brick. Stone walls tend to be characterised by a thickness of 500mm or more. Solid brick walls tend to be distinguishable from brick cavity walls by the brick pattern, as header bricks (i.e. the ends of the brick, as opposed to the length of the brick which are known as stretcher) should be seen in the brick pattern in the main wall construction. Solid brick walls in houses were often less than 250mm thick, but in lower storeys of the tenements the walls were often another half brick thick to support the weight of the upper floors, so would be about 350mm thick.

Windows were originally traditional single glazed wooden sash, and sash and case, windows. Often there will be large angled bay windows.

Ceiling heights in rooms on lower storey often in excess of 3m with cornices, some ceiling roses and moulded skirting boards.

Originally, the main form of heating will have been via open fires so there are still likely lots of chimney pots on the roof (even if they are no longer used).

Predominantly, dwellings constructed by the private sector. Very little public sector housing built before 1919.

Code 02: 1919 – 1929

From 1919, and for the next 50 years, the public sector becomes increasingly the predominant builder of housing in Scotland. The result of this involvement effects many aspects of house design. The influence of the 'Garden Town' movement is reflected in the emergence of low rise estates, with many local authority 4-in-a-block type flats and semi-detached dwellings built during this period with large room sizes and generous storage. Ceiling heights reduce to 2.6-2.7m.

Stone was used less and less as a building material for the main walls. Where stone was used, the wall thicknesses were reduced to between 300-450mm. Early forms of concrete block were introduced during this period.

This age band includes both solid brick constructions, but increasingly from the late 1920's onwards, solid brick walls were replaced by cavity wall constructions to overcome problems of water penetration through the wall. The wall thickness of the brick wall increases to about between 280 to 300mm with the introduction of the 50 to 70 mm clear cavity. Header bricks disappear from the brick pattern as the bricks are all laid in stretcher. Render wall finishes predominate with facing brick limited to architectural features. The introduction of cavity walls in the UK tends to be north to south, and west to east geographically (starting in the north, with London about the last area and maybe not till the 1940s).

Some steel frame and steel panel clad non-trad house types date from the period immediately after World War I as ways of generating work for the shipyards.

Code 03: 1930 - 1949

The 1930's, up to World War II, very much dominated by public sector cavity-walled, low rise estates. Ceiling heights at 2.5-2.6m were still generous compared to today, but less so compared to earlier periods.

Private sector houses characterized by bungalows and 1 and a half storey bungalows with off-street car parking provision being beyond the traditional urban centres.

Concrete blocks were common feature of tenement construction. Rendered wall finishes predominate.

Casement windows became more common. Steel window frames emerge from the mid-1930's onwards.

You may still find ‘Anderson Shelters’ in the back gardens of estates built in this period. Immediately after WWII, there was very little building initially.

Code 04: 1950 - 1964

House building, once it started after WWII, is characterized by many non-traditional forms of construction – no fines concrete and imported timber kit houses – as public sector tries to keep the cost of construction down. There are few architectural enhancements and room sizes were reduced for reasons of cost and shortage of materials. Ceiling heights at 2.4m become the norm. Many of the designs are similar initially to pre-WWII houses.

As the nation emerges from rationing, several policy developments shape a large amount of Scottish housing construction – the new greenfield estates built on the the peripheries of the urban centres (Easterhouse, Drumchapel, Pollock/Nitshall and Castlemilk in Glasgow, Westerhales in Ednburgh, Fintry and Whitfield in Dundee, Ferguslie Park in Paisley, and Maastricht in Aberdeen all started construction in the mid to late 1950s. These were complemented by starting construction of the new towns – East Kilbride and Glenrothes established in 1948 and Irvine, Cumbernauld and Livingston in the early 1960s.

The first true high-rise (i.e. 8 stories or more) was built in 1958 at Moss Heights in Glasgow, and followed very quickly by many more around the country.

Metal framed windows become the norm.

One important event during this period was the publishing of the Parker Morris Committee report in 1961 entitled Housing for Today and Tomorrow, which summarised the needs of housing to be ‘space and heating’. The report recommended “that the minimum standard should be an installation capable of heating the kitchen and areas used for circulation to 55°F [approximately 13°C] and the living areas to 65°F [approximately 18°C] when the outside temperature was 30°F [approximately -1°C].” This was the first attempt to include a minimum temperature in the design of dwellings, and became mandatory in local authority dwellings. It was only discontinued in the early 1980s. While this temperature standard was also intended for the private sector, it was never brought into effect. The effect of what became known as the Parker Morris standards was the beginning of installing partial house heating systems in local authority dwellings – particularly, solid fuel back boilers feeding several radiators – so chimneys were still prevalent. Where gas was used it would have been town gas at the time. Electric heating began to emerge as well.

Some flat roofed dwellings were built around the early 1960s.

Driveways and garages start to be built in the 1960s, but commonly on public housing estates of this period was communal parking areas away from the front of the dwellings.

Dwellings on estates are likely to have only one or two dwelling types. Most roads will be 'access roads' to other parts of the estate and there will be few cul-de-sacs. Traffic calming measures will not have been included with the estate when it was originally built. The layout of new towns were pedestrian friendly separating cars from people.

Code 05: 1965 - 1975

A major change was the first insulation standards as part of the first national Scottish Building Regulations that came into effect in June 1964. These insulation standards required dwellings to meet a U-value for heat loss through the roof of $1.1 \text{ W/m}^2\text{C}$ and a U-value for heat loss through the external walls of $1.7 \text{ W/m}^2\text{C}$. While most wall constructions of the time met the 1.7 standard, to meet the roof U-value required the insulation of 1-inch (25mm) of loft insulation. This loft insulation is likely to have been improved since.

Dwellings were built with their own fenced front and rear gardens. Estates often comprised only one or two dwelling types. Reasonably large rooms and windows.

Wall finishes are generally rendered with facing brick reserved for architectural details on the front elevation. Other than bay windows there are few architectural enhancements. Chimneys were built until the end of the 60s when central heating replaced coal fires.

Code 06: 1976 – 1983

As a direct reaction to the fuel shortages and steep price rises of the early 1970s, the government increased the insulation standards in the Scottish Building Regulations in 1975. These insulation standards required dwellings to meet a U-value for heat loss through the roof of $0.6 \text{ W/m}^2\text{C}$ (equivalent to 50mm of loft insulation, that is, twice as much as before) and a U-value for heat loss through the external walls of $1.0 \text{ W/m}^2\text{C}$. Post 1978 it became quite common to install 75-80 mm of loft insulation as a result of government grants and investment programmes. many dwellings will have been upgraded by their owners. The wall U-value standard could be met by using lightweight aerated concrete blocks on the inner leaf of the wall construction. Glazing was limited to the extent that the weighted average of the U-value for the wall and the glass was no greater than $1.8 \text{ W/m}^2\text{C}$. Majority of the dwellings are of masonry cavity construction with thermolite blocks for the inner leaf resulting in walls 310-330mm thick. Rendered wall finishes predominate.

The predominant builder during this period was the private sector. The direct effect was a reduction in space standards, a lowering of ceiling heights (coming down to 2.3m or less), and the increasing density of estates. Private builders were building dwellings to make money: low densities and higher standards reduce profit margins.

Gas central heating began to emerge as the dominant form of heating in the private sector. Gas central heating meant that gas flue terminals replaced chimneys.

Code 07: 1984 - 1991

The effects of continuing rising oil prices and further concerns about the security of foreign supplies led to another increase in the insulation standards in the Scottish Building Regulations in 1982. These insulation standards required dwellings to meet a U-value for heat loss through the roof of $0.35 \text{ W/m}^2\text{C}$ (equivalent to 100mm of loft insulation, that is, twice as much as before) and a U-value for heat loss through the external walls of $0.6 \text{ W/m}^2\text{C}$. For the first time walls needed some insulation to be included within them (e.g. 25 mm of insulation in the cavity) to comply with the standard. Some dwellings were built with a clear cavity as before, but by using insulation underneath the internal plasterboard to ensure compliance. The effect of both part cavity and internal insulation approaches is to increase the wall thickness of a cavity wall to about 330mm.

The major transformation in dwelling construction is the emergence of the 'modern timber frame' (a.k.a. timber frame kit) house. Here, the internal leaf was replaced by a timber frame construction (e.g. 90 to 100 mm studs) with mineral fibre insulation placed between the studs, with plywood on the cavity side and plasterboard on the internal side closing off the structure. From accounting for only a small % of dwellings before 1982 (timber frame dwellings built in the 1960's and 70s usually had a wall thickness of less than 150mm) the industry estimates that over 60% of all dwellings built in Scotland since 1982 are modern timber frame dwellings. Compared with 330mm thick masonry walls from this period, the thickness of timber frame walls are often no more than about 280mm thick.

Glazing was still predominantly single glazing as there was no U-value standard for the windows to meet. However, the area of glazing was restricted to 15% of the external wall area.

Chimneys begin to reappear – not because of the return of solid fuel, but because of the use of gas flame effect of fires as focal point fires. Gas heating was the overwhelming dominant form of central heating where there was a choice. The gas boilers at this time would be predominantly wall hung with balance flues.

No requirement for mechanical extract fans in bathrooms and kitchens that are naturally ventilated.

Code 08: 1992 - 1998

The Scottish Building Regulations were revised again in 1991. The new insulation standards required dwellings to meet a U-value for heat loss through the roof of $0.25 \text{ W/m}^2\text{C}$ (equivalent to 150mm of loft insulation

at the time) and a U-value for heat loss through the external walls of $0.45 \text{ W/m}^{20}\text{C}$. For the first time floors required insulation as the heat loss through the ground floor was limited to $0.45 \text{ W/m}^{20}\text{C}$.

With timber frame constructions the studs increased to 100 mm with mineral fibre insulation between the studs.

One visual change as a result of a revision of the ventilation requirements in the Regulations was that all bathrooms, kitchens and similar wet rooms were to be fitted with an extract fan. Previously, extract fans only needed to be fitted where there was no opening window.

While the amount of glazing allowed was revised to being no more than 15% of the total floor area (as opposed to total wall area in previous regulations), there was still no U-value standard. However, double-glazing (if only sealed units with only a 6-mm gap) became the de facto standard as the public expected new dwellings to have double-glazing.

Code 09: 1999 – 2002

The only explicit change in the 1997 regulations was the requirement for windows to be at least double-glazed. The insulation standards requirements for the roof (i.e. $0.25 \text{ W/m}^{20}\text{C}$), the external walls (i.e. $0.45 \text{ W/m}^{20}\text{C}$), and the floor (i.e. $0.45 \text{ W/m}^{20}\text{C}$) remained unchanged. However, what did change was the way these U-values were calculated, as now minor bridging elements had to be taken into account in the calculations. The effect was to increase the amounts of insulation needed in the wall, roof and floor elements. For example, whereas 150 mm of loft insulation was deemed to comply with the 0.25 standard after 1991, the thickness needed to increase to 170mm to comply once the cold bridging effect was taken into account as a result of the 1997 Regulations.

Mechanical extract units in all bathrooms and the kitchen.

Code 10: 2003-2007

The majority of these dwellings will be timber framed, however, they have noticeably higher insulation standards. In 2002, the insulation standards were again increased to require dwellings to meet a U-value for heat loss through:

- the roof of $0.16 \text{ W/m}^{20}\text{C}$ (equivalent to 270mm of loft insulation);
- the external walls of $0.30 \text{ W/m}^{20}\text{C}$ (timber studs effectively increased to 145 to 150 mm thick so that the total wall thickness of the wall increases to about 320mm thick);
- the ground floor of $0.25 \text{ W/m}^{20}\text{C}$;
- the openings of $2.2 \text{ W/m}^{20}\text{C}$ (if no more than 25% of floor area), effectively, low-emissivity glazing became compulsory though this requirement was delayed by a year to 2003 – look for a date stamp in the gap between the panes of glass;

Mechanical extract units in all bathrooms and the kitchen.

Code 11: 2008-2011

In 2007, some of the insulation standards were again increased to require dwellings to meet more onerous requirements, however, the changes are not necessarily readily obvious to a visual survey. However, two changes may be more obvious:

- first, where a gas or oil boiler is fitted, condensing boilers of at least 86% seasonal efficiency effectively became mandatory
- second, all new houses applying for a Building Warrant after May 2007 are required to have an Energy Performance Certificate (EPC) affixed to the dwelling on completion. The Regulations suggested fixing the EPC inside the meter cupboard – so that is one place to look for it.

Code 12: 2012 onwards

With the 2011 revision to Section 6: Energy, the insulation standards were revised in several ways, so that looking for specific insulation thicknesses became more difficult. Rather than a specific U-value standard for the walls, roofs, floors, and glazing, an “area weighted maximum average U-value” was introduced so that designers would have more flexibility in their designs to trade off insulation in one part of the dwelling with another. The area weighted average U-value standards were:

- the roof of 0.18 W/m²°C (equivalent to 250mm of loft insulation);
- the external walls of 0.25 W/m²°C;
- the ground floor of 0.20 W/m²°C;
- the openings of 1.8 W/m²°C (if no more than 25% of floor area).

The minimum seasonal efficiency of gas boilers was increased to 90% (when calculated as previously, which became known as the SEDBUK 2005 method). This was compounded because of the changes in SAP 2009 which introduced a new method for testing boiler efficiencies. Under this new method, i.e. SEDBUK 2009 method, the minimum boiler efficiency was set at 88%. Minimum boiler and other heating system efficiencies were introduced for a wide range of other heating types as well.

The carbon dioxide emissions standard approach was retained, i.e. the DER for the dwelling had to be equal to or lower than the TER, but the basis of the TER calculation was made more onerous. If a dwelling only just complied with the backstop insulation standards and minimum boiler efficiency, then it would not likely comply overall with the regulations. A straightforward approach to obtaining compliance was include renewable technologies ((referred to as low or zero carbon technologies within the building design, e.g. photovoltaic (PV) panels, solar hot water, or heat pumps).

A possible cross reference here is to search the Scottish Assessors Association website (www.saa.gov.uk) for the Council Tax band by post code – this gives the date when properties were first registered on the Council Tax register (very useful for identifying dwellings ages for those built after April 1, 1993)

M1 Summary Table re: Building Ages, common construction and insulation factors

Age	Wall Construction and Insulation	Roof Insulation	Floor insulation	Glazing	Ventilation	Comment
pre 1919	Solid stone 600mm. Solid Brick 230mm	None	None	Wood single sash	None	high ceiling heights >3m often
1919-29	1919 - homes fit for heroes- beginning of low rise estates / 4-in-a-block / Solid stone 450mm. Solid Brick 230mm	None	None	Wood single sash	None	ceiling heights 2.7 and falling
1930-49	Stone cavity brick 400-450mm. Brick cavity 300-330mm , concrete cavity 300-400 some non-trads	None	None	Wood single/ metal single begins	None	ceiling heights 2.6 - 2.5
1950-64	Cavity Brick 300>330mm many non-trads / swedish and weir timber / no fines concrete - first true high rises	None	None	Wood single/ Metal single	None	ceiling heights 2.4 parker morris standards: partial central heating
1965-75	Cavity Brick 300>330mm: all walls to be 1.7 w/m2K or better many high rises	first insulation required: 25mm. Possibly Vermiculite	None	Wood single/ Metal single	None	ceiling heights 2.4 - 2.3 1st national Building regs
1976-83	Cavity with lightweight blocks 300-330 private builders	50mm	None	Wood single/ Metal single	None	1975 Building regs

1984-91	Cavity with insulation in cavity 300>330mm. Cavity with insulation on internal face 300>330mm. Modern Timber frames 280mm	100mm	None	Wood single/ Metal single	None	ceiling heights 2.35 1982 Building regs
1992-98	Timber frames 270>280mm. Cavity with insulation in cavity 330mm. Cavity with insulation on internal face 330mm.	150mm	25-50mm	Wood single/ Metal single but usually Double installed because of market demand	At least 2 Extract fans	1991 Building regs
1999-2002	Timber frames. 270>280mm cavity with insulation in cavity. Cavity with insulation on internal face.	150mm	50mm	Double	At least 2 Extract fans	1997 Building regs
2003-2007	Timber frames - 300+ / insulation in 330 cavity. Cavity with insulation on internal face 330mm.	270mm	100mm EPS	Double with low E. Date may be stamped in window	At least 2 Extract fans	2002 Building regs
2008-2011	Timber frames - 300+ / insulation in 330 cavity. Cavity with insulation on internal face 330mm. more dense insulation materials used	270mm	100mm phenolic boards	from 2003 onwards Double with low E. Date may be stamped in window	At least 2 Extract fans	2007 Building regs - condensing gas, oil or LPG boiler - EPC (look in meter cupboard)
2012+	Timber frames - 300+ / insulation in 330 cavity. Cavity with insulation on internal face 330mm. more dense insulation materials used	300mm	100mm+ phenolic boards	high performance DG windows with low-e glass / argon filled insulated spacers: U-values 1.4 or triple glazing	At least 2 Extract fans	To comply with the Section 6 Energy Building Regulation standards after 2010 dwellings are likely to require renewable technologies (e.g. heat pumps, PV panels or solar hot water systems) as part of the design (not retrofitted)

1976-1983	1984-1991	1992-2002	
			Detached
			Semi-Detached
			Terrace
			Tenement
			4-in-block type
			Tower/slab
			Flat in converted building
1975-1982	1983-1990	1991-1997	

M2. What is the main form of the heating in the dwelling?

The survey form allows for **two heating systems plus room heaters** within the dwelling to be identified, differentiated according to the 'main heating' system, a second heating system, and other room heaters.

The '**main**' form of heating (Main Heating 1) in a dwelling is intended to be the primary or main form of heating installed in the dwelling that provides the heating to most rooms (and usually the hot water as well), or if no system is present, then the type of heating appliances that provide heating to most rooms. **Room heaters cannot be the main heating unless the dwelling is only heated by room heaters**, then the main type of heating will be the room heater that provides heating to the main living room of the dwelling. So where there is a choice between a system and room heaters found within the dwelling, the system is the main heating identified in M2 and room heaters are identified in M22.

THE DWELLING IS TO BE ASSESSED ACCORDING TO THE HEATING THAT IS INSTALLED, AND NOT BY WHETHER OR NOT THE OCCUPANTS USE IT. PORTABLE HEATING IS IGNORED COMPLETELY!!!

Conventions for Identifying the Main Heating System

Where you are faced with a choice between two or more types of heating in a dwelling follow the conventions below to identify the 'main' heating:

1. Where there is a choice between a system (regardless of whether it is a 'boiler' system, community heating, a 'warm air' system, 'storage heating' or a heat pump system) and a type(s) of room heater, always select the **system** as the main heating.

NOTE: Electric storage heaters are considered a type of 'system', even when there is only one storage heater in the dwelling. Therefore, if the choice is between storage heaters and other types of room heater (whether they be electric heaters of any sort, open fires, or gas fires) the electric storage heater is to be identified as the main heating)

Electric storage heating provide drift heat and background heating to rooms in the dwelling over and above the rooms they are actually installed in. It is possible therefore for the rooms with electric storage heaters to be numerically outnumbered by the rooms with direct-acting room heaters. The electric storage heaters are still intended to be the main heating and scored accordingly.

2. Where there is a choice between two heating systems, you will usually select the heating system that heats the living room as the main heating in M2, and select Option 2 (i.e. Yes) in M21a to indicate there is a second system, and then describe it in the Surveyor notes. The exceptions to this convention are dwellings with 2 systems, and one of them is either community heating, heat pump system, or a micro-CHP system, in those situations the community heating, heat pump system, or a micro-CHP system

are always the main form of heating, and the other system identified through M21a and the surveyor notes.

3. Where the choice is between two systems and they both provide heat directly to the living room, or they serve the same distribution network, select the one with the lowest running costs as the main form of heating (i.e. fuel price / heater efficiency, so usually gas over oil over solid fuel over electricity).

4. If there are ONLY fixed room heaters (i.e. No system at all) in the dwelling, then select the type of room heater that heats the lounge as the main heating, and enter the other room heater through M22.

5. If there is still any doubt, select the appliance that heats the lounge.

NOTE: Where there is **NO FIXED HEATING** in any room in the dwelling, enter primary heating as 'ROOM HEATERS' (code 4 at M2) and the fuel as 'PEAK ELECTRIC' (code 11 at M5). In H9, all surveyed rooms will also have been scored as Yes, Socket (i.e. Code 3).

Code 1: BOILER

This code includes **ALL** individual dwelling boilers regardless of their fuel type and regardless of the type of boiler. This code includes:

- all gas, LPG, oil, solid fuel, and electric boilers. The fuel firing the boiler is identified separately at M5.
- standard, system, conventional, regular combi or range cooker boilers; wall or floor mounted boilers; open, balanced, or fan assisted flued boilers; thermal store or CPSU boilers; all condensing boilers; and back boiler systems providing space heating. Boiler characteristics are identified in more detail in M6 to M8.

NOTE: “Boiler” implies heat distribution within the home via hot water through radiators or underfloor pipework. If the heating system does not distribute heat via hot water then it is one of the other types of heating below.

NOTE: If the boiler heats more than 1 dwelling, then it is considered to be a ‘community heating’ system – see Code 2 below).

Code 2: COMMUNITY HEATING

Community heating (also known as group heating, district heating, and combined heat and power) provides heat to more than one dwelling from a centralized boiler plant.

Common examples of where community heating is likely to be included are sheltered housing schemes owned by housing associations or the local council. The extent of the community heating scheme may be only a few dwellings. It may extend over hundreds of dwellings.

Code 3: STORAGE HEATING

This code includes all forms of storage heating, both modern, slimline, and older block storage heating radiators regardless of the tariff they are charged under by the electricity utility. It also includes electric underfloor heating systems where the pipes or cables are buried in the floor screed and electric ceiling heating where the cables are buried in the ceilings.

Storage heaters will usually be part of a "central heating" system, as there will be some form of centralised control (e.g. a time clock or a teleswitch) for controlling when the storage heaters can be charged, regardless of whether or not there is any separate control present on the individual heater).

Occasionally electric storage heaters may be classified as "room heaters" where no such central control exists, or where they are plugged into a normal electrical sockets.

NOTE: The scoring of the storage heater here must be consistent with the information recorded at H9 (Has room satisfactory provision for heating? Code 1: central heating or Code 2: room heater).

Code 4: ROOM HEATER

This code should be used when there is no central heating system in the dwelling, and the primary form heating is provided by an individual fixed heating appliance, or combination of appliances. **REMEMBER: PORTABLE HEATERS ARE TO BE IGNORED COMPLETELY.**

See Code 7 below for Solid Fuel Back Boilers that heat hot water only (i.e. they are not connected to a radiator system).

Code 5: WARM AIR SYSTEM

Use this code for any ducted warm air system from a centralised heat source. Warm air systems distribute heat through grilles in the wall or floor. There are no radiators in warm air systems.

Code 6: HEAT PUMP

A heat pump is a device that absorbs heat energy from a low temperature source and upgrades it to a higher temperature so that the heat can be usefully used for space or water heating purpose. There are a number of heat pump techniques by which this upgrading can be achieved.

The low temperature source may be one of three types:

- ground source, using a series of closed pipe loops either buried horizontally in shallow trenches or vertically in boreholes in the ground;
- water source using series of closed pipe loops submerged in water, such as a river, a lake, a pond or a well;

- air source, in effect, the reverse, the reverse of an air-conditioning unit, absorbing heat from the outside air and transferring that heat into the house.

The useful heat may be delivered to the household by either a water-based (i.e. radiators or underfloor pipework) or an air-based system. So, ground-to-water, water-to-water, air-to-water, ground-to-air, water-to-air and air-to-air systems are all possible types of heat pumps.

NOTE: The fuel for most heat pumps will be electricity. For air-to-water and air-to-air heat pump systems the fuel may be either peak electric or off peak electric.

NOTE: Some heat pump systems are designed to be used in conjunction with a secondary room heater.

Code 7: HEAT PUMP WITH MCS CERTIFICATE

The Micro-Cogeneration Scheme (MCS) was introduced to promote quality assured installations of heat pumps by registered installers. To be eligible for some of the grants and feed-in-tariffs the heat pump must be installed by a MCS registered installer, and the MCS certificate left with the householder. If the dwelling is heated by a heat pump, The MCS certificate may be on display in the meter cupboard. Otherwise ask the householder if they have a MCS certificate. If an MCS certificate cannot be confirmed, use Code 6.

Code 8: ROOM HEATER (Back Boiler: NO RADS)

Where there are solid fuel fires with back boilers (regardless of whether they are open or closed fires) used for heating **ONLY the hot water** (i.e. there are no radiators), they are to be recorded here with the primary form of heating recorded as Code 7 at M2 (i.e. 'Room Heaters – BB no rads'), then Code 8 at M7 (i.e. not applicable) and then the appropriate code (i.e. code 1 or code 2) for the type of back boiler at M15.

By contrast, a dwelling with a solid fuel back boiler connected to radiators, the back boiler should be recorded as Code 1 at M2 (i.e. primary form of heating is a 'Boiler' system and the type of boiler recorded as Code 5 at M7 (i.e. backboiler) and then the Code 1 or Code 2 for the type of back boiler at M15.

M3. Heat emitters

This question assesses the method by which the heating is actually delivered (emitted) within the dwelling.

NOTE: This question is now concerned with ALL types of heating and not just wet central heating heat emitters.

Code 1: RADIATORS

The dwelling is heated via radiators. This option could apply to the heat emitters for a 'Boiler' (code 1 at M2), for 'Community heating' (code 2 at M2) and for a some heat pumps (code 6 at M2)

The most common types are wall-mounted steel panels. Cast iron radiators are less common but are still made. Chrome towel rails and designer radiators (for example, tubular steel designs) are also included in this category.

Code 2: APPLIANCE

The heat is being emitted by the appliance or the heater directly, and not distributed through the dwelling through another delivery method.

This option would apply to 'storage heating' (code 3 at M2), 'room heaters' (code 4 at M2), some 'heat pumps' (code 6 at M2) and 'room heater (bb no rads)' (code 7 at M2).

Code 3: UNDER FLOOR

This option could apply for both a wet central heating system and for a storage heater system – just that the method of delivering the heat is very different.

For wet central heating systems, underfloor pipework replaces the radiators. Warmed water is circulated in pipes embedded in the floor, and the heat passed from the water into the floor. Wet underfloor systems have become increasingly more common over the last couple of years. There are likely to be individual room thermostats in every room.

For storage heating, cables are embedded in the floor, which warm up and pass heat into the floor. These systems were at their most common in the late 1960s early 1970s, particularly in concrete multi-storey blocks of flats. Most have long been obsolete and been replaced with another form of heating, though you may still see remnant of the system at the consumer unit of a dwelling.

NOTE: Where there are both underfloor pipework and radiators (not an uncommon arrangement in a 2-storey dwelling) code the heat emitters as Code 1: Radiators (which is the RdSAP convention).

Electric under floor heating should be scored as partial CH in every case. The original concept was for the living room, part of the kitchen and bathroom and hall to be heated. The bedrooms were not normally heated or some but not all may have had panel heaters installed. The two storey house with full electric under floor heating on the ground floor would also be scored as partial even if the upper floor had all panel heaters. We don't consider the drift heat sufficient to cover for a full system.

On the other hand: Wet under floor heating systems should normally be considered as full unless there is evidence to the contrary. The chances

are that this type of system has been installed in a very energy efficient shell and thus likely to be categorised as full.

Code 4: CEILING

Similar in design to electric underfloor storage heating, except that the cables are embedded in the ceiling. These warm up and pass heat into the room below. These systems were at their most common in the late 1960s early 1970s. Again, most have long been obsolete and been replaced with another form of heating in the dwelling.

Code 5: OTHER – SPECIFY IN SURVEYOR NOTES

A warm air system would come under this category, whereby the heat is distributed by passing warmed air through ducting in the dwelling.

Code 8: N/A

M4. Extent of central heating system

Code 1: FULL

The whole dwelling, or rooms representing more than 50% of the floor area of dwelling, is heated from the main heating system or where there are two systems, the combined extent of their heating provision.

NOTE: Independent heaters in all rooms do not constitute central heating, and therefore would Code 8 under this question.

Code 2: PARTIAL

Partial central heating usually comprises the ground floor of houses with two or more levels, or up to 50% of the floor area for flats.

Code 8: NO CENTRAL HEATING

The dwelling has no central heating system.

NOTE: Back boilers used solely for domestic hot water are not a form of central heating and should be recorded with this code. Generally, such systems have no radiators attached to the system or only one in the hall.

Code 9: UNOBTAINABLE

You have been unable to obtain access to at least half of the habitable rooms in the dwelling.

NOTE: When you are unable to gain access to all of the rooms in a dwelling, you may extrapolate your findings from a partial internal inspection up to a whole dwelling level if you have been able to gain access to at least half of the habitable rooms.

M5. Main heating fuel

Most of the main heating systems and appliances recorded at M2 can be fuelled by more than one fuel. The NHER program allows for 15 different fuel types from which to select for the main heating, and the possibility of 'dual fuel'

Where an appliance can be fed with different fuel types, you should record the first appropriate fuel type from the following sequence:

GAS -> OIL -> COAL -> ELECTRICITY.

Code 01: GAS (MAINS)

Supplied by a gas supplier via connection to the national gas grid.

Code 02: BULK LPG (Liquefied Petroleum Gas)

A large storage tank will be located outside the dwelling and within site of the driveway. Delivery will be via a large LPG tanker supplied by such companies as Calor Gas or MacGas, usually in the remoter areas of Scotland outwith connection to the national gas grid. This LPG will usually be used to fuel a central heating system within the dwelling.

Code 03: BOTTLED GAS

Usually known as 'Calor Gas' or 'Flo Gas' or 'MacGas'.

This option usually refers to the larger stand alone cylinders (45 to 55kg) that may be located outside the dwelling for a fixed heating system. Where there is more than one cylinder present they are often linked together via a regulator valve.

Occasionally, the smaller sized LPG cylinders (i.e. 11 to 15 kg) cylinders may be used in the same way and would also be considered 'bottle gas' under this option. Additionally, they may be found providing fuel to individual fixed room heaters, and would again be considered under the primary and secondary heating conventions.

However, the small cylinders are more usually associated with use in small portable heaters (and are therefore would be ignored by the surveyor).

Code 04: OIL

While the heating system within the house may look very similar to that of other boiler systems, oil boilers need an oil supply so there will be a large metal or plastic storage tank for the oil. This may be outside the dwelling, or may be in a cellar or basement.

Code 05: HOUSE COAL**Code 06: SMOKELESS****Code 07: ANTHRACITE**

Code 08: WOOD CHIPS

Code 09: WOOD LOGS

Code 10: WOOD PELLETS

These relate to various grades and types of solid fuel supplied to the household. The two most common types of solid fuel are 'House Coal' and 'Smokeless Coal'. House coal is cheaper of the two and may be supplied and purchased in areas that are not designated smokeless zones.

Anthracite nuts and grains are usually smaller sized, more expensive, higher grades of solid fuel that are used in solid fuel boilers with automatic feed systems.

Wood boilers, especially those fuelled with wood pellets, are becoming increasingly more common.

NOTE: Within a known designated smokeless area, the presumption should be that the solid fuel being used is 'smokeless' (ie code 6).

NOTE: Where it is obvious that the household is using both a mineral solid fuel (i.e. some form of coal) AND some form of wood fuel, and the dwelling is not in a designated smokeless zone, then this situation can be accommodated by using Dual Fuel (Code 16 below).

Code 11: PEAK ELECTRIC

Indicated by a single electric meter with only one set of dials or digits. This is usually the tariff where there are only direct acting electric heaters (such as electric bar fires, fan heaters, or panel heaters) in the dwelling.

Code 12: OFF PEAK ELECTRIC

The split between the high and low rate tariffs are evidenced by two or more separate meters being present; one meter with at least two sets of digits or dials, or more commonly now the newer digital display meters, the meter will display more than one rate being present.

This option should be selected for ALL off peak electric heating systems (whether an electric storage heating or electric boiler system) where there is an off-peak supply. Examples are the Standard Economy or Total Heating Total Control or Economy 10 as provided by Scottish Hydro or any of the White Meter, Comfort Plus, or Economy 2000 tariffs as provided by Scottish Power, or Economy 7 and other off peak tariffs provided by other electricity suppliers operating in Scotland.

This option also includes the older 'so called' preserved electricity tariffs, which are a legacy of the old underfloor electric heating systems or the old fashioned, very large block storage heaters. They were phased out

in the early 1970's. They are only likely to be found in multi storey blocks of flats. Scottish Power defines/describes these as 'Off Peak Tariff C' or 'Off Peak Tariff D' tariffs on the fuel bill. In the Scottish Hydro refers to them as Tariff A, Tariff B, Tariff C, and Tariff D.

Code 13: COMMUNITY HEATING WITH NO CHP

Code 14: COMMUNITY HEATING WITH CHP

CHP stands for 'Combined Heat and Power'. A CHP scheme produces both heat AND electricity.

Most community heating schemes provide only space and water heating (e.g. via a group heating or district heating boiler plant) so will be recorded as Code 13 here (i.e. Community Heating with NO CHP).

The Lerwick District Heating (Shetland Heat and Power) scheme burns domestic and commercial waste as a fuel to heat water that is pumped through the houses. It does not generate electricity so would be Code 13 here.

Alternatively, if the unit also produces electricity along with the heat, then it will be recorded as Code 14 here (i.e. Community Heating with CHP).

NOTE: Where there is a community heating scheme (Code 2 at M2), whether it produces electricity or not, the fuel is to be recorded here as either Code 13 or Code 14, regardless of whether the fuel is gas, oil, solid fuel, or anything else. Most sheltered housing schemes with group heating in Scotland are fuelled via gas. **THE ACTUAL FUEL OF THE COMMUNITY HEATING PLANT IS TO BE RECORDED IN THE SURVEYOR'S NOTES!**

Code 15: BIOGAS (Landfill)

Biogas is methane, and its use is likely to be very rare in individual dwellings, but may be found in rural areas where the farms have installed methane digesters because of the abundant source of raw material to produce methane.

Code 16: DUAL FUEL

This code provides an alternative to a single solid fuel being recorded under Codes 5 to 10 above where it is obvious that the household is using both a mineral solid fuel (i.e. coal) AND wood.

Code 16: OTHER

Use this code for any other main heating fuel used and record the type of fuel in the surveyor notes on page 12 of the manual.

Code 88: NOT APPLICABLE

Use this code if none of the above options apply. This will be very rare.

Code 99: UNOBTAINABLE

This code should be used if you are unable to gain access to the heating to determine the Primary Heating fuel.

M6. Main heating system (MHS) age

The main heating system (MHS) age applies to **ALL** main forms of heating system identified in M2 with the exception of Code 4 - Room Heaters (as they are not a system!).

As a result of the EU Boiler Efficiency Directive that came into effect in 1998, the efficiency of ALL gas, LPG and oil boilers were improved significantly. Historically, there was a considerable fall off in boiler efficiency as the heat load reduced, so that a 65-70% efficient boiler at full load might be operating no better than 20-30% at part load. One of the requirements of Boiler Efficiency Directive for boilers sold within the EU was that boiler efficiencies were to be within 3% of their full load efficiency when operating at 30% part-load. Meeting this requirement resulted in many changes to boiler design (more responsive heat exchangers, less water contained within the boiler, the use of fan flues, getting rid of permanent pilot lights) with the effect of raising the overall efficiency of boilers.

Before the 1998, the previous significant date in gas boiler development in the UK was 1979, when the then state-owned British Gas raised the minimum boiler efficiency to be achieved from 60 to 65% if a boiler was to be approved for connection to the UK gas network. As with the 1998 Boiler Efficiency Directive, this 1979 change also had a considerable impact on boiler design. Before 1979 most domestic gas boilers were usually very heavy, often made of cast-iron, and therefore usually floor-mounted – they not only had a lower efficiency but a poorer responsiveness than later boilers. After 1979, boilers became lighter in weight, started to be mounted on walls, and the open flue arrangements began to be replaced by balanced flues.

Where there is some doubt, for old boilers it may be possible to calculate the original combustion efficiency for the boiler from the information included on the boiler plate:

$$\frac{\text{boiler output (likely to be in BTUs)}}{\text{boiler input (likely to be in BTUs)}} \times 100$$

If the resultant answer is less than 65%, then enter Code 3: Old.

A similar evolution has occurred with oil boilers, but rather than 1979, the change date was 1985.

Old fashioned, electric block storage heaters should be recorded as 'Old' as the pre-date 1979. For modern slimline electric storage heaters, the MHS Age will have no effect on their efficiency performance or on the rating of the dwelling.

Warm air systems can be aged as if they are gas boilers.

Code 1: 1998+

The mains gas, LPG or oil boiler was installed in 1998 or later.

Code 2: PRE 1998

The mains gas, LPG or oil boiler was installed before 1998, but installed before the respective date below so as not to be classified as old.

Code 3: OLD SYSTEM

For mains gas and LPG boilers, 'Old' refers to boilers installed up to 1979. For oil boilers, 'Old' refers to those installed up to 1985.

Code 4: OTHER – SURVEYOR NOTES

There should not be any occasion to use this option.

Code 8 : NOT APPLICABLE

This option applies if there is no system present (that is, either no fixed heating at all, or only fixed room heaters in the dwelling).

NOTE: If there is more than one boiler in the dwelling, select the age of the boiler selected as the primary heating system.

M7. MHS boiler type

If the main heating system is a boiler, record the type of **boiler** type here. This includes **ALL** types of boiler, including mains gas, LPG, oil, solid fuel and electric boilers.

Code 1: STANDARD

This option covers all boilers except combi, condensing and back boilers. A standard boiler (also referred to as a conventional boiler, a regular boiler, or a system boiler) has an indirect hot water cylinder attached to the system.

Code 2: COMBI BOILER

Combination boilers provide both space heating and instantaneous hot water within the same unit and therefore do not need a hot water storage cylinder to be present. Gas combi boilers are usually wall hung, but there are 1998+ (Code 1 at M6) and pre 1998 (Code 2 at M6) models that are floor standing (e.g. Worcester's High Flow and Heat Slave ranges). Combi boilers can often be concealed behind kitchen cupboard doors.

Combi boilers can be identified by:

- the lack of a hot water cylinder in the dwelling (do ensure it is not in the loft space);
- a presence of two thermostats on the boiler, one for the heating system and one for the hot water, located behind an opening panel on the front of the boiler;
- the presence of 5 or 6 pipes connected to the boiler (i.e. more than normal – fuel, primary flow for space heating, primary return for space heating, cold water feed and hot water supply).

NOTE: The presence of a pressure gauge is not an indication of a combi boiler but of a sealed system. There are sealed conventional boilers as well as sealed combi boiler systems.

The real test is, with the boiler is turned on, to turn on the hot water tap and see if the boiler fires. It will turn off when the tap is turned off (though not always immediately as some boilers have an overrun). If so, turn the hot tap on again to see if the boiler fires again. If this is the case then it is a combi boiler.

NOTE: **Condensing combi boilers, therefore there will also be a plastic pipe running out of the bottom of the boiler, are coded separately – see Code 4 below.**

NOTE: **Where there are solar panels, there is one possible situation where there may be a hot water cylinder present, where the water heated by the solar panels is stored and used to supply the combi boiler. The combi boiler only needs to provide the additional heat needed to raise the solar-heated water up to the required hot water temperature.**

Code 3: CONDENSING BOILER

Condensing boilers are now the norm. Since May 2007, condensing boilers are required (where practicable) by the Building Regulations to be installed in new dwellings, and where boiler replacements are undertaken in existing homes. Condensing boilers are characterised by a plastic drain pipe (usually either 19mm or 32mm diameter) running from the bottom of the boiler to a suitable external drain.

A condensing boiler is the only type of boiler with such a plastic drainpipe.

NOTE: **Use this code for condensing boilers that ALSO have a hot water cylinder. If the condensing boiler is also a combi boiler then it is a condensing combi and should be recorded as Code 4 below.**

Code 4: CONDENSING COMBI BOILER

A combi boiler that is ALSO a condensing boiler (see code 2 above). All of the tests for a combi boiler (see code 4) will apply, but there will also be a plastic pipe running out of the bottom of the boiler.

Code 5: BACK BOILER

This option covers ALL back boilers, regardless of age. The back boiler will usually be built into the chimney breast and located behind a gas or solid fuel fire or heater. The gas fire in front of the back boiler will be

designed with grilles to allow for additional ventilation to reach the back boiler

As this option is part of a central heating system there **MUST** be radiators attached to the back boiler.

NOTE: With a back boiler it is **NOW** necessary to enter the gas fire in front of the back boiler as a secondary heating system.

NOTE: In October 2009, Baxi introduced the first condensing back boiler unit. The presumption is that more will follow. These boilers should be recorded as Code 5 - back boiler, and then state that it is a condensing back boiler in the Surveyor Notes. Hopefully, this will also be confirmed via the boiler manufacturer and model number at M10a and M10b below.

Code 6: CPSU

A Combined Primary Storage Unit (CPSU) is a single appliance designed to provide both space heating and the production of domestic hot water, in which there is a burner that heats an integral thermal store (that is, within the boiler casing, as opposed to standing separately outside the boiler casing) which contains mainly primary water which is in common with the space heating circuit. The thermal store must have a capacity of at least 70 litres in size and the feed to the space heating must be taken directly from the thermal store.

NOTE: If the unit does not contain an integral thermal store within the boiler unit with a capacity of at least 70 litres, or the space heating is not taken from the thermal store, then the unit is to be recorded as a Code 2 - combi

NOTE: If the thermal store is independent from the boiler unit, regardless of its capacity, then it is to be recorded as a Code 1 – standard boiler and the thermal store recorded as if it was a hot water cylinder at M29 to M32 below.

Code 7: RANGE COOKER

Range cooker boilers are flued cooking appliances predominantly of cast iron construction that are designed to provide space heating or space and hot water as well. Under this option there must be a radiator system attached to the range cooker boiler. If there are no radiators connected to the range then it is not a boiler.

Code 8: NOT APPLICABLE

The dwelling does not use a boiler-fired central heating system as the main form of heating (that is, anything other than Code 1 in M2)

NOTE: If there is more than one boiler in the dwelling, select the boiler type for the boiler selected as the primary heating system.

M8. MHS boiler flue type

If the main heating system is a boiler, record the type of **boiler** flue here. This includes **ALL** types of boiler, including mains gas, LPG, oil, solid fuel and electric boilers.

The type of flue attached to the boiler has a direct impact on the boiler's efficiency – fan assisted flue boilers are more efficient than balanced flue boilers, which in turn are more efficient than open flue boilers.

Open flues act like a narrow chimney, commonly have a diameter of 125 to 200mm, and rising vertically from the boiler through the ceiling / roof with a minimum of bends. Open flued boilers draw air directly from the room for combustion purposes then vent the combustion y-products to the outside via the flue. Open flues were the predominant (if not the only) type of flue up to 1979, but considerably less common since.

The replacement for open flue was the balanced flue. Rather than rising vertically, it vented the waste gases horizontally directly through the external wall. Importantly, they do not pull air into the boiler directly from the room, but from the outside through a separate channel within the flue, thus the description as being a 'room sealed flue'. They rely on natural convection to pull the air into the boiler, so need to be sufficiently large to ensure that the boiler is not starved of oxygen. Thus, their size is a tell tale feature – often being 220 to 300 mm in diameter or of a similar size but rectangular or square in shape. Balanced flues were the predominant form of flue in the 1980s.

Fan-assisted flues are also a form of room sealed flue, but as the name implies, use a fan within the flue to force air from outside the dwelling into the boiler, improving the boiler combustion efficiency of the process. As with balanced flues, they have a separate channel for venting the exhaust gases to the outside. The big difference when compared to balanced flues is that they are considerably smaller in size, often being no more than 100mm in diameter. Boilers are almost exclusively fan-flued now. While they tend to be fitted horizontally through the wall, there are fan-assisted vertical flues where the boiler has been sited within the house but not on an outside wall.

The introduction of condensing boilers reduced significantly the temperature of the flue gases leaving the boiler, but did not remove all of the heat from the exhaust gases. Flue Gas Heat Recovery Systems (FGHRS) are designed to capture this residual heat within waste flue gases resulting from the combustion of gas in the boiler. This recovered heat is used to preheat the cold water entering the boiler, thereby lowering the amount of energy needed to warm the water up to the required level, and further improve the boiler efficiency. As these devices are connected to the boiler flue as it leaves the boiler, they tend to look like another box sitting on top of the boiler,

Code 1: FAN ASSISTED

The boiler has a fan assisted flue.

Code 2: BALANCED FLUE

The boiler has a balanced flue.

Code 3: OPEN FLUE

The boiler has an open flue.

Code 4: FGHR

The boiler has a Flue Gas Heat Recovery System.

Code 8: NOT APPLICABLE

The dwelling does not use a boiler-fired central heating system as the primary form of heating. This would also apply where the boiler was an electric boiler.

NOTE: If there is more than one boiler in the dwelling, select the flue for the boiler selected as the primary heating system.

M9. Is MHS boiler in heated space?

If the main heating system is a boiler, record the location of the boiler.

Most mains gas and LPG boilers are sited inside the habitable dwelling, but they may also be sited in a basement, garage or other out building that is outside the habitable dwelling. Oil boilers have historically been sited outside the habitable dwelling (in an out building or even a special boiler case) because of the aroma given off from burning oil. However, with improvements in oil burner technology more and more are being sited within the habitable dwelling now.

Code 1: YES

The boiler **IS** sited within the habitable part of the dwelling.

Code 2: NO

The boiler is **NOT** sited within the habitable part of the dwelling.

Code 8: NOT APPLICABLE

The dwelling does not use a boiler-fired central heating system as the primary form of heating.

NOTE: If there is more than one boiler in the dwelling, select the location for the boiler selected as the primary heating system.

M10. Boiler manufacturer, model and model number

This question also includes for identifying Heat pump systems.

The direct result of the independent testing of boiler efficiencies brought into effect by the 1998 EU Boiler Efficiency Directive has been the development of a database of domestic boilers containing the specific seasonal efficiencies for the boilers within the database, which are invariably higher than the default efficiencies for the generic boiler

types. Using the seasonal efficiency for a specific boiler that is higher than the default efficiency will result in a higher rating for the dwelling. The manufacturer, model and model number can also be used to confirm the boiler's type, age, and flue arrangements.

To identify the specific boiler we need THREE things – the name of the manufacturer, the name of the model, and the number of the model. As a manufacturer will usually make more than one boiler, and make more than one variation of a boiler model, ALL three elements may be crucial to identifying the specific boiler and its specific efficiency. See over the page for examples.

The Manufacturer's name is usually obvious, and on the out casing of the boiler. The model and model numbers may be less obvious. These can usually be seen on the front of the boiler, or underneath it. Sometimes they are listed behind a pull down flap. They may be on the boiler documentation or log book near the boiler. In social-rented housing, they may be written on the service sheet left with the tenant when the annual service check was carried out.

M10a BOILER MANUFACTURER

Note the boiler manufacturer

M10b MODEL and MODEL NUMBER / ID

Note the model and model number – It is IMPORTANT to include any letters.

NOTE: The surveyor is NOT to open up the boiler casing, or pull parts off the boiler, in the attempt to identify the manufacturer, model or number. The surveyor may look behind a pull down flap intended for such a purpose.

NOTE: Where a heat pump system is found. record the details here as well.

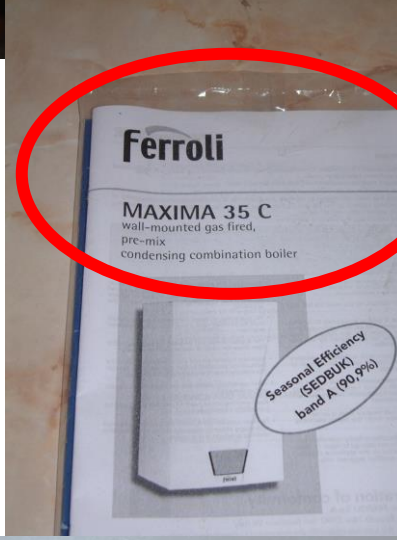
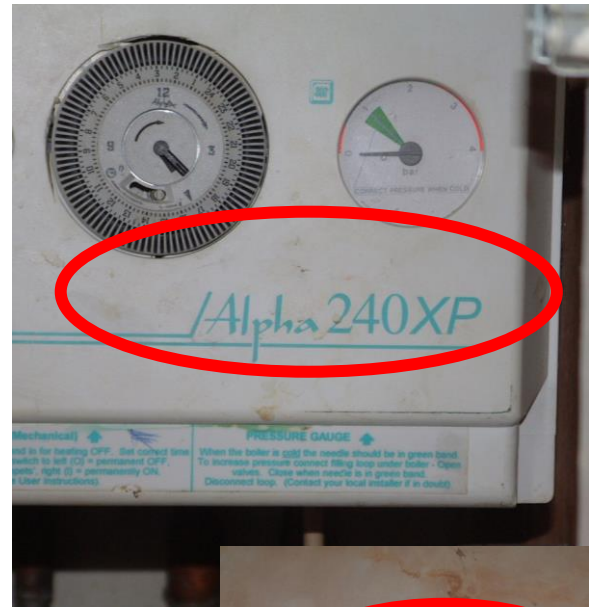

M11. Heat pumps

Heat pumps are referred to first by the source of the heat (i.e. ground, air or water) and then by the method for distributing the heat within the dwelling (i.e. water via radiators or underfloor pipework, or air), thus a 'ground to air heat pump' would use a series pipes located in the ground to collect the heat, and then transfer that heat to inside the dwelling where it would be released into the air via a heat exchanger unit directly into the room or via a ducting to be circulated through the dwelling. The two most common types of heat pump installed to date in UK dwellings are air to water heat pumps and ground to water heat pumps.

Code 0: GROUND TO WATER

The system uses a series pipes located horizontally or vertically in the ground to collect the heat, and then transfers the heat to a radiator system or underfloor pipework inside the dwelling. There is NO auxiliary (i.e. back up direct acting electric heater) in the dwelling.

Code 1: GROUND TO WATER / AUX HEATER

The system uses a series pipes located horizontally or vertically in the ground to collect the heat, and then transfers the heat to a radiator system or underfloor pipework inside the dwelling. There IS also an auxiliary (i.e. back up direct acting electric heater) in the dwelling.

Code 2: WATER TO WATER

The system uses a series pipes located in a river, lake or pond to collect the heat, and then transfers the heat to a radiator system or underfloor pipework inside the dwelling.

Code 3: AIR TO WATER

The system uses a unit that looks like an air-conditioning unit outside the dwelling to collect the heat from the air, and then transfers the heat to a radiator system or underfloor pipework inside the dwelling. The unit may be fixed to the wall of the dwelling; it may stand alone on the ground, but in both cases there will be pipes running from the unit into the house.

Code 4: GROUND TO AIR

The system uses a series pipes located horizontally or vertically in the ground to collect the heat, and then transfers the heat to inside the dwelling where it would be released into the air via a heat exchanger unit directly into the room or via a ducting to be circulated through the dwelling. There is NO auxiliary (i.e. back up direct acting electric heater) in the dwelling.

Code 5: GROUND TO AIR / AUX HEAT

The system uses a series pipes located horizontally or vertically in the ground to collect the heat, and then transfers the heat to inside the dwelling where it would be released into the air via a heat exchanger unit. There IS also an auxiliary (i.e. back up direct acting electric heater) in the dwelling.

Code 6: WATER TO AIR

The system uses a series pipes located in a river, lake or pond to collect the heat, and then transfers the heat to inside the dwelling where it would be released into the air via a heat exchanger unit directly into the room or via a ducting to be circulated through the dwelling.

Code 7: AIR TO AIR

The system uses a unit that looks like an air-conditioning unit outside the dwelling to collect the heat from the air, and then transfers the heat to inside the dwelling where it would be released into the air via a heat exchanger unit directly into the room or via a ducting to be circulated through the dwelling. The unit may be fixed to the wall of the dwelling; it may stand alone on the ground, but in both cases there will be pipes running from the unit into the house.

Code 8: NOT APPLICABLE

The dwelling does not use a heat pump system as the primary form of heating.

M12. Warm air system

Warm air systems distribute heat through grilles in the wall or floor. There are no radiators in warm air systems; instead they deliver heat throughout the house by blowing warm air through ducting. The heater units are generally taller and narrower than boilers, often occupying a cupboard within the central area of the dwelling. While less common now than they were in the late 1960s / early 1970s, warm air systems are still being installed, with improvements in the technology (e.g. flue gas recovery and condensing warm air units) to increase their overall efficiency.

Code 1: DUCTED ON/OFF

These ducting in these warm air systems extend out to the perimeters of the rooms, so that there vents in the floor or skirting board, or just above the skirting board, around at the external edges of the dwelling's perimeter. The older units (up to the mid-1970s) tended to be fully on or fully off.

Code 2: STUB DUCTED ON/OFF

In these warm air systems the ducting from these heater only extends to the rooms adjacent to the warm air unit (the name reflecting the short length of the ducting). The older units (up to the mid-1970s tended to be fully on or fully off.

Code 3: MODULATING

Modulating warm air units were introduced in the UK in the 1970s. These systems vary the fuel input to the heater as the demand changes and are more efficient than those that are simply all on / all off. It is likely that all warm air units installed over the last 20 years are modulating. With modulating units, the distinction between ducted and stub ducted does not matter.

Code 4: FLUE RECOVERY

Flue recovery warm air units are designed to recover some of the heat from the flue gases and pass it back to the heater. There will be a heat recovery unit attached to the warm air unit's flue. As this process uses a 'dry' heat exchanger in the flue to capture the heat, there is no need for a condensate pipe.

Code 5: CONDENSING

As with condensing boilers, condensing warm air units recover some of the heat from the flue gases through condensing the heat out of the flue gases and pass the back to the heater. Just as in condensing boilers, condensing warm air units will have a plastic pipe to drain the condensate.

Code 6: ELECTRICAIRES SYSTEM

'Electricaire' warm air units are the 'off-peak' electric versions of warm air units, and very similar in design to storage heaters in that they heat bricks up over night and passed air over the bricks during the day time. Rather than heat only one room, they ducted heat to more than one room in the dwelling. There will be an off-peak electricity meter arrangement to go with 'electricaire' warm air systems (thus their fuel will be recorded as code 12 at M5).

NOTE: Although an 'electricaire' warm air system may no longer be functioning or used in the house, the actual warm air unit may still be present in a cupboard. Some social landlords may have not removed the actual units because of the possibility of asbestos in the system, and the associated cost of removal.

NOTE: If there is an electric warm air system and no off peak electricity supply, then it should be coded here as code 1 (ducted) or code 2 (stub ducted) depending on the arrangement of the ducting, and the primary heating fuel recorded as code 11 (peak electric) at M5).

Code 8: NOT APPLICABLE

The dwelling does not have a warm air heating system as the primary form of heating.

NOTE: In principle, water-to-air, ground-to-air, and air-to-air heat pumps could be coded as 'warm air systems'. However, there are separate codes for heat pump units with regard to the primary heating system (at M2) and the type of heat pump (at M 11) that are to be used. These heat pumps are NOT to be coded here under M12 as a warm air system.

M13. Electric boiler system

Electric wet central heating systems began appearing in the mid to late 1980s as a response to criticism of electric storage heating. With electric boiler systems, the boiler heats the water in the system using either standard or off-peak electricity and that water is circulated through a network of radiators (or possibly underfloor pipework) as with other wet central heating systems. Early versions of these systems (i.e. the water storage and dry core boiler systems) were attempts to mimic electric storage heaters (i.e. by charging up the heat store over night). Since about 2004, the design has moved more to 'direct' heating and taking advantage of the variable charging tariffs that are available.

Code 1: DIRECT ENTRY

'Direct' acting electric boilers (also known as electric flow boilers) heat the water directly as it passes through the boiler unit (which is usually comprised of several heating elements similar to electric immersion heater elements). The units do not have any bricks or large stores of water therefore they are usually quite compact in size. Whether the direct acting electric boiler is supplied on the standard peak electric tariff or on an off peak tariff will be recorded at the primary heating fuel, i.e. either code 11 (peak electric) or code 12 (off peak electric) at M5.

Code 2: STORAGE

Electric water 'storage' boilers store up heat during off peak charging periods in a large volume of water (usually 170 litres or more) and then the stored heat is circulated through the radiator or underfloor pipework system. The radiator or underfloor pipework system will be connected to this hot water store. There is no separate electric boiler unit. The heating system will be on an off peak tariff, i.e. the primary heating fuel will be recorded as code 12 (off peak electric) at M5.

Code 3: DRY CORE

Similar in principle to the electric water 'storage' boilers but rather than store the heat in water, they use high density bricks (akin to electric storage heaters). When the dwelling requires heat, a fan blows heat over this dry core of bricks (thus, the name) onto a air-to-water heat exchanger, with the resultant heated water being circulated through the radiator or underfloor pipework system. The heating system will be on

an off peak tariff, i.e. the primary heating fuel will be recorded as code 12 (off peak electric) at M5.

Code 8: NOT APPLICABLE

The dwelling does not have an electric boiler heating system as the primary form of heating.

M14. Gas room heaters

A gas fire should only be coded in this section when Code 4 (Room Heaters) has been selected as the primary heating source at M2 **AND** the primary heating fuel has been recorded as Code 1 (Gas (Mains)), Code 2 (Bulk LPG), or Code 3 (Bottled Gas) has been selected as the primary heating fuel at M5.

NOTE: Where a Gas Room Heater is identified only as the secondary form of heating (see M22), then record Code 8 (Not applicable) here.

Code 1: GAS FIRE

This category includes for all gas fires unless they fall into one of the categories set out below. They provide heat via radiant heat output (from the flame and the removable white elements) and convected heat output (via the convector openings at the top of the heater), and are usually sited in front of a chimney breast, with the original chimney sealed off by a blanking plate, except for a small opening for the gas fire flue of the to fit into.

Code 2: COAL EFFECT FIRE, FLUED

This 'live fuel effect' (also known as 'coal effect' or 'flame effect') gas fire is sited within the fireplace. It usually has a fake coal basket, fake coal, and burns with an open flame. Importantly, the chimney opening has been reduced to a flue size (that is, less than 0.03m², less than 8 inches (200mm) in diameter) by the inset unit or a throat restrictor improves the efficiency of this type of fire. It will not necessarily be obvious from just looking at the front of the fire to tell if the chimney opening has been reduced.

Code 3: DECORATIVE

This decorative, 'live fuel effect' (also known as 'coal effect' or 'flame effect') gas fire is sited within the fireplace. This type of fire is designed to look like a real coal fire and has been very popular for the last 10 years. It usually has a fake coal basket, fake coal, and burns with an open flame. Importantly, the chimney opening has NOT been reduced. The opening will be 8 inches (200mm) or more in diameter. As a result, this type of gas fire has a very low efficiency. Gas is burnt in an 'open

grate' at the bottom of the hearth with waste combustion products passing up the chimney. The gas controls are often located behind or below the 'ash box' but can be located at the side of the fireplace. The gas supply pipe may be visible, but is often hidden.

Code 4: BALANCED

These fires are located on external walls with no chimney breast and flued directly through wall at the back. Balance flue terminal seen on outside of the external wall. Common models are VALOR Unigas, VALOR Homeflame, VALOR Nevada, BAXI Brazilia and ROBINSON WILLEY Bantam.

Code 5: CLOSED

Glass or close fronted fires have higher efficiency than open fronted fires. Fan assistance will further improve the fire efficiency. The 'close fronted' description refers to the fact that the fuel bed is room sealed by a glass-like panel (that is, it does not pull air for combustion from the room, but receives it from the fan assistance). If there are any gaps around the glass front then the fire is not room sealed.

Code 6: FLUELESS

Flueless gas appliances have been around for much of the past decade and incorporate a catalytic converter which the combustion gases pass through, converting them into carbon dioxide and water vapour. They look like LCD TV's. These fires do not require a flue, and therefore do not need to be sited on an external wall. While proclaimed in the trade press as 100% efficient, the default mains gas efficiency is 90% - the most efficient type of gas fire. These fires are becoming very popular.

Code 7: CONDENSING

'Condensing' gas fires return heat from the flue gases to the room, by condensing the heat out of the flue gases. Like condensing boilers, the tell-tale feature is the presence of a plastic pipe leading from appliance to an outside wall. These fires are very rare.

Code 8: NOT APPLICABLE

The dwelling does not use gas fired room heaters as the primary form of heating.

M15. Solid fuel room heaters/boilers

This section is used when either Code 2 (boiler) at M2 OR a Code 4 (room heater) has been recorded as the primary source of heating at M2, AND one of the solid fuels (House coal, Smokeless Fuel, Anthracite, or Wood chips, pellets or logs, or dual mineral and wood fuel, i.e. Codes 5, 6, 7, 8, 9, 10 or 16) have been selected as the primary heating fuel at M5.

While traditional solid fuel (i.e. coal-fired) systems are decreasing as they are replaced by other types of heating within dwellings, wood-fired solid fuel heating is on an

increase, particularly wood pellet-fired boiler systems, and wood burning stoves as a secondary heating appliance in new dwellings.

NOTE: Where a Solid Fuel Fire is identified only as the secondary form of heating (see M22), then Code 8 (Not applicable) should be selected here.

Code 1: OPEN FIRE

Fireplace with a chimney breast and grate. This option includes both where the open fire includes a back boiler unit with attached radiators (i.e. a boiler system) (and you will have recorded Code 5 (back boiler) at M7, AND where the open fire does not have a back boiler but is still the primary heating (and you will have recorded Code 8 (Not applicable) at M7).

NOTE: Ensure that the solid fuel open fire is not really a 'coal effect' gas fire. What looks like coal may be actually ceramic replica that does not burn. With such fake 'coal effect' fires there will be controls for the gas fire and maybe a visible gas pipe.

Code 2: CLOSED FIRE

The solid fuel is burned within an enclosed appliance with a door at the front and a flue. The heater may be located within the fireplace or elsewhere in the room. This option includes both where the closed fire includes a back boiler unit with attached radiators (i.e. a boiler system) (and you will have recorded Code 5 (back boiler) at M7, AND where the closed fire does not have a back boiler but is still the primary heating (and you will have recorded Code 8 (Not applicable) at M7).

Code 3: RANGE COOKER (NO OVEN)

These systems are based on solid fuel kitchen ranges. The important distinction is that the range incorporates a boiler unit for circulating hot water to radiators or underfloor pipework, and / or the hot water cylinder. In this option, the range can cook on the top of the range, but has NO oven unit.

NOTE: If the range cooker provides hot water for the space heating or for space heating and hot water it is a boiler (you will have recorded Code 1 (boiler) at M2 for the primary heating system AND Code 7 (range cooker) for the primary heating system type at M7.

If the range cooker provides ONLY hot water for the domestic hot water then it is a room heater (record Code 4 (room heater) at M2 if it is the primary heating system AND Code 8 (not applicable) for the primary heating system type at M7.

If the range cooker does not provides hot water for either space

heating or domestic hot water then it is to be ignored completely.

Code 4: RANGE COOKER (WITH OVEN)

These systems are based on solid fuel kitchen ranges. The important distinction is that the range incorporates a boiler unit for circulating hot water to radiators or underfloor pipework, and / or the hot water cylinder. In this option, the range can cook on the top of the range AND an oven unit.

NOTE: If the range cooker provides hot water for the space heating or for space heating and hot water it is a boiler (you will have recorded Code 1 (boiler) at M2 for the primary heating system AND Code 7 (range cooker) for the primary heating system type at M7.

If the range cooker provides ONLY hot water for the domestic hot water then it is a room heater (record Code 4 (room heater) at M2 if it is the primary heating system AND Code 8 (not applicable) for the primary heating system type at M7.

If the range cooker does not provides hot water for either space heating or domestic hot water then it is to be ignored completely.

Code 5: MANUAL FEED BOILER

These solid fuel boilers have a single top opening hopper that the householder can fill with solid fuel (open door to see). The hopper gradually releases the necessary amount of fuel into the fuel bed. The householder usually needs to refill the hopper only once a day. These solid fuel boilers tend to be located outside the habitable dwelling.

Do not classify a solid fuel closed fire with a back boiler connected to radiators as manual feed boiler.

Code 6: AUTO FEED BOILER

These solid fuel boilers have two hoppers, one for combustion and the other for the bulk storage of fuel. The fuel is fed into the combustion hopper by a feed screw. This arrangement is designed to allow the boiler to be run many days without needing refilling. Again, these solid fuel boilers tend to be located outside the habitable dwelling. The hopper feed unit may be located beside the boiler but may be located in a separate area.

Code 8: NOT APPLICABLE

Dwelling does not use solid fuel-fired heating as the primary form of heating.

M16. Electric storage heaters

The original concept of storage heaters that emerged in the late 1960's to utilise spare generating electricity capacity at night that would be stored up as heat overnight, and then released into the house throughout the next day. The heat is released through a flap at the top of the storage heater, controlled by a 'damper' or an 'output' control. Electrical heating elements are embedded in dense bricks, and it is these bricks that store the heat. The amount of heat to be stored overnight is determined by the 'charge' or 'input' control, and the charging period controlled by the time clock. Over the last 20 years, teleswitches have been replacing the traditional clocks, allowing charge periods to occur through the day rather than be strictly limited to overnight.

Storage heating is not central heating in a 'traditional' sense, that is, distributing heat through the house from a central heat source, but is considered to be a 'whole house' heating system that combined both appropriately sized storage and direct acting heaters to meet the heat load of the dwelling. The intention was the bulk of the dwelling's heat supply would be provided by the storage heaters in the specific rooms where they were located, and raise the background temperature in the other rooms through 'drift' heat. The direct acting heaters were intended to top up the heat in these rooms (as opposed to being used to meet the whole of the heat demand in these rooms).

NOTE: One storage heater still counts as the primary heating system, even when all of the other rooms have direct acting electric heaters (see Convention 2 on the conventions for identifying the Primary Heating System under Section M2 above).

All of the following types of heating are normally types of electric storage heating, and there will be an off-peak electricity supply available to the dwelling. However, where there is no off-peak supply (i.e. there is only a single meter, or a single rate meter), then all of these systems are to be recorded as direct acting electric heaters as there will be no cheap rate electricity supply to take advantage of.

Code 1: NEW STYLE

'New' storage electric storage heaters, also referred to as 'slimline' storage heaters as are much slimmer, usually 150 to 250mm deep, and are better insulated than the 'old' type (see below). Do not let the description 'new' mislead you; these "new" style electric storage heaters date back to about 1978 when a new material was used to make the high density storage bricks used in them.

NOTE: The storage heater may be a combination storage convector heater, where there is a direct acting heater as well as the storage component. These are often located in the main living area of the dwelling to allow the heat to be topped up. These combination heaters usually have a different design profile at the top when compared with normal storage heaters, as well as an On/Off

switch on the front or side of the storage heater for the convector unit. Characteristically, they tend to have two fixed supply cables. When you come across these units you record the storage heater as the Primary Heating and the direct acting, convector component as the Secondary Heating.

Code 2: FAN ASSISTED

'Fan assisted' heaters fan unit located at the bottom of the heater unit to blow air over the bricks to extract more heat from the appliance. The fan may be linked to a room thermostat control, which may be located on the wall in the room and not on the actual storage heater. The design of fan-assisted heaters tends to be one that reaches to the floor, whereas normally 'new' storage heaters usually have a gap between the floor and the bottom of the storage heater.

NOTE: Do not mistake the controls on a fan assisted heater for those on a Combination storage convector heater (Code 2). At least one company has manufactured a fan-assisted Combination Storage Heater (often referred to as a 'turbo' unit). This unit would be entered as the primary form of heating, recording Code 2 (Fan assisted) rather than Code1 (New). The direct acting convector would be entered as Secondary Heating.

Code 3: OLD STYLE

'Old' type storage heaters, also known as 'block storage' are significantly larger than 'new' slimline types, and are typically 300 - 450mm deep. They were installed in the 1960's, up to about 1978. These should be rarely encountered now.

Code 4: INTEGRATED STORAGE / DIRECT

'Integrated storage / direct' acting storage heaters are advanced versions of the storage convector heater. They combine a storage heater and a direct acting electric heater in the one case, but they are connected to a room thermostat (and maybe a time clock) or a programmable electronic thermostat so that the convector unit automatically tops up the temperature (i.e. comes on) when the room temperature drops below a set point. Integrated storage / direct acting units include the Creda EcoResponse and the Dimplex Duoheat ranges.

Code 5: UNDERFLOOR

Rather than store heat in bricks, electric underfloor heating uses the thermal mass of the floor as a heat store. Electrical cables are embedded in the floor, so that the heating elements are not seen, but often there will be separately labelled fuses at the consumer unit because of the electrical load involved.

Originally, electric underfloor systems were often tied into special ‘preserved tariffs’ as they are not available for new customers. Given the period when these systems were at the height of their popularity (that is, in the 1960s), they tended to be designed to provide only partial heating of the home, being installed in the lounge, hall and kitchen floors only (as that was the norm at the time for council housing). Their installation was often associated with concrete-constructed dwellings, and in particular, high rises.

Most of the original systems have long been obsolete and been disconnected and replaced (even if the fuses are still present) as they were almost impossible to repair. However, electric underfloor systems have begun to re-emerge, as a direct result of the increasing popularity of wet underfloor systems, particularly in very well-insulated dwellings.

Code 6: HIGH HEAT RETENTION

Modern high heat retention storage heaters can retain heat for longer and use an advanced digital controller to try to ensure that the heaters take in just enough energy overnight to keep a room warm without storing more heat than is needed. The addition of an extra on-peak electrical feed means that the heaters can use a system of fans to distribute the heat more quickly when needed, thereby maximising the efficiency of the heater. As the Glen Dimplex company introduced them into the UK market, their proprietary brand the “Quantum” storage heater has tended to become the common term of reference (e.g. like Hoover and vacuum cleaners). Dimplex and Creda (which is owned by Dimplex) both badge their high heat retention storage heaters as ‘Quantum’ on the casing. Other model names will emerge as other companies get into the market. The most obvious tell-tale is that they have built-in programmers and thermostats with LED-displays showing the temperature settings.

Code 8: NOT APPLICABLE

The dwelling does not use electrical storage heaters as the primary form of heating.

NOTE: Electrical Storage Heating must be recorded as having some form of secondary heating present in the dwelling to provide ‘top up’ heat in the dwelling. If there is no other form of heating installed in the dwelling (i.e. there are only electric storage heaters, and none of them are combined storage convector units), select electric heating as the secondary heating (i.e. code 6 at M22).

M17. Principal hot water heating source

In most cases, water will be heated by either by the main heating boiler or by an electric immersion heater (single or dual immersion). Hot water cylinders (whatever the

main method of water heating) will usually have an electric immersion heater installed as a back up system.

NOTE: You should record the main method of water heating, not the immersion, heater against this question even if the household is not using the main method of water heating. For households with a boiler system that can supply the domestic hot water and an electric immersion heater, which the household uses throughout the summer when they turn the boiler off, you should record the source of the hot water as from Code 1 'Main Heating'.

Code 1: MAIN HEATING

The primary heating system provides both the space and water heating. This code includes combi boilers, condensing boilers, and back boiler systems that provide space heating and hot water, and electric boilers that are providing hot water through indirect heating methods rather than using electric immersion heaters.

NOTE: For back boilers or kitchen ranges that only provide hot water (i.e. there are no radiators or underfloor pipework), and are not the main heating, record the source of hot water as either Code 5 (Room Heater and backboiler) or Code 6 (kitchen range).

Code 2: ELECTRIC IMMERSION

Electric immersion heaters should only be identified as the method of water heating where this is the only form of water heating available. This may be either by a single immersion or a dual immersion arrangement. Both are covered by this code.

NOTE: Do not mistake a cylinder thermostat strapped onto the outside of a cylinder for an electric immersion heater. Unlike an electric immersion heater which is internal to the hot water cylinder and enters at the top and/or bottom of the cylinder, a cylinder thermostat is usually located mid way up the cylinder, does not enter the cylinder, and is for controlling the water temperature when the hot water is supplied via the Main Heating (see Code 1 above).

Code 3: INSTANT SINGLE POINT

With instantaneous heating, regardless of whether gas or electric (or any fuel source), there will not be a hot water cylinder. This code covers the situation where the water heater provides hot water to a single sink (or in the bathroom, a sink and the bath). There may be several in the house, at each sink, the bath and even the shower.

NOTE: If there is a hot water cylinder (regardless of the source of the domestic hot water) and an instant electric shower, the principal

source of heating the hot water cylinder is the principal source of the domestic hot water, NOT the instant electric shower.

Code 4: INSTANT MULTI POINT

With instantaneous heating, there will not be a hot water cylinder. It is usually located near the sink it supplies. This code refers to an instantaneous water heater, regardless of whether gas or electric (or any other fuel source), (e.g. a water boiler) that provides hot water throughout the dwelling, usually to the sink in the kitchen and bathroom, and the bath, rather than to only one sink.

NOTE: If gas-fired, ensure that this water boiler is not a Gas Combi Boiler, i.e. that there are no radiators attached to the water boiler. The most common instance of water boilers is in dwellings with warm air heating.

Code 5: ROOM HEATER BB (i.e. BACKBOILER)

The hot water is from a room heater that has a back boiler attached to it and that this room heater is **not** the main heating in the dwelling. The most likely instance will be where there is still a back boiler behind / attached to room heater without any radiators that is still used to heat the hot water, but there is another form of heating within the dwelling that is the main heating source in the dwelling.

Code 6: KITCHEN RANGE

The hot water is from a kitchen range (i.e. range cooker boiler) that is providing **ONLY** the hot water.

NOTE: If the range cooker boiler is the primary heating source (i.e. Code 7 at M7) and providing the hot water, then the hot water source is recorded as Code 1, from the 'primary heating'.

Code 7: OTHER SYSTEM

If you have identified more than 1 main heating system in the dwelling, and therefore have entered 'yes' in M21a, and the hot water is provided by any system other than the one that you identified as the main heating in M2, then select this option. Do not use it where the hot water is provided by a secondary room heater (see Code 5 and Code 6 above for those situations).

Code 8 NOT APPLICABLE

There is no hot water heating system in the dwelling.

M18. What is the water heating fuel?

The codes and the descriptions for the water heating fuels are identical to those for the primary heating fuel codes. As in most cases the hot water will be supplied by either the primary heating boiler or by an electric immersion heater then the likelihood is that the water heating fuel will be the same as the primary heating system, or peak or off-peak electricity.

Where an appliance can be fed with different fuel types, you should record the fuel type according to the following sequence: GAS ->OIL->SOLID FUEL->ELECTRICITY.

Code 01: GAS (MAINS)

The primary source of hot water is a heater fuelled by an appliance connected to the mains gas grid.

Code 02: BULK LPG (Liquefied Petroleum Gas)

The primary source of hot water is a heater fuelled by an LPG-fired boiler connected to a large storage tank located outside the dwelling.

Code 03: BOTTLED GAS

Usually known as 'Calor Gas' or 'Flo Gas' or 'MacGas'.

The primary source of hot water is a heater fuelled by stand alone LPG cylinders usually located outside the dwelling. Where there is more than one cylinder present they are often linked together via a regulator valve.

Code 04: OIL

The primary source of hot water is a heater fuelled by oil.

Code 05: HOUSE COAL**Code 06: SMOKELESS****Code 07: ANTHRACITE****Code 08: WOOD CHIPS****Code 09: WOOD LOGS****Code 10: WOOD PELLETS**

The primary source of hot water is a heater fuelled by solid fuel.

NOTE: Within a known designated smokeless area, the presumption should be that the solid fuel being used is 'smokeless' (ie. code 6).

NOTE: Where it is obvious that the household is using both a mineral solid fuel (i.e. some form of coal) AND some form of wood fuel, and the dwelling is not in a designated smokeless zone, then this situation can be accommodated by using Dual Fuel (Code 16 below).

Code 11: PEAK ELECTRIC

The primary source of hot water is an electric immersion heater or instant electric water heater on the standard domestic tariff (i.e. indicated by a single electric meter with only one set of dials or digits or one rate on the meter display).

Code 12: OFF PEAK ELECTRIC

The primary source of hot water is an electric immersion heater on an off-peak tariff as evidenced by two or more separate meters being present; one meter with at least two sets of digits or dials, or more commonly now the newer digital display meters, the meter will display more than one rate being present.

Code 13: COMMUNITY HEATING WITH NO CHP**Code 14: COMMUNITY HEATING WITH CHP**

CHP stands for Combined Heat and Power. A CHP scheme produces both heat AND electricity.

Most community heating schemes provide only space and water heating (e.g. via a group heating or district heating boiler plant) so will be recorded as Code 13 here (i.e. Community Heating with NO CHP).

Alternatively, if the unit also produces electricity, as well as the space heating and hot water, then record here it as Code 14 (i.e. Community Heating with CHP).

NOTE: If the community heating or CHP scheme does not provide the domestic hot water record the primary source of the hot water at M17 as appropriate and the fuel here.

Code 15: BIOGAS (Landfill)

The primary source of hot water is a heater fuelled by biogas (i.e. methane)

Code 16: DUAL FUEL

This code provides an alternative to a single solid fuel being recorded under Codes 5 to 10 above where it is obvious that the household is using both a mineral solid fuel (i.e. coal) AND wood for fuelling their hot water supply.

Code 17: OTHER (SUREYOR NOTES)

You should not have to use this code.

Code 88: NOT APPLICABLE

Use this code if none of the above options apply. This will be very rare.

Code 99: UNOBTAINABLE

This code should be used if you are unable to gain access to the heating to determine the Primary Heating fuel.

M19. Central heating source

Disrepair of the central heating source (e.g. the boiler, the warm air unit or the electric storage heaters) is assessed using a 5 point scale.

Code 0: NO REPAIR 0%

There are no repairs required.

Code 1: SMALL REPAIRS up to 5%

With a wet central heating system Code 1 equates to a renewal of a control.

Code 2: MINOR REPAIRS 5-25%

With a wet central heating system Code 2 equates to a renewal of the pump. With a dry central heating system Code 2 equates to an overhaul, adjustment and resetting of the controls.

Code 3: MEDIUM REPAIRS 25-60%

With a wet central heating system Code 3 equates to renewal or relining of boiler flue. With a dry central heating system Code 3 equates to a renewal of the flue and the air supply.

Code 4: RENEW 60-100%

With a wet central heating system Code 4 equates to a complete renewal of the boiler with or without the replacement of flue controls and pumps.

With a dry central heating system Code 4 equates to repairs ranging from the renewal of the distribution system to a renewal of the flue and the heat exchanger (or separate central heating controls for an electric system).

Use Code 4 (Renew) where the boiler has been stolen or where it has been removed by the landlord to prevent theft.

Code 8: NO AMENITY

The dwelling does not have a central heating system.

Code 9: UNOBTAINABLE

You are unable to gain access to the central heating source.

M20. Central heating distribution repairs

Disrepair of the central heating distribution system (e.g. the pipework and radiators) is assessed using a 5 point scale.

Code 0: NO REPAIR 0%

There are no repairs required.

Code 1: SMALL REPAIRS up to 5%

With a Wet Central Heating System Code 1 equates to ½ valve replacements or ½ TRV's.

Code 2: MINOR REPAIRS 5% 25%

With a wet central heating system Code 2 equates to renewal of up to 1/3 of the radiators in the system.

With a dry central heating system Code 2 equates to minor repairs to duct work, power outlets or main thermostat.

Code 3: MEDIUM REPAIRS 25-60%

With a wet central heating system Code 3 equates to the renewal of approximately half of the radiators in the system or renewal of all pipework and valves.

With a dry central heating system Code 3 equates to the renewal of the distribution system to one room in the dwelling.

Code 4: RENEW 60-100%

With a wet central heating system Code 4 equates to the renewal of all radiators in the system with or without the renewal of all pipe work.

With a dry central heating system Code 4 equates to repairs ranging from the renewal of 50% of the distribution system to the renewal of all the duct-work and outlets/floor or ceiling elements/storage heaters.

Code 8: NO AMENITY

The dwelling does not have a central heating system.

Code 9: UNOBTAINABLE

You are unable to gain access to the central heating source.

M21. Heating controls for primary heating

Heating controls are used to ensure that the level, time and location of primary space heating within the dwelling is controlled by the occupants to avoid unnecessary expense.

For wet central heating systems (M2 codes 1 and 2) the range of controls may include programmers (i.e. time clocks), room thermostats, and / or thermostatic radiator valves (TRVs) in various permutations or even a Boiler energy manager system. The boiler thermostat is ignored here.

For electric storage heating systems, (M2 code 3), the choice of controls will be between manual or automatic charge control.

For individual room heaters (M2 code 4), the choice of controls may include programmers (i.e. time clocks) and thermostats in various permutations located on the actual appliance or on the wall in the dwelling.

For warm air systems (M2 code 5), the range of controls may include programmers (i.e. time clocks) and room thermostats in various permutations.

For heat pump systems, the range of controls will be dependent on whether the system is a wet or dry system. In a wet system with radiators or underfloor pipework, then the range of controls will be as with other wet systems above. With ground/air/water-to-air systems the range of controls will be in keeping with warm air systems.

NOTE: **The on/off switch to the primary heating source does not form part of this assessment of controls.**

Code 01: NO CONTROLS

The primary heating system has no method of control other than an on/off switch. A wet central heating system with only a boiler thermostat or a back boiler system with only a pump would fall into this category.

Code 02: PROGRAMMER ONLY

This code applies to wet central heating systems, warm air systems and heat pump systems (M2 codes 1, 2, 5 and 6). It could also apply to a room heater system (M2 code 4).

Programmings (i.e. time clocks) enable the occupants to set the central heating system to turn on/off at different times of the day (and possibly different days).

It may be either a round mechanical type (with an actual clock face) or, increasingly more likely, an electronic one with a LCD display. Often located adjacent or near to the primary heating source, or in the kitchen. Some are sited on the actual boiler.

Code 03: ROOM STAT ONLY

This code applies to wet central heating systems, warm air systems and heat pump systems (M2 codes 1, 2, 5, and 6). It will also apply to a room heater system where the room heater is controlled by a room thermostat on the wall (if the thermostat is on the primary room heater appliance use Code 9 below).

Room stats turn the primary heating on/off according to the room temperature. There will generally only be one room stat in the dwelling that is often located in the living room or hall. Almost always they are of a dial type marked in either Celsius or Fahrenheit enabling the occupants to set their desired room temperature. Generally, room stats were not installed in much of the new build of the 1980s and early 1990s where TRVs were installed on individual radiators. They have returned in later new build housing as a result of the Building Regulations.

Code 04: PROGRAMMER AND ROOM STAT

This code applies to wet central heating systems, warm air systems, and heat pump systems (M2 codes 1, 2, 5 and 6).

The dwelling's primary heating system has both a programmer and a room stat. Refer to codes 2 and 3 for definitions.

NOTE: A modern development is the digital 'programmable electronic thermostat'. It looks like a digital programmer but combines this function with the ability to control the room temperatures. It will have both a 'time' and 'temperature' reading on the display. Such devices are to be recorded here as they do both jobs. Examples include the Potterton PET, the Digistat 3 and the Digistat 4.

Code 05: PROGRAMMER, ROOM STAT AND TRVs

This code applies to wet central heating systems, and heat pump systems (M2 codes 1, 2 and 6). Warm air systems do not have radiators so do not have TRVs.

The dwelling's primary heating system has a programmer, a room stat and TRV's. Refer to codes 2, 3 and 8 for the individual definitions.

Code 06: PROGRAMMER AND TRVs

This code applies to wet central heating systems, and heat pump systems (M2 codes 1, 2 and 6).

The dwelling's primary heating system has both a programmer and TRVs, but no room thermostat. Refer to codes 2 and 8 for the individual definitions.

This combination was common during the 1980's and 1990's. After 1997, new homes usually needed a room thermostat to comply with the Building Regulations.

Code 07: BOILER ENERGY MANAGER

This code applies to wet central heating systems, and heat pump systems (M2 codes 1, 2 and 6).

ALL of the dwelling's controls are managed by a centralised control unit. The system will usually feature programmers, room thermostats and TRV, but will also include an external weather sensor. The systems often feature delay start control, night setback, and frost protection. The tell tale feature of a Boiler Energy Manager system is usually the large amount of wiring (from all of the controls in the dwelling) coming back to electronic control boxes (where all of the information is processed) near the boiler. These systems tend to be too expensive for normal sized dwellings but feature in very large dwellings.

Code 08: TRVs ONLY

TRVs are installed on individual central heating radiators. They enable the occupant to set their desired room temperature, above which the valve closes to avoid over heating of the room. They are 'barrel shaped' located close to the floor where the central heating pipes are attached to the radiator, and will have some form of scale on them. They do not tend to actual temperatures marked on them. They may be fitted either at the bottom or the top of the radiator where the hot water flows

into the radiator, and replace the normal 'lock-shield' valve (i.e. the valve to turn the radiator off completely).

This code applies to wet central heating systems, and WET heat pump systems (M2 codes 1, 2 and 6).

The dwelling's primary heating system has only TRV controls. This is very rare.

Code 9: APPLIANCE STAT

This code is for room heaters only (M2 code 4).

The dwelling's room heaters are individually controlled by an appliance thermostat that turns the room heater on/off according to the temperature in the room and the occupants' preferences. The device will have some sort of scale. It may be in degrees or it may be a numeric scale (such as 0-6). It is located on the room heater itself.

Code 10: APPLIANCE STAT AND PROGRAMMER

This code is for room heaters only (M2 code 4).

The dwellings room heaters are individually controlled by an appliance stat and a programmer. For definitions refer to codes 2 and 8

Code 11: MANUAL CHARGE CONTROL

This code is for storage heaters only (M2 code 3).

Manual charge controllers require the occupant to set the level of electricity charge / input the storage heater receives (generally at night) which determines the amount of stored heat that can be released during the day. This control is generally a numbered dial located on each storage heater. This control is often labelled 'input' 'charge' or 'boost' The charge level determines the amount of heat the storage heater gives off.

NOTE: If the operation of the electric storage heater is still controlled by a time clock, it will be Manual Charge Control. Teleswitched controls were installed to control the time of charging, not the amount of the electricity charge. Without additional 'features' built into the teleswitch control (see below) they are only Manual Charge Control.

Code 12: AUTO CHARGE CONTROL

This code is for storage heaters only (M2 code 3).

Automatic charge controllers control allows the charge to the storage heater to vary with changing weather conditions. The level of electricity the storage heater receives (generally at night) will be varied according to changes in the external weather temperature. They will control the charge to all of the storage heater units within the dwelling.

When originally introduced in Scotland at the end of the 1980s and early 1990s, automatic storage controls involved fitting external weather sensors to individual dwellings wired back to a central controller located inside the dwelling usually near to the consumer unit.

Since the early 1990s, both ScottishPower and Scottish Hydro, have introduced remote controlled weather compensation through the use of teleswitches. Examples are dwellings connected to Scottish Power's 'Weather Call' system, or Scottish Hydro's 'Total Heating Total Control' tariff. Although ScottishPower uses the teleswitches for its Weather Call system, not all of its teleswitches are 'weather controlled'. ScottishPower's teleswitches should have a 'Group Code' number on them that will allow for the tariff to be determined, see table on below. ALL Scottish Hydro's 'Total Heating Total Control' customers are weather compensated, regardless of any Group Code than may be on the meter, so are considered to have Auto Charge Control.

NOTE: To date, other electricity suppliers in Scotland have NOT opted into these weather compensation systems through the teleswitches so are considered to only be Manual Charge Control.

1. Diagram M21: Scottish Power's Radio Teleswitch Group Codes in use since 1 January 1998

CODE	Tariff	Districts	Dates	Section M
97, 100 & 103	Weathercall System	Ayrshire, Lanarkshire, Dumfries and Galloway and Central (West)	01/10/87 to present	M20 Code 12 (auto charge control)
98, 101 & 104	Weathercall System	Glasgow and Clyde	01/10/87 to present	M20 Code 12 (auto charge control)
99, 102 & 105	Weathercall System	Edinburgh, Borders, Fife and Central (East)	01/10/87 to present	M20 Code 12 (auto charge control)

For all other codes not listed above the storage heater has a manual charge control (M20 Code 11).

Code 13: >1 STAT

This code applies to wet central heating systems, warm air systems and heat pump systems (M2 codes 1, 2, 5, and 6). It will also apply to a room heater system where the room heater is controlled by a room thermostat on the wall (if the thermostat is on the primary room heater appliance use Code 9 above).

There is more than one room thermostat in the dwelling, but no other controls.

Code 14: TIME/TEMP ZONE CONTROL

This code applies to wet central heating systems, warm air systems and heat pump systems (M2 codes 1, 2, 5, and 6).

Zone control allows the heating in at least two separate zones of the dwelling to be controlled independently for BOTH time and temperature (for example, the main living room and the rest of the dwelling, or downstairs and upstairs). To qualify as time and temperature zone control, the dwelling must have all of the following:

- at least two thermostats (one each zone) and/or TRVs on all radiators in a wet system
- separate plumbing circuits for each zone (often controlled by separate motorized zone valves)
- separate programmers for each zone (or a multi-channel programmer, usually with at least 3 channels – one for each heating zone and one for the hot water. There may be more.)
- If the dwelling complies with all three of these conditions then it has time and temperature zone control. Larger dwellings (i.e. more than 150 m²) built since the 2002 Building Regulations came into effect are meant to have time and temperature zone control under the Part J requirements.

NOTE: TRVs on all radiators are not enough to qualify as time and temperature zone control.

Code 15: PROGRAMMER 2 STATS

This code applies to wet central heating systems, warm air systems and heat pump systems (M2 codes 1, 2, 5, and 6).

There is more than one room thermostat in the dwelling, and a single time clock or programmer. The dwelling has some of the features of the time and temperature zone control system but does not meet all of the requirements to have be considered to controlled independently for time and temperature.

Code 16: OTHER – SURVEYOR NOTES

If other controls are encountered over and above those listed above (e.g. external weather sensors, load compensators, delay start thermostats) just note them in the surveyor's notes. If not sure what they do, take a photo of them.

NOTE: Where no controls are present, other than the primary heating source on/off switch you should use Code 1: NO CONTROLS

M21a. Does the dwelling have another heating system?

Where there is a second main system (or more) over and above the main heating identified in M2, then this is indicated via this question and the adding surveyor's notes.

Code 1: NO

There is only one main heating system in the dwelling and that has already been identified via M2 and subsequent questions.

Code 2: YES

There is at least one other heating system in the dwelling. If this option is selected then include details in the surveyor's notes. Use the questions for identifying the main heating system to guide the information provided, including the type, age manufacturer make and model number of the boiler (if it is a boiler system). Importantly, note the percentage of the floor area heated by this second heating system.

NOTE: If the dwelling has one main heating system (M2) and two types of room heater, identify the type of room heater in M22 as per conventions set out there and ignore the rest. Do not enter a second room heater as a second main heating system.

Code 8: NOT APPLICABLE

Applies only if the main heating is a type of room heater (i.e. Code 4 in M2.)

Code 9: UNOBTAINABLE

This code should be used if you are unable to gain access to the heating to determine the main water heating fuel.

M22. Are any other fixed room heaters present?

Where a dwelling has one or more fixed room heaters **in addition** to the main heating system identified in M2, this supplementary form of heating is recorded at this question.

Where Room Heaters are the recorded as the main heating at M2, then this question would be used to identify a second (and different type of room heater found within the dwelling).

NOTE: All supplementary heating options are types of Room Heaters. A system **CANNOT** be a secondary heating system. Systems are recorded first in M2, and if a second system present, in M21a.

NOTE: Storage heating must have some form of secondary system (see note at end of section M16 above).

Conventions for Identifying the Fixed Room Heater

Where you are faced with a choice between two or more different types of additional room heater in the in a dwelling, follow the conventions below to identify the appropriate one to enter on the survey form:

- 1. the type of room heater that heats the most rooms in the dwelling, with a bias of habitable rooms over other rooms; and a bias of the living room over other habitable rooms.
- 2. where they heat a similar number of rooms and cannot be distinguished under convention 1, select the one with the lowest running costs as the main form of heating (i.e. fuel price / heater efficiency, so, gas over oil over solid fuel over electricity).
- 3. where there are two or more different fixed room heaters in the dwelling, once you have identified the room heater in M22, ignore the rest.
- Do not enter a second room heater as Main Heating 2 in M21a.
- Code 0: NO OTHER ROOM HEATERS

There is only the main heating system (or multiple systems) installed in the dwelling, and that was identified as the primary heating in M2 (and M21a, where appropriate) above.

Code 1: GAS, COAL EFFECT FIRE

These gas fires are designed to look like a real coal fire but will be “cleaner”. Unlike a real fire there is unlikely to be a supply of solid fuel beside the fireplace to allow the occupants to keep the fire alight.

Gas, coal effect fires are often installed in existing fireplaces and occupy the whole of the fireplace’s opening area. The gas pipe may be visible but is often concealed. Controls for the fire are generally hidden behind the “ash box” door.

Select this code where the combustion gasses from the gas coal effect fire are vented directly up a flue or chimney. Some types of flue are installed in the cavity of an external cavity wall. This code will include coal effect fires with a balanced flue.

NOTE: Unlike the distinction used when these room heaters are the main heating source (see codes 2 and 3 at M14), no distinction is used when they are just the secondary heating. This code covers both decorative fires (see code 3 at M14) and coal effect flued fires (see code 2 at M14).

Code 2: POST-1980 GAS FIRE

Most gas fires (both mains gas and LPG-fired) will fall within this category. This will include gas fires with normal flue arrangements in

front of a chimney breast and wall mounted balanced flue gas fires that are flued directly through the wall.

NOTE: If the secondary heating is a flueless gas fire, use Code 7 (Other), and then identify the flueless gas fire in the Surveyors Notes (to allow its higher efficiency to be used in the assessment).

NOTE: Gas convector heaters were included in some wet central heating systems (common during the last 1960s and early 1970s, but more modern examples exist). These will include an On/Off switch for the fan with some electrical wiring attached. Usually a thermostat control, and have no external flue. These heaters are to be classified as part of the primary heating system, i.e. Code 1: Boiler, and are not to be coded separately as either room heaters or secondary heating because they do not actually burn gas.

Code 3: PRE-1980 GAS FIRE

Old style fires are rare, and have no convector unit or grille on the top of the heater. Given their age, very few of these will be encountered as they are likely to have been replaced.

NOTE: Where there is a gas-fired back boiler with a gas fire in front of the back boiler, the back boiler is a system identified in M2 or M21a, and the gas fire will be entered separately in M22 as either Code 2 or Code 2).

Code 4: OPEN SOLID FUEL FIRE

The fireplace has a chimney breast and a grate. The fuel may be any form of coal, wood or peat.

NOTE: An open fireplace on the ground floor of a dwelling (for example in the lounge or dining room) (whether used or not by the household) should be counted as a Secondary Form of heating under this option unless the fireplace is permanently blocked up and/or sealed. Where there are open fireplaces on the upper floors, and they are not used by the occupants, then these are NOT counted as Secondary Heating.

NOTE: Ensure that the Open Solid Fuel fire is not really a 'coal effect' gas fire.

Code 5: CLOSED SOLID FUEL FIRE

The fuel is burned within an enclosed appliance with a door at the front. The heater may be located within the fireplace or elsewhere in the room.

NOTE: Ensure that the Solid Fuel Closed Fire is not really a 'coal effect'

gas fire.

NOTE: Where there is solid fuel back boiler system, whether an open fire with back boiler or a closed heater with back boiler, then the system is considered and scored as a single entity (which is different than with a gas fire in front of the back boiler). You would only use Code 4 or Code 5 here, if there is a separate open fire or closed room heater in the dwelling in addition to the one with the back boiler.

Code 6: ELECTRIC ROOM HEATERS

Electric bar fires, electric fan heaters, electric oil-filled radiators, electric panel heaters, electric down flow heaters, electric radiant heaters, and the direct acting element on a Convector Storage Heater are all included here. More than one of these may be present, but they can all just be 'lumped' together as electric room heaters, which might influence the room count when considering which heater to select as the fixed room heater.

Code 7: OTHER - SPECIFY IN SURVEYOR NOTES

Use this code if none of the above options apply, but there is a secondary form of heating present within the dwelling or where there is a flueless gas fire as the secondary heating.

M23. Heating in conservatory

Refer to D6 for the definition of a conservatory.

If the conservatory has more than one form of heating present choose the form of heating source in the following order:

- 1st Direct from Main System
- 2nd Fixed Heater
- 3rd Portable heaters

Code 1: NO HEATING

The dwelling has a conservatory. The conservatory does not have any form of fixed heating or portable heating present.

Code 2: DIRECT FROM HEATING SYSTEM

The conservatory has a radiator, underfloor heating, warm air outlet grille or storage heater (M2 code 1 – 3 & 5) located within the conservatory. This form of heating is part of the dwellings main heating system.

Code 3: FIXED HEATER

The conservatory is heated by a fixed heater located within it. Fixed heaters include gas fires, fireplaces and electric fires that are hard wired.

Code 4: PORTABLE HEATERS

At the time of survey a portable heater is actually present in the conservatory and seen by the surveyor. Portable heaters include calor gas heaters, paraffin heaters and portable electric fires.

NOTE: This code should only be used when no other form of heater is present in the conservatory (Codes 2 and 3).

Code 8: NO CONSERVATORY

The dwelling does not have a conservatory.

Code 9: UNOBTAINABLE

You are unable to determine the form of heating (if any) within the conservatory.

M24. Is there a door separating the dwelling from the conservatory?

You are not required to assess the state of repair of any separating door, nor the occupants' use of any such door for this question.

If the conservatory is not accessible from within the dwelling, then it is a greenhouse and not a conservatory.

NOTE: Half height and louvered doors are not acceptable for the purposes of this question and you should use Code 1, NO where such doors separate the dwelling from the conservatory.

Code 1: NO

There is **NO** door separating the dwelling from the conservatory. You need to add extension/conservatory details at N6 or N7, together with details of the age at Q26 or Q35.

Code 2: YES

There **IS** a separating door between the dwelling and the conservatory. No details are required at N6 or N7 nor at Q26 or Q35.

Code 8: NO CONSERVATORY

The dwelling does not have a conservatory.

Code 9: UNOBTAINABLE

You are unable to determine whether there is a door present between the dwelling and the conservatory.

M25. IS THE GAS/OIL HEATING SYSTEM SAFE?

This assessment of the safety of a gas or oil system and / or appliances within the dwelling takes into consideration an overall assessment of the physical condition of the appliances, the gas / oil supply to the appliances, as well as the flueing and ventilation arrangements.

Natural gas, LPG and oil are potentially dangerous substances. This assessment of the safety of the gas system and or appliances within a dwelling is a visual rating of the safety of the gas or oil system or appliances using the guidance provided by the Scottish Household Survey. In no way should this visual assessment of the gas or oil system or appliances, or the guidance, be considered, construed or seen to replace a gas or oil safety check or an inspection of the gas or oil appliance carried out by a qualified person under the requirements and regulations as set out by GAS SAFE, OFTEC and / or the HSE.

Recording the gas or oil system or appliances as 'unsafe' here does not imply necessarily that the system is dangerous. Conversely, recording the gas or oil system as 'safe' does not imply necessarily that there is not a problem. The Surveyors for the Scottish Household Survey are not qualified to make such a definitive assessment.

We have consulted with OSSE and their view is that the **surveyors do not need to be GAS SAFE registered** to carry out a visual inspection of the heating system within the dwelling as **the SHS is not specifically a gas safety inspection**. The same applies with oil systems. Additionally, **surveyors are not legally obliged to inform the householder that something is wrong but OSSE feels that we have a moral obligation to suggest that householders have the appliance inspected by a qualified contractor if we identify something that is of concern**.

Further details are provided in Section 9.

Code 1: YES, THE GAS/OIL HEATING SYSTEM IS SAFE

The system is visually deemed safe as per the instructions set out in Appendix M25.

Code 2: NO, THE GAS/OIL HEATING SYSTEM IS UNSAFE

The system is visually deemed unsafe as per the instructions set out in Appendix M25.

Code 8: NOT APPLICABLE

There is no gas or oil heating or hot water system or appliance present in the dwelling.

Code 9: UNOBTAINABLE

This code should be used if you are unable to gain access to the heating to determine if there was a gas or oil heating system or appliance present in the dwelling.

M26. Average depth of roof/loft insulation to original dwelling?

The **TOTAL** thickness of loft insulation is to be recorded (see Codes below), i.e. **whatever was installed** when the dwelling was built **plus any subsequently added**.

Where the level of insulation varies, you should estimate the average thickness of the insulation across the overall roof space. Thus, if half of the loft area has 100mm of insulation and the rest none, the average would be 50mm.

NOTE: Do not look solely around the loft hatch opening, as the insulation in this area tends to get compressed when people access the loft space. Be sure to look out into areas near the eaves to ensure coverage (although you are not expected to actually enter the loft space). Items stored in the loft space do not constitute insulation and are therefore ignored in the averaging out of the total Insulation thickness. Unless it can be determined that partially boarded areas have loft insulation beneath the boards, then the presumption is there is none – this presumption is to be factored into the averaging out of the loft insulation thickness.

You should not attempt to guess the thickness of the loft insulation.

- Code 00: NONE**
- Code 01: 12mm**
- Code 02: 25mm**
- Code 03: 50mm**
- Code 04: 75mm**
- Code 05: 100mm**
- Code 06: 150mm**
- Code 07: 200mm**
- Code 08 : 250mm**
- Code 09: 270mm**
- Code 10: 300mm**
- Code 11: 350mm**
- Code 12: 400mm or more**
- Code 13: FLAT SLOPING ROOF/UNMEASURED**
- Code 88: NOT APPLICABLE**

The roof is a non heat loss roof (e.g. a mid-floor or ground floor flat).

- Code 99: UNOBTAINABLE**

Where the thickness of the insulation cannot be determined because of a lack of access to the loft space, you should enter Code 99. The

computer program will select as a default the appropriate Scottish Building Regulation standard for dwellings of the relevant age.

M27. Insulation location

To assign the correct default U-value to the loft insulation, the position of the insulation is needed as changes to the Building Regulations have set different standards for different roof constructions, such as where the insulation is between the joists (i.e. a traditional pitched roof construction with an attic space), where the insulation is between the rafters (i.e. a warm roof construction where the insulation is in the slope of the ceiling) and where the insulation is in a flat roof construction.

Code 1: RAFTERS

The roof insulation is in the slope of the roof. It is possible in such warm roof constructions that the thickness of the insulation will not be able to be measured.

Code 2: JOISTS

The roof insulation is between or between and over the joists in the attic space. In such instances as long as there is access to the loft then it should be possible to measure the thickness of insulation.

Code 3: FLAT ROOF

The insulation (if there is any is within the flat roof construction) and it is unlikely that the thickness of insulation will be measureable.

Code 4: BOTH (JOISTS & RAFTERS)

This situation will apply where there is a room built into the roof space. It may also apply where the dwelling has an attic space with insulation between the joists and insulation has been also placed on the underside of the roof between the rafters. In such a situation ONLY measure the thickness of the insulation between the joists – do not include the thickness of the insulation between the rafters, i.e. do NOT add the two thicknesses together.

Code 8: NOT APPLICABLE

The roof is a non heat loss roof (e.g. a mid-floor or ground floor flat).

Code 9: UNOBTAINABLE

This option should be rare; an estimate of the insulation position should be possible.

M28. Is there a loft hatch?

Is there access to the loft from within the dwelling through the ceiling? If so, is it draughtproofed? Loft hatches that are not draughtproofed are the greatest contributor to condensation within the loft space.

It would be possible (particularly in dwellings with rooms in the roof) to have both lofts and eaves. As its more important to identify the draught-proofing of the loft hatch, use code 2 or 3 in these cases.

NOTE: Loft access in the common stairwell of a block of flats is not counted (it would code as Code 1). The draught-proofing of the loft hatch is not an assessment of whether the loft hatch is insulated on the loft side.

- Code 1:** NO
- Code 2:** YES, NOT DRAUGHT-PROOFED
- Code 3:** YES, DRAUGHT-PROOFED
- Code 4:** EAVES DOOR
- Code 8:** NOT APPLICABLE / NO LOFT
- Code 9:** UNOBTAINABLE

M29. Size of hot water cylinder (Litres)

You are required to specify the approximate cylinder size. Common cylinder sizes are shown in Table M29_a1, with the most common being about 110 litres (about 25 gallons) size, which would fall within the 'Normal (90-130 litre)' category. With the increasing frequency of combi boilers, fewer properties have hot water cylinders.

The size may be listed on a label or plate attached to the cylinder. Alternatively, the size of the hot water cylinder can be estimated by measuring both the height and the diameter (ignoring any insulation) and comparing the results with Table M29_a2.

DIAGRAM M29_A1 – Common Cylinder sizes

825 x 450	110 litres
900 x 400	96 litres
900 x 450	120 litres
1050 x 400	115 litres
1050 x 450	144 litres
1500 x 450	218 litres

DIAGRAM M29_A2 – Water content (litres) for different size cylinders

		Cylinder diameter in mm without insulation							
		300	350	375	400	425	450	500	600
Height in mm without insulation	600	35	48	55	60	70	77		
	750	45	62	70	80	90	98		
	825	50	69	78	89	100	109		

	900	55	74	87	96	110	120	150	
	975	60	83	95	107	120	135	164	
	1050	65	90	103	115	130	144	178	257
	1200	75	103	118	134	150	166	200	290
	1350	85	116	133	152	170	194	234	339
	1500	95	130	148	170	190	218	255	370
	1800			180	206	230	265	320	450

Code 1: SMALL (<90Litres)

Code 2: NORMAL (90 – 130 litres)

Code 3: MEDIUM (>130 – 170 litres)

Code 4: LARGE (>170 litres)

Code 8: NO HOT WATER STORAGE

The dwelling does not have a hot water storage cylinder present within the dwelling.

Code 9: UNOBTAINABLE

There is a hot water cylinder but for whatever reason no access to it is possible.

M30. Type of insulation to hot water storage cylinder?

You are required to ascertain the type of insulation installed on the hot water storage cylinder. If the **hot water storage cylinder is redundant through the subsequent installation of a combi boiler** or other water heating method **you should choose code 8, “No Hot Water Storage”**.

Code 1: SPRAYED

The hot water storage cylinder has spray foam insulation.

Code 2: JACKET

The hot water storage cylinder has a quilted insulation jacket.

Code 3: ENCAPSULATED

The hot water storage cylinder has an outer metal casing so that the insulation is completely unseen. Elson tanks with factory-installed insulation within hardboard boxes around the cylinder, or metal or plastic encased cylinders with insulation between the casing and the cylinder come into this category.

Code 4: BOTH (JACKET & SPRAYED)

The hot water storage cylinder has BOTH spray foam insulation and a jacket over top of the spray foam.

Code 5: NO INSULATION

The hot water storage cylinder is not insulated.

Code 8: NO HOT WATER STORAGE

The dwelling does not have a hot water storage cylinder present within the dwelling.

Code 9: UNOBTAINABLE

There is a hot water cylinder but for whatever reason no access to it is possible.

M31. Thickness of insulation to hot water cylinder

You are required to establish the thickness of the hot water cylinder insulation, and record the details in mm. This may require the thickness be averaging out if there are areas that are insulated and areas that are not. Uninsulated areas should be weighted more in any such averaging.

SPECIFY THICKNESS (in mm)

Where there is both spray foam and a jacket present (code 4 at M30) add the thickness of the spray foam to half the thickness of the jacket to calculate the thickness of the hot water insulation thickness to enter here.

Code 888: NO HOT WATER STORAGE

This code should be used for dwellings that have no hot water storage, or only have instantaneous systems like Combi boilers and gas multi points.

Code 999: UNOBTAINABLE

There is a hot water cylinder but for whatever reason no access to it is possible.

M32. Is there a cylinder thermostat?

A cylinder thermostat controls the temperature of the water in the hot water storage cylinder supplied via the Primary Heating. When the water is up to the pre-set temperature the supply will shut down. It is usually strapped onto the outside of the cylinder (no more than half way up the cylinder) but in contact with the cylinder (where there is spray foam, a small amount will be cut away for the cylinder thermostat to be located.) There will usually be cable running from the cylinder thermostat as well. There are arrangements whereby a device similar in appearance to a TRV may be fitted onto the hot water supply to the cylinder (with a thermal couple cable running from the valve to the cylinder) that does the same job as a cylinder thermostat and is to be recorded as a cylinder thermostat.

Code 1: YES

There is a cylinder thermostat present.

Code 2: NO

There is a cylinder but there is no cylinder thermostat present.

Code 8: N/A

There is a no hot water storage cylinder present.

Code 9: UNOBTAINABLE

There is a hot water cylinder but for whatever reason no access to it is possible.

M33. Is the insulation to hot water pipers in loft satisfactory?

This question refers to pipework associated with **BOTH** the distribution of heat within a wet heating system **AND** pipes delivering hot water to the taps.

Code 1: YES

ALL of the hot water pipes in the loft space belonging to the surveyed dwelling are satisfactorily insulated.

NOTE: You should include under this code tanks and pipes that are covered with a general insulation blanket; or are completely located in a space with a rigid insulation system fixed to the underside of the roof timbers (warm roof).

Code 2: NO

Some of the exposed hot water pipes in roof/loft space have no insulation.

NOTE: This code should be used for situations where the loft may be insulated at the lower ceiling level while the hot water pipes are left exposed above. It also includes situations where the hot water pipes have been insulated but there are bare bits of pipework that can still be seen, exposed bends, or the insulation falling off the pipework so that it is partly exposed.

Code 3: NO INSULATION

There are hot water pipes in the loft space, but they are completely uninsulated (i.e. none of the hot water pipes in the loft space have any insulation at all).

Code 4: NO HOT WATER PIPES IN LOFT

There are no hot water pipes in the loft space.

NOTE: There may still be cold water pipes but these are dealt with separately in the next section.

Code 8: NOT APPLICABLE (NO LOFT)

The hot water pipes belonging to the selected dwelling are not located within a roof/ loft space belonging to the surveyed dwelling, or the dwelling does not have a heat loss roof (e.g. a mid-floor or ground floor flat).

Code 9: UNOBTAINABLE

You are unable to gain access to the roof/loft space.

M34. Is the insulation to cold water tanks and pipes in loft satisfactory?

This question refers to pipework associated with the storage of cold water in the loft space and any pipework for distributing water around the dwelling. The presence of such pipework and tanks in loft spaces are likely to be significantly more common than the presence of hot water pipes (as assessed under M33).

Extract from the Scottish Government's specification for Loft Insulation (Under the Central Heating Program)

B12.5.4 Preventing the Freezing of Pipes and Tanks

As far as is practical, pipes should be located below the loft insulation. Where pipes sit above the loft insulation they should be insulated to standards for indoor standards as set out in BS 5422: 1990, BS 3958 and BS 6700: 1987, where appropriate. Care must be taken to ensure that no part of the pipes particularly at elbows, and entry and exit points to tanks are left exposed. Where existing pipework insulation meets BS 5422: 1990 and is fitted to ensure no pipes or part of pipes are left exposed and where no evidence exist of pipes being wet or saturated, no additional insulation should be fitted. No works should commence on pipes if it is considered that such action will result in damage to these pipes.

B12.5.1 Cold water cisterns and tanks

Cold water cisterns and tanks located in the loft space must also be insulated in strict accordance with British Standard BS 5422: 1990, BS 3958 and BS 6700: 1987, and guidance given in the BRE documents Thermal Insulation Avoiding Risks. Also

- all tanks should have appropriate fitting lids.
- cold water cisterns and tanks located 300mm or more above the ceiling joists shall be completely enclosed and insulated, with the insulation applied under the cold water cistern or tank.
- tanks located less than 300mm above the ceiling joists must be completely enclosed and insulated with the exception of the base

which must have no insulation. There must be no loft insulation at ceiling level immediately beneath the tank. Loft insulation should be turned up to surround the gap below the tanks up to a height of at least 300mm so that there is a continuous barrier around this area.

Code 1: YES

All of the exposed tanks and pipes in the loft space belonging to the surveyed dwelling are satisfactorily insulated (i.e. they meet the above standard)

Code 2: NO

The exposed tanks and pipes in roof/loft space are not satisfactorily insulated (i.e. they do NOT meet all of the above standard)

Code 3: NO INSULATION

There are exposed tanks and pipes in the loft space but in the loft space, but they are completely uninsulated (i.e. none of the exposed tanks and pipes in the loft space have any insulation at all).

Code 4: NO COLD WATER PIPES/TANK IN LOFT

A dry loft – common in modern dwellings with a combi boiler

Code 8: NOT APPLICABLE (NO LOFT)

The tanks and pipes belonging to the selected dwelling are not located within the roof/ loft space belonging to the surveyed dwelling, or there is no heat loss roof (e.g. a mid-floor or ground floor flat).

Code 9: UNOBTAINABLE

You are unable to gain access to the roof/loft space.

Section N. Dwelling measurements for energy assessment

Introduction

The survey form requires the floor area, heat loss perimeter and storey height of the main house for each storey of the dwelling, and that of an extension and non-separated conservatory. The floor area and the heat loss perimeters may be calculated from either external or internal measurements of the dwelling – there is a box to record whether you are using internal or external dimensions on the survey form. **You can change between internal and external when calculating the different floor areas and perimeters of the dwelling. HOWEVER, do not mix internal and external measurements within the same storey.**

NOTE: Storey heights and room in the roof floor areas are ALWAYS INTERNAL measurements.

The measurement of floor areas, floor to ceiling heights, and the heat loss perimeters is used to improve the accuracy of the energy calculations by deriving the heat loss envelope of the dwelling. Where external dimensions are surveyed, the program subtracts the thickness of the external walls to calculate the internal dimensions.

Surveyors may use either a 2m Surveyors Rod or tape measure to collect these measurements.

NOTE: A digital tape measure is NOT to be used unless it is a laser measurement device (e.g. Leica Disto range and the Bosch Laser Rangefinder range and Stanley TruLaser range). Please ensure that the device uses the laser to measure the distance. There are devices that have a laser light attached to a sonic measurement system that are not to be used.

Floor Area Measurements

All measurements are to be made to the nearest 0.1 of a metre with the resulting floor areas rounded to the nearest whole number. Working space for you to draw sketches of floor plans, write measurements and make calculations is provided below question N9.

For the measurement of floor areas, you should **include** habitable area of the dwelling:

- Rooms (for a definition refer to Section 3);
- Bathrooms, toilets and closets;
- Stairs, halls, landings or other circulation spaces;
- Utility rooms, store rooms and cupboards that can be entered from within the habitable dwelling;

- Fitted cupboards that can be entered from within the habitable dwelling;
- Large bay windows, if they are more than 10% of the floor area;
- Porches without a separating door and heated porches.

You should **ignore**:

- Small bays;
- Oriel windows;
- Cupboards built into the thickness of walls;
- Chimney breasts;
- Entrance doors that are recessed from the building line;
- Separated and unheated Porches;
- Separated conservatories.

The habitable floor area for each storey of the dwelling should be assessed. For the definition of **habitable floor** refer to questions J1 and J2.

The floor area for basements is to be measured if the basement contains habitable rooms. Refer to J4 – if there are **NO** habitable rooms in the basement then do not measure the basement floor area, and the floor above the basement is the Ground floor of the dwelling (and it will be suspended). If there are habitable rooms in the basement, then the basement becomes the Ground floor of the dwelling.

Measurement Type

For each floor measured you are required to state if the floor area calculation was based on external or internal measurements.

EXTERNAL MEASUREMENTS

The calculation of the appropriate floor area was calculated solely using external measurements.

INTERNAL MEASUREMENTS

The calculation of the appropriate floor area was calculated using on internal measurements.

NOTE: Do not mix internal and external measurements within a floor area.

Floor to Ceiling Height Measurements

You should measure the vertical distance between the floor and the underside of the ceiling to the nearest 0.1 of a metre for each applicable habitable floor.

Do **NOT** assume that the height of upper floors will be the same as the ground / lower floor.

For pitched and coombe (sloping) ceilings the floor to ceiling height should be measured as the distance between the floor and the mid point of the sloping part of the ceiling.

For questions N1 to N7, **Not Applicable** and **Unobtainable** have the following codes where applicable:

	Area (m ²)	Measurement Type	Height (m)	Exposed Perimeter (m)	Floor construction	Floor Insulation
Not Applicable	888	8	8.8	888	8	8
Unobtainable	999	9	9.9	999	9	9

NOTE: The row for N1 must always be completed in its entirety. In N2 to N7, where the area is entered as either 888 or 999 then a squiggly line can be drawn through the rest of the row (see below).

Exposed Perimeters

The exposed (heat loss) perimeter of the dwelling and that of any extension and non-separated conservatory are to be entered (separately) on the survey form. Where there is an integral garage, or an adjoining garage, the perimeter of the house next to the garage is counted as part of the exposed perimeter. In flats, unheated access corridor, a wall backing on to the stairwell, lift shaft or other unheated space (e.g. an externally vented drying room) are all to be counted as part of the

Extensions

An extension is **any part of habitable dwelling the house that has a different insulation standard or different thermal characteristics (wall, roof, or floor) from the rest of the house**. This will normally be because it has been built at a different time. However, it could be part of the original dwelling was constructed in different materials, or that an occupant has insulated part of a house (as opposed to the whole property). Distinguishing between the main part of the house and an extension allows the effect of different levels of insulation to the walls or loft/roof to be accurately calculated in the program. For instance, if a house has a pitched main roof, and part flat roof, this should be entered as a main house plus an extension even if the roofs were built at the same time.

You do not count as extensions parts of the building that have the same wall and roof construction, levels of insulation, and are built within the same age band as the main dwelling (even if they are not built in the same year.)

The age, wall construction and insulation, the roof construction and insulation, and the floor construction and insulation for the extension are entered onto the survey form separately from the main part of the house, and there are appropriate sections of the form for doing this.

For the purpose of the survey, there are two types of extension. Horizontal extensions that lose heat to the outside through the walls and **both** the roof and the floor. Vertical extensions lose through the walls and **either** the roof or the floor. **Further details are provided on Appendix 4: Guidance on scoring extensions.** Note that this also provides guidance on how to score two-storey extensions.

Surveyors need to be aware that if the date of construction is the same but there are two different construction characteristics then this should be recorded in Section Q as Principal/Secondary External Construction/Materials.

Conservatories

A conservatory is an extension **with at least three-quarters of its roof and at least half its external walls made of glass or a translucent material.** For the purposes of the measurements, **ONLY** conservatories that are **NOT THERMALLY SEPARATED** from the main dwelling need to be measured, whether they have installed heating or not.

Conservatories provide shelter to the external wall, and also capture solar heat, which can be used to partially warm the house. The ethos underlying RdSAP is that these benefits will be generally offset by extra energy consumption associated with the household using the conservatory, so the net effect either way is very small, and therefore, a thermally separated conservatory can be ignored. **If the conservatory is thermally separated from the dwelling, then it is not included in the measurements,** even though you will have identified a conservatory as being present, either code 3 or code 4 at D6).

To qualify as thermally separated from the dwelling, the conservatory must be able to be closed off from the dwelling. In addition the U-values of the walls, windows and doors between the dwelling and the conservatory must be comparable to the exposed elements of the dwelling (formally, the U-values of the separating components are no more than 10% greater than those of the heat loss elements of the main dwelling). An archway instead of a door from the house into the conservatory obviously means that the heat from the house will be lost through the conservatory, and therefore is NOT thermally separated and therefore needs to be measured.

If the conservatory is not thermally separated, then you will measure the area and perimeter of the conservatory so that the program can estimate the area of glazing and calculate its heat losses, as well as the heat gains from the sun during the heating season.

N1. Ground/lowest floor

The ground or lowest floor details of the dwelling is normally the level entered directly from the garden or communal staircase / landing.

If a habitable basement is present (see J4) the area of the habitable basement, heat loss perimeter, and floor to ceiling height are entered in N1.

For intermediate (mezzanine) floors the area of the mezzanine level should be included with the area of the nearest principal floor. Where the intermediate floor is equidistant between two floors it should be recorded with the upper floor.

N2. First floor

The floor details for the level above that recorded for N1.

N3. Second floor

The floor details for the level above that recorded for N2.

N4. Third floor and above

The floor details for the level above that recorded for N3.

Where there are more than three habitable floors present in the dwelling, you should enter the sum of the third floor area **together** with all higher habitable floor areas.

N5. Rooms in roof

Only the INTERNAL floor area is needed for rooms in the roof.

N6. Extension 1*

The floor details for extension 1. Please indicate if this is a conservatory.

N7. Extension 2*

The floor details for extension 1. Please indicate if this is a conservatory.

FLOOR CONSTRUCTION**Code 1: Solid**

The ground floor is solid, i.e. it is sitting directly on soil and not above a solum (e.g. solid concrete slab). There will be no air vents under the floor.

Code 2: Suspended (not timber)

The ground floor is suspended, i.e. it is sitting above a solum, but it is not a timber floor construction (e.g. suspended concrete slab, block and beam floor). There are usually air bricks to vent the solum.

This floor description may also apply to upper floor flats with exposed or semi-exposed floors. The upper exposed or semi-exposed floor is NOT a timber construction.

Code 3: Suspended timber

The ground floor is suspended, i.e. it is sitting above a solum, AND it is a timber floor construction. There should be air bricks to vent the solum.

This floor description may also apply to upper floor flats with exposed or semi-exposed floors. The upper exposed or semi-exposed floor is NOT a timber construction.

NOTE: Where there are both solid and suspended timber floors present (e.g. the kitchen is a solid floor (e.g. quarry tiles or a concrete slab) and the rest of the ground floor is suspended timber, which is not uncommon in inter-war dwellings), if the second floor type is less than 10% of the total floor area it can be ignored. If it is more than 10% of the total floor area then it is thermally different and should be entered as an extension.

Code 8: Not applicable

The dwelling does not have a ground or upper heat loss floor (e.g. it is an upper floor flat with NO heat loss floor).

Code 9: Unobtainable

FLOOR INSULATION

As this is a non-intrusive survey, both the NHER and RdSAP programs default to the level of insulation that was required by the prevailing Building Regulations covering the construction of the dwelling. Dwellings built up to 1991 are presumed to have no insulation installed in the floor; dwellings built after 1992 are presumed to meet the respective increases in the insulation standards since then. So selecting Code 1 (as built) and Code 9 (unobtainable) here will result in the same default being applied, which will be determined by the NHER dwelling age selected at M1. The only time the default insulation values will not be used is when the surveyor indicates insulation has been added to the floor since its original construction (i.e. insulation has been retro-fitted to the dwelling). As this is a non-intrusive survey, it is going to be rare that you will be able to confirm the addition of this extra insulation without getting documentation from the householder.

Code 1: As built

NO additional insulation has been added to the floor since its original construction.

Code 2: Retro-fitted

Additional insulation HAS been added to the floor since its original construction.

Code 9: Unobtainable

It has not been possible to assess whether additional insulation has been added to the floor since its original construction. As we ask you not to guess at insulation levels, this is likely to be the most common response.

Worked examples for section N

Eleven worked examples are given in Figures N1 – N8 below.

Figure N1 2-storey semi detached dwelling with integral garage on ground floor

Figure N2 2-storey detached dwelling with single storey extension

Figure N3 2-storey detached dwelling with single storey extension over attached garage

Figure N4a bungalow with non-thermally separated conservatory

Figure N4b bungalow with thermally separated conservatory

Figure N5a 2-storey detached house with non-thermally separated conservatory and attached garage

Figure N5b 2-storey detached house with thermally separated conservatory and attached garage

Figure N6a 2-storey mid terraced house with non-thermally separated conservatory and extension

Figure N6b 2-storey mid terraced house with thermally separated conservatory and extension

Figure N7 ground floor flat

Figure N8 2-storey upper floor deck access flat

In each of these examples we are assuming:

floor to ceiling height is 2.4m

all the measurements are internal

The rest of the information needed to fill in Section N is given on the page.

Figure N1: Areas and perimeters for two storey semi detached house with integral garage on ground floor (first floor extends over the garage). Ground floor = suspended timber.

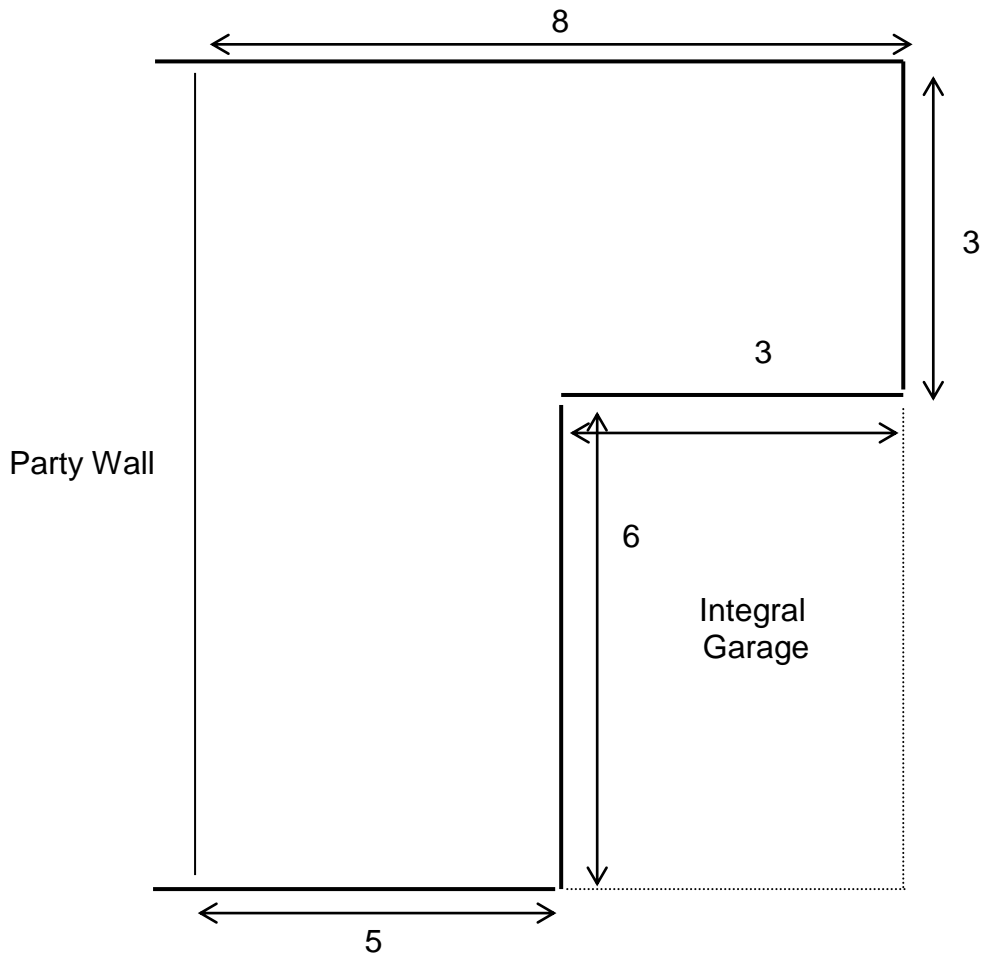

Ground floor area is $(8 \times 3) + (6 \times 5) = 54\text{m}^2$

First floor area is $(8 \times 9) = 72\text{m}^2$

House exposed ground floor perimeter = $8 + 3 + 3 + 6 + 5 = 25\text{m}$ (includes edge to the garage)

House exposed first floor perimeter = $8 + 9 + 8 = 25\text{m}$

	Area (m ²)	Measurement Type	Height (m)	Exposed Perimeter (m)	Floor construction	Floor Insulation	Enter 1 if conservatory
Ground / lowest floor	54	2	2.4	25	3	9	
First / Next floor	72	2	2.4	25	8	8	
Extension 1	888	8	8.8	8	8	8	
Extension 2	888	8	8.8	8	8	8	

Figure N2: Areas and perimeters for two storey detached house with single storey extension; First floor is the same dimensions as the Main House on Ground Floor. Ground Floor for main house is suspended timber and for the extension solid concrete.

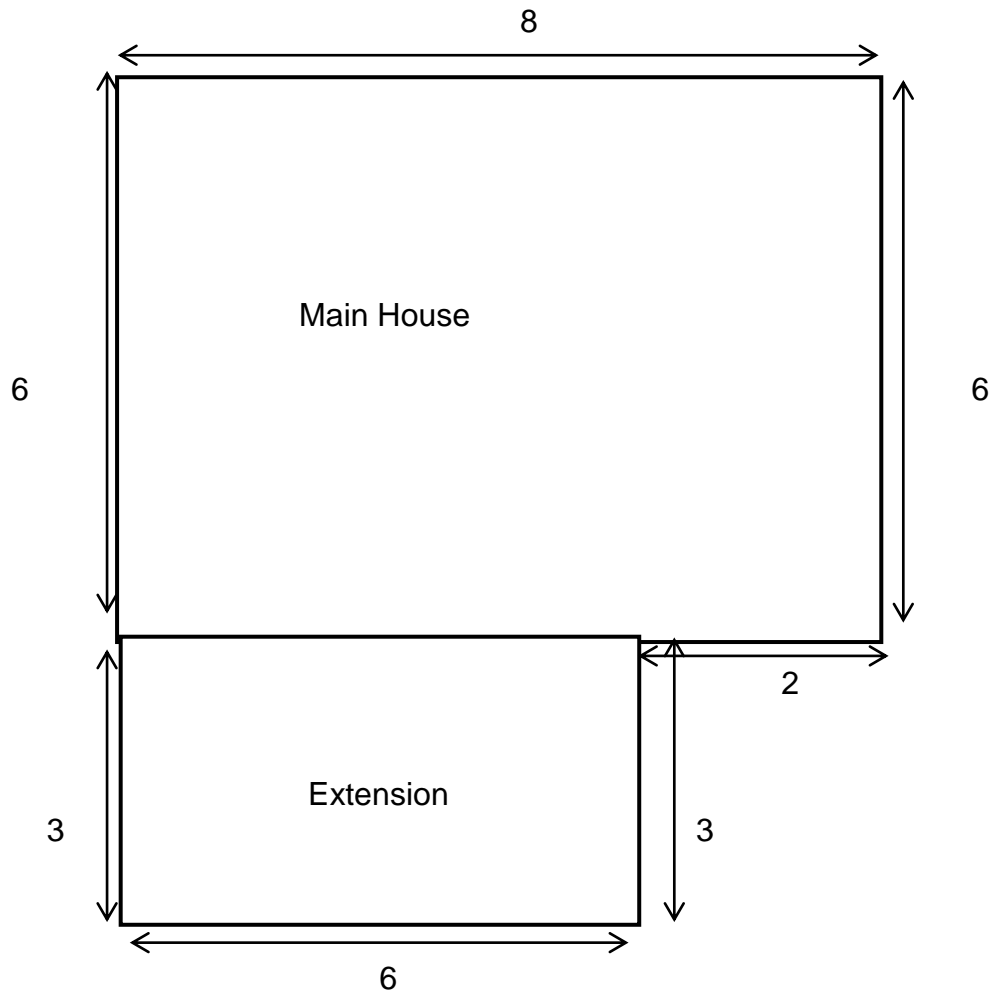

Ground floor area is $(8 \times 6) = 48\text{m}^2$

First floor area is $(8 \times 6) = 48\text{m}^2$

Extension 1 area is $(6 \times 3) = 18\text{m}^2$

House ground floor exposed perimeter = $6 + 8 + 6 + 2 = 22\text{m}$ (excludes wall length between main house and the extension)

House first floor perimeter = $8 + 6 + 8 + 6 = 28\text{m}$

Extension 1 perimeter = $3 + 6 + 3 = 12\text{m}$

	Area (m ²)	Measurement Type	Height (m)	Exposed Perimeter (m)	Floor construction	Floor Insulation	Enter 1 if conservatory
Ground / lowest floor	48	2	2.4	22	3	9	
First / Next floor	48	2	2.4	28	8	8	
Extension 1	18	2	2.4	12	1	9	
Extension 2	888	8	8.8	8	8	8	

Figure N3: Areas and perimeters for two storey detached house with extension over garage. The floor over the garage a semi-exposed timber floor

Ground Floor Plan

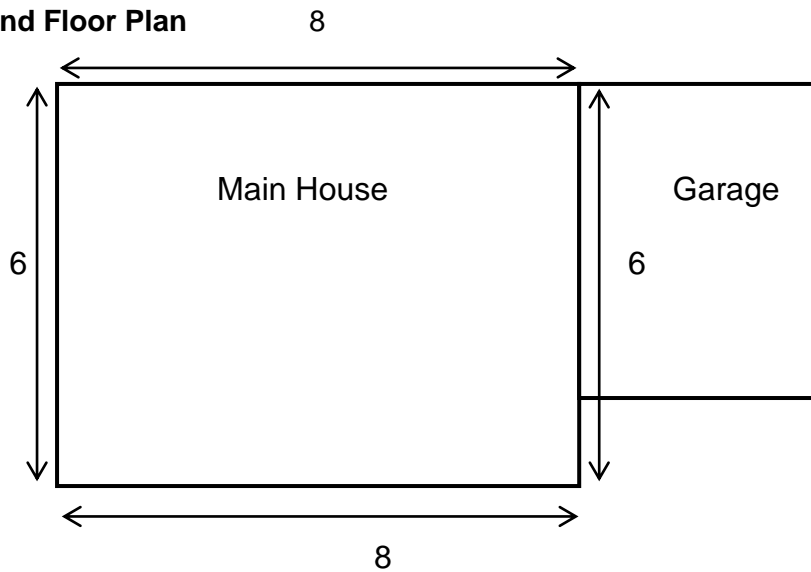

First Floor Plan

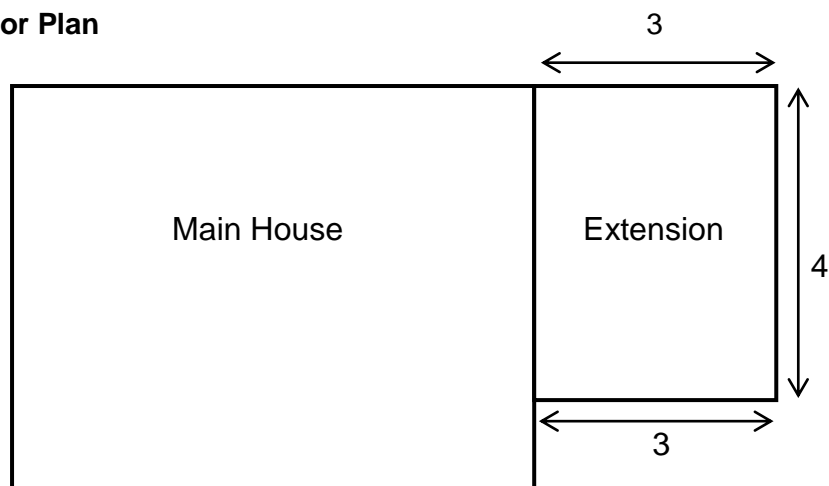

Ground floor area is $(8 \times 6) = 48\text{m}^2$

Ground floor exposed perimeter = $6 + 8 + 6 + 8 = 28\text{m}$ (includes edge to the garage)

First floor area is $(8 \times 6) = 48\text{m}^2$

First floor exposed perimeter = $8 + 6 + 8 + 2 = 24\text{m}$

Extension 1 floor area is $(4 \times 3) = 12\text{m}^2$

Extension 1 exposed perimeter = $3 + 4 + 3 = 10\text{m}$

	Area (m ²)	Measurement Type	Height (m)	Exposed Perimeter (m)	Floor construction	Floor Insulation	Enter 1 if conservatory
Ground / lowest floor	48	2	2.4	28	3	9	
First / Next floor	48	2	2.4	24	8	8	
Extension 1	12	2	2.4	10	3	9	
Extension 2	888	8	8.8	8	8	8	

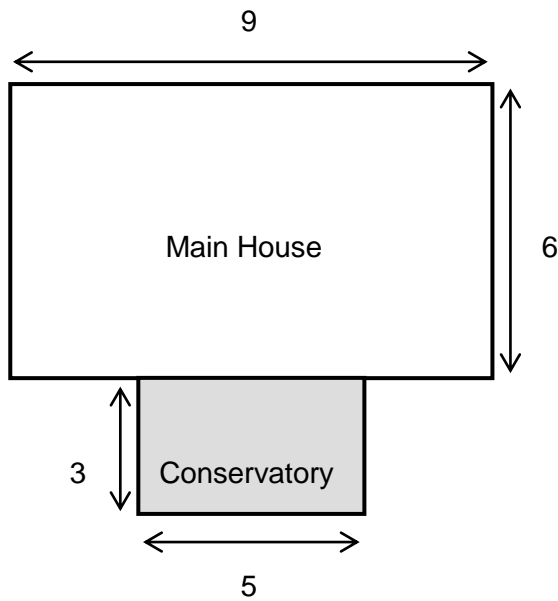
Figure N4a: Bungalow with a solid concrete floor a non-thermally separated conservatory

Ground floor area is $(9 \times 6) = 54\text{m}^2$

House perimeter = $6 + 6 + 9 + 4 = 25\text{m}$ (excludes wall length between main house & conservatory)

Conservatory floor area is $(5 \times 3) = 15\text{m}^2$

Conservatory perimeter $3 + 5 + 3 = 11\text{m}$

	Area (m ²)	Measurement Type	Height (m)	Exposed Perimeter (m)	Floor construction	Floor Insulation	Enter 1 if conservatory
Ground / lowest floor	54	2	2.4	25	1	9	
First / Next floor	888	8	8.8	88	8	8	
Extension 1	15	2	2.4	11	1	9	1

Figure N4b: Bungalow with a solid concrete floor a thermally separated conservatory

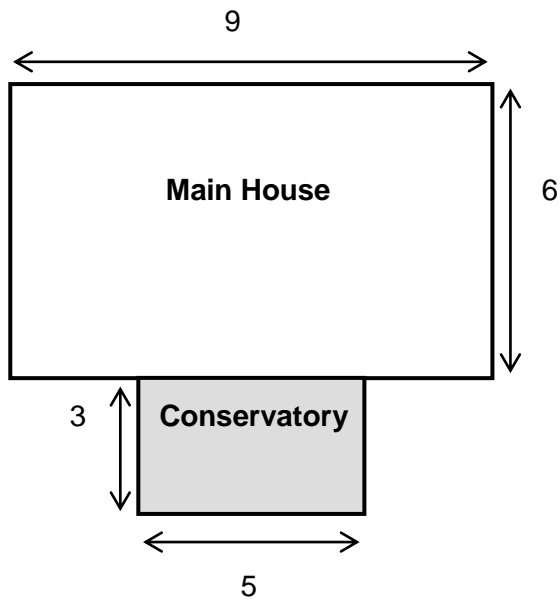

Ground floor area is $(9 \times 6) = 54 \text{ m}^2$

House perimeter = $6 + 6 + 9 + 9 = 30\text{m}$ (includes wall length between main house & conservatory)

Conservatory floor area ignored

Conservatory perimeter ignored

	Area (m ²)	Measurement Type	Height (m)	Exposed Perimeter (m)	Floor construction	Floor Insulation	Enter 1 if conservatory
Ground / lowest floor	54	2	2.4	0	1	9	
First / Next floor	888	8	8.8	88	8	8	
Extension 1	888	8	8.8	88	8	8	

Figure N5a: Two storey detached house with a suspended timber and a non-thermally separated conservatory with a concrete floor.

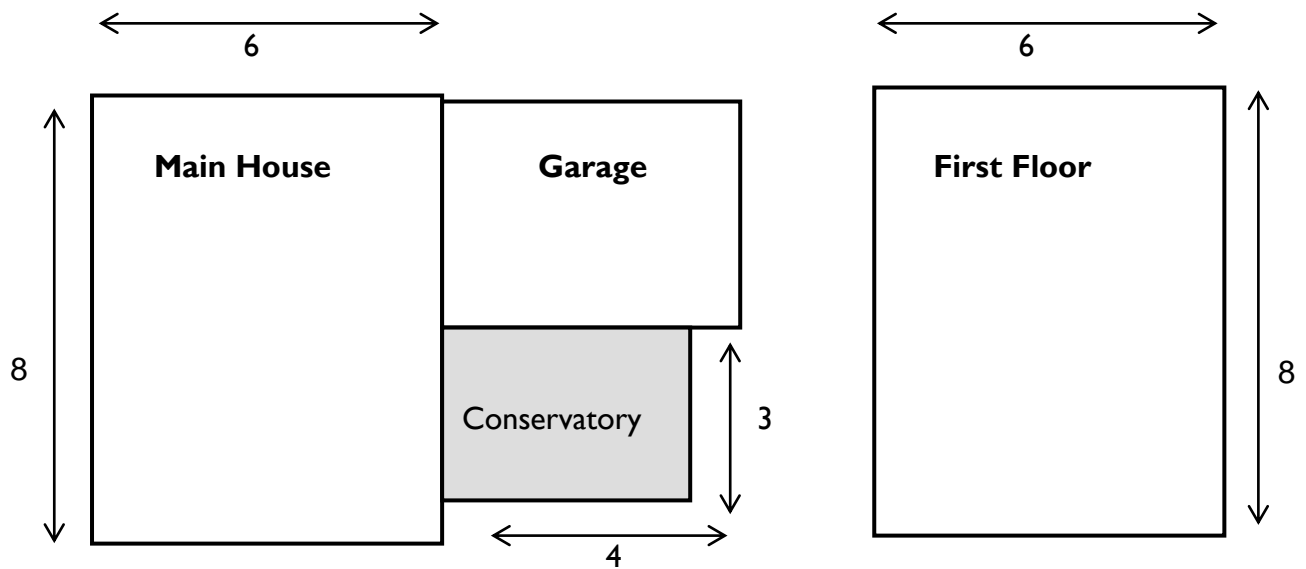

Ground floor area is $(8 \times 6) = 48\text{m}^2$

First floor area is $(8 \times 6) = 48\text{m}^2$

Ground Floor perimeter = $6+8+6+5= 25\text{m}$ (excludes wall length between main house & conservatory)

First Floor perimeter = $6+8+6+8= 28\text{m}$

Conservatory floor area is $(4 \times 3) = 12\text{m}^2$

Conservatory perimeter is $4 + 3 + 4 = 11 \text{ m}$ (includes wall length to garage)

	Area (m ²)	Measurement Type	Height (m)	Exposed Perimeter (m)	Floor construction	Floor Insulation	Enter 1 if conservatory
Ground / lowest floor	48	2	2.4	25	3	9	
First / Next floor	48	2	2.4	28	8	8	
Extension 1	12	2	2.4	12	1	9	1

Figure N5b: Two storey detached house with a suspended timber and a thermally separated conservatory with a concrete floor.

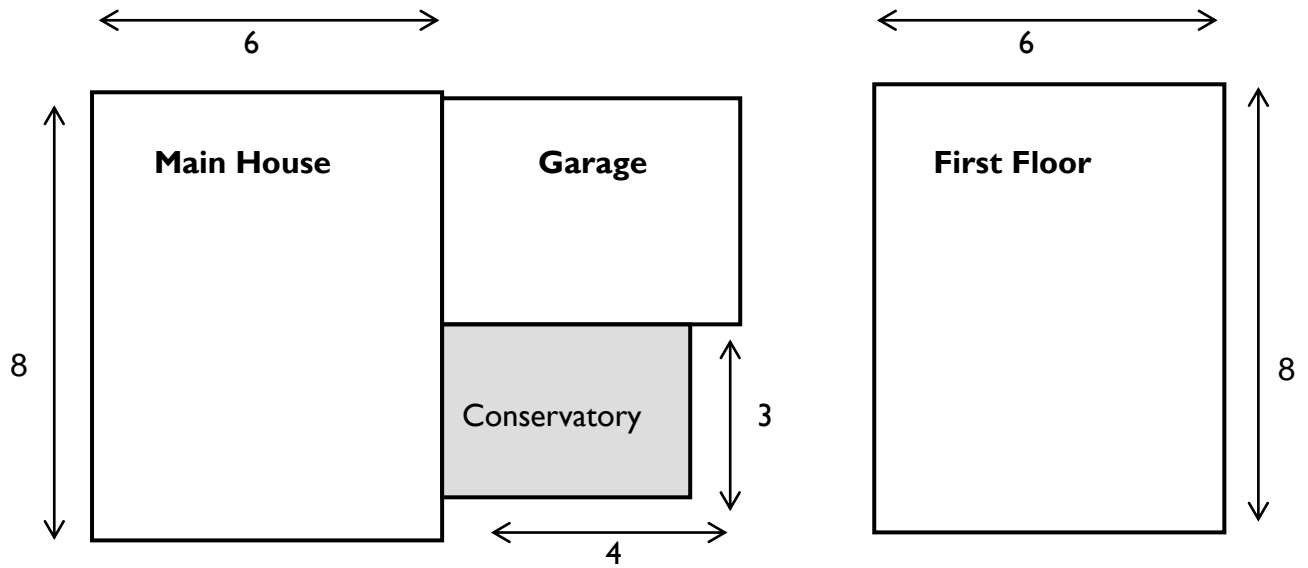

Ground floor area is $(8 \times 6) = 48\text{m}^2$

First floor area is $(8 \times 6) = 48\text{m}^2$

Ground Floor perimeter = $6+8+6+8= 28\text{m}$ (*ignores garage and conservatory*)

First Floor perimeter = $6+8+6+8= 28\text{m}$

Conservatory floor area ignored

Conservatory perimeter ignored

	Area (m ²)	Measurement Type	Height (m)	Exposed Perimeter (m)	Floor construction	Floor Insulation	Enter 1 if conservatory
Ground / lowest floor	48	2	2.4	28	3	9	
First / Next floor	48	2	2.4	28	8	8	
Extension 1	888	8	8.8	88	8	8	

Figure N6a: Two storey mid terrace house with a suspended timber and a non-thermally separated conservatory with a concrete floor. First Floor same dimensions as Main House. Extension is single storey with suspended timber floor

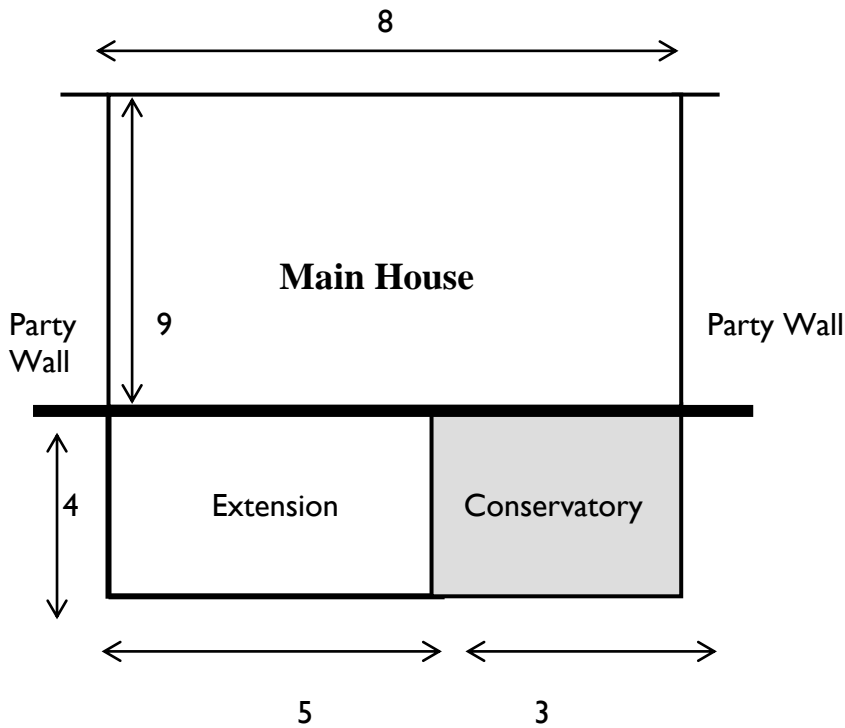

Ground floor area is $(8 \times 9) = 72\text{m}^2$

First floor area is $(8 \times 9) = 72\text{m}^2$

Ground Floor perimeter = 8m (*excludes party walls and wall to extension and conservatory*)

First Floor perimeter = $8 + 8 = 16\text{m}$ (*excludes part wall*)

Extension 1 floor area is $(4 \times 5) = 20\text{m}^2$

Extension 1 perimeter = $4 + 5 = 9\text{m}$

Conservatory floor area is $(4 \times 3) = 12\text{m}^2$

Conservatory perimeter is $4 + 3 = 7\text{m}$ (*excludes wall to extension*)

	Area (m ²)	Measurement Type	Height (m)	Exposed Perimeter (m)	Floor construction	Floor Insulation	Enter 1 if conservatory
Ground / lowest floor	72	2	2.4	8	3	9	
First / Next floor	72	2	2.4	16	8	8	
Extension 1	20	2	2.4	9	3	9	
Extension 2	12	2	2.4	7	1	9	1

Figure N6b: Two storey mid terrace house with a suspended timber and a thermally separated conservatory with a concrete floor. First Floor same dimensions as Main House. Extension is single storey with suspended timber floor.

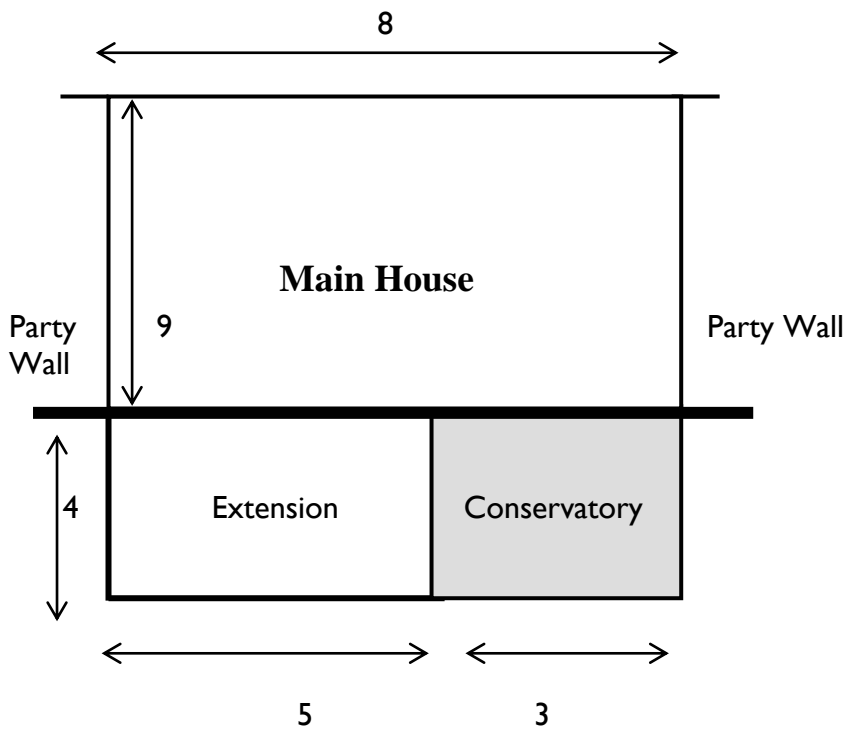

Ground floor area is $(8 \times 9) = 72\text{m}^2$

First floor area is $(8 \times 9) = 72\text{m}^2$

Ground Floor perimeter = $8 + 3 = 11\text{m}$ (excludes party walls and wall to extension, includes wall to conservatory)

First Floor perimeter = $8 + 8 = 16\text{m}$ (excludes party wall)

Extension 1 floor area is $(4 \times 5) = 20\text{m}^2$

Extension 1 perimeter = $4 + 5 + 4 = 13\text{m}$

Conservatory floor area ignored

Conservatory perimeter ignored

	Area (m ²)	Measurement Type	Height (m)	Exposed Perimeter (m)	Floor construction	Floor Insulation	Enter 1 if conservatory
Ground / lowest floor	72	2	2.4	11	3	9	
First / Next floor	72	2	2.4	16	8	8	
Extension 1	20	2	2.4	13	3	9	
Extension 2	888	8	8.8	8	8	8	

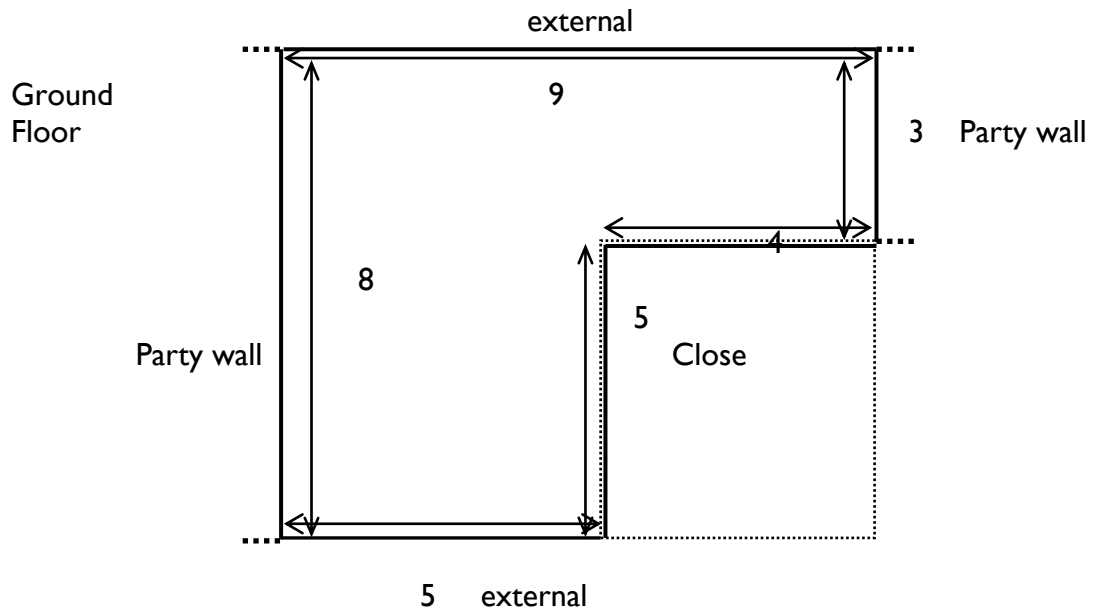
Figure N7: Ground Floor Flat with solid concrete floor

Ground Floor Area is $(9 \times 3) + (5 \times 5) = 52\text{m}^2$

Lowest Floor Exposed External Perimeter is $9 + 5 + 5 + 4 = 23\text{m}$ (two walls to Close included; party walls ignored)

	Area (m ²)	Measurement Type	Height (m)	Exposed Perimeter (m)	Floor construction	Floor Insulation	Enter 1 if conservatory
Ground / lowest floor	52	2	2.4	23	1	9	
First / Next floor	888	8	8.8	8	8	8	
Extension 1	888	8	8.8	8	8	8	
Extension 2	888	8	8.8	8	8	8	

Figure N8: Two-storey terraced, top floor Deck Access Maisonette, concrete floors

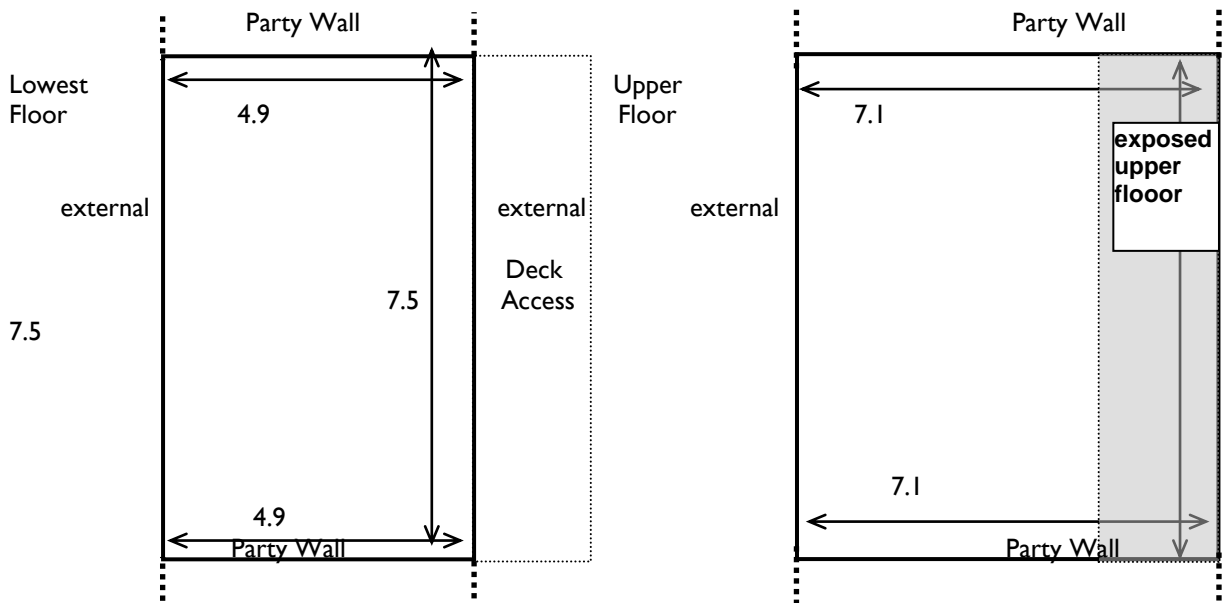

Lowest Floor Total Floor Area is $(4.9 \times 7.5) = 36.75\text{m}^2$ (which rounds to 37m^2)

Lowest Floor External Exposed Perimeter = $7.5 + 7.5 = 15\text{m}$ (2 party walls ignored)

Next Floor Total Floor Area is $(7.1 \times 7.5) = 53.25\text{m}^2$ (which rounds to 53m^2)

Next Floor External Exposed Perimeter = $7.5 + 7.5 = 15\text{m}$ (2 party walls ignored)

	Area (m ²)	Measurement Type	Height (m)	Exposed Perimeter (m)	Floor construction	Floor Insulation	Enter 1 if conservatory
Ground / lowest floor	37	2	2.4	15	8	8	
First / Next floor	53	2	2.4	15	1	9	
Extension 1	888	8	8.8	8	8	8	
Extension 2	888	8	8.8	8	8	8	

Section O. Characteristics of common elements

Questions in this section deal with the data for the block with some form of common access. Question O1 must be completed even if the dwelling is not part of a block with common access.

O1. Is the dwelling part of a block with common access?

NOTE: SEE DIAGRAM O1 - COMMON ACCESS TO BLOCK

Common access occurs where two or more flats within a block share either:
a common entrance, with or without stair access; or
an external staircase.

The presence of flats within the block that have their own independent access does not prevent the block being classified as a block with common access.

The sharing of footpaths and external steps at ground level is excluded from this assessment.

You should refer back to the Type of Flat at C2:

If C2 is coded:

as a **tenement** (code 1) or **tower/slab** (code 3) - surveyors will be filling in Section O and P;

as a **4-in-block** (code 2) or **not a flat** (code 8) - surveyors will code 2 at O1 and skip rest of Section O and P

as a **conversion from a house** – surveyors will have to determine whether there is a shared common access and score O and P.

Code 1: YES

The selected dwelling is located within a block that has common access.

The selected dwelling need not itself be entered from the common access but it must form part of a block in which common access exists for two or more flats.

Where you record Code 1 Sections O and P should be completed.

Code 2: NO

The selected dwelling is not located within a block that has common access. It is either a house or a flat within a block, each with its own independent access (4-in-a-block type and some conversions).

Where you record Code 2, you should leave Sections O and P blank and proceed to Section Q.

1. Diagram O1

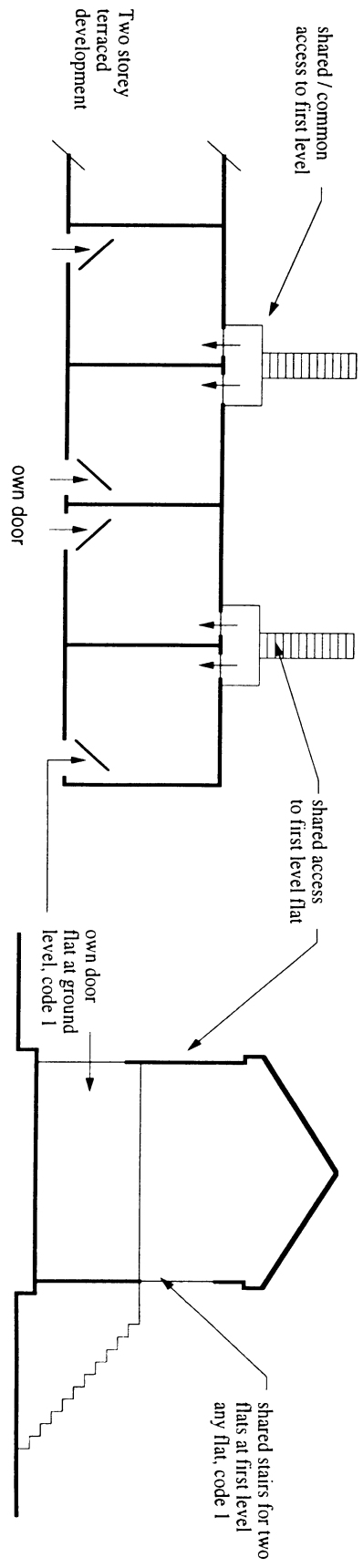
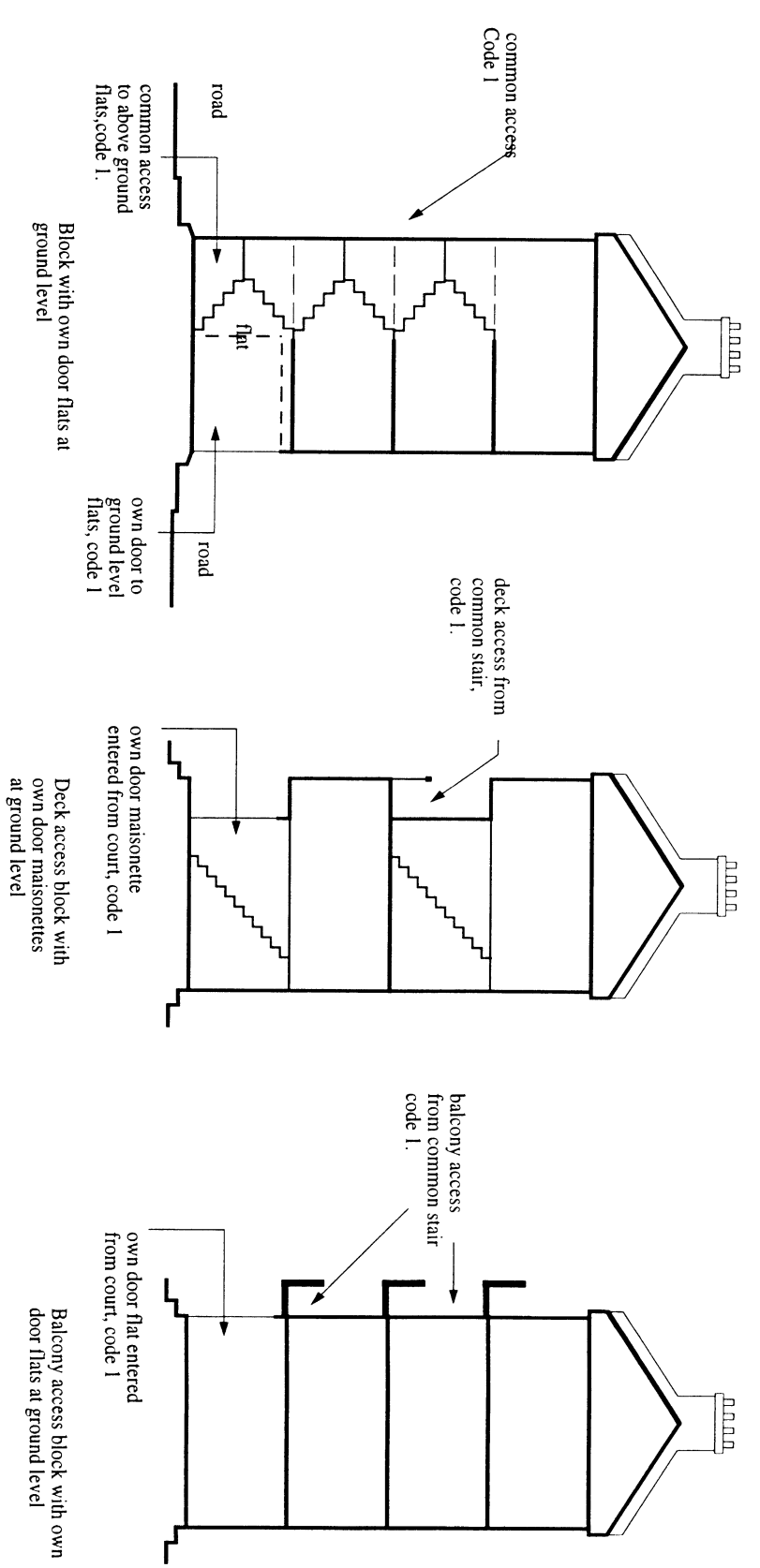

O2. Type of common access in the block

NOTE: SEE DIAGRAM O2 - TYPE OF COMMON ACCESS TO BLOCK

You should record the **predominant** type of common access within the block.

Where the **flat** being surveyed has its own **independent access** but is part of a block that contains flats that have shared access **it is the type of shared access that should be recorded** here, not the access to the flat being surveyed.

Code 2: LANDING

This is generally with a tenement at C2 but can be tower/slab type if more than ten storeys.

The entrance doors to two or more flats are from a shared stair and landing. Where single flats are served by their own stair, from a common hall or passageway they should also be recorded here.

This classification will largely consist of traditional “walk-up” closes.

For the purposes of this survey landings can contain up to and including six flats. Where more than six flats are accessed from a level it is classified as a passage (Code 3) - see below.

Code 3: PASSAGE

This can be associated with a tenement or tower/slab type flat.

The entrance doors to seven or more flats are from internal corridors or internal passageways.

This classification encompasses traditional “walk-up” closes and multi-storey flats where the number of doors accessed from the landing is greater than six.

Code 4: DECK

This is always associated with a Tower/Slab classification at C2. Deck access comprises flats with habitable rooms above or below access walk ways.

Code 5: BALCONY

This is always associated with a Tower/Slab classification at C2. Balcony access comprises walkways that project beyond the main face of the block and which are not contained within the main roof line.

Code 6: GALLERY

This is always associated with a Tower/Slab classification at C2. Gallery access comprises walkways that are usually open (to the air) contained within the main roof line of the block.

Code 7: OTHER

Code 7 (Other) should be used for flats that are entered directly from a lift hall (usually towers). There will almost always be a stair associated

with the lift. This stair should be included when assessing the common access unless it is an external fire escape stair.

The code should also be used for ground only access flat. These are not own door flats within the common block. The common access is only on the ground floor. Upper storey flats have their own individual stairs (as 4-in-block type) and are generally external. These are very rare.

NOTE: Surveyors cannot classify the common access into any of the preceding categories (Codes 2 - 7) should contact their Regional Manager.

1. DIAGRAM O2

Tower block with lift hall, Code 7

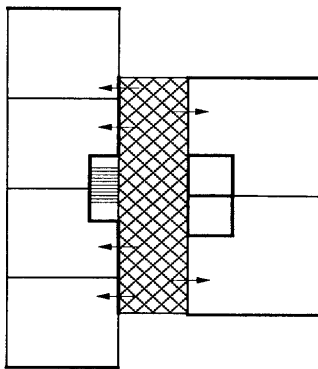

Slab block with corridor / passage access, Code 3

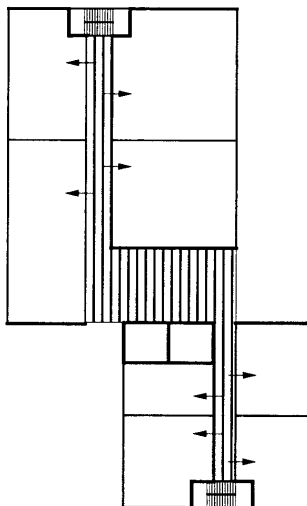

Corridor / passage access, Code 3

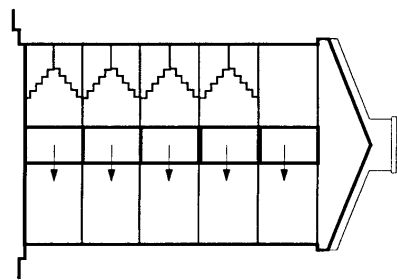

Deck-access over room, Code 4

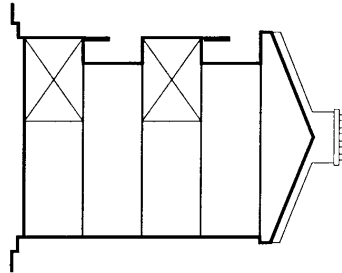

Projecting balcony, code 5

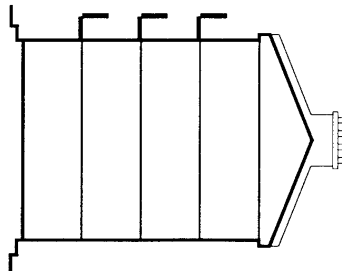

Gallery under roof, Code 6

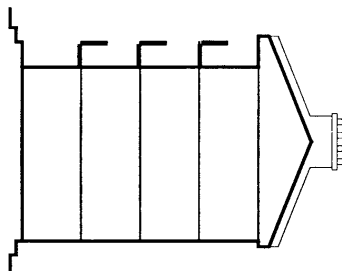

O3. Number of staircases in the block

NOTE: The repair assessment at P1 is based upon the number of stairs recorded here.

SPECIFY: **Specify the number of common staircases associated with the common block.**

Include any staircases used when lifts are out of order.

NOTE: **Do not include fire escape stairs within this assessment.**

Fire escape stairs are those that have escape from fire as their primary purpose (often external metal stairs). Stairs that may form part of an escape route but which are also used for other purposes are to be included.

Code 8: NO STAIRCASES

There are no staircases within the block.

Code 9: UNOBTAINABLE

You are unable to determine if there are any staircases within the block.

O4. Number of domestic lifts in the block

The repair assessment at P7 is based upon the number of lifts recorded here.

SPECIFY: **Specify here the number of passenger car lifts in the block.**

Code 8: NO LIFTS

There are no lifts within the block.

Code 9: UNOBTAINABLE

You are unable to determine if there are any lifts within the block.

O5. Are domestic lifts suitable for wheelchair users?

This question is designed to establish if lifts within the block are suitable for independent use by wheelchair users.

In order for a lift to be suitable for this type of use it must satisfy the following criteria:

the doors must be a minimum of 800 mm wide;

the internal dimensions of the passenger car must be a minimum of 1400 mm deep and 1100 mm wide;

lift controls, both in the hallway and inside the passenger car, must be reachable by a wheelchair user. This requires controls to be:

- a maximum of 1200 mm above ground level; and
- at least 400 mm in from the front wall of the passenger car.
- lift doors must remain open for at least 5 seconds; and

- the landings from which the lift is entered should allow sufficient space (at least 1.5 metres square) for a wheelchair user to manoeuvre.

Code 1: NO

The lift, its controls and/or the landings from which it is entered do not satisfy all of the above requirements.

Code 2: YES

The lift, its controls and the landings from which it is entered satisfy all of the above requirements.

Code 8: N/A - NO LIFTS

There are no lifts within the block as indicated at O4.

Code 9: UNOBTAINABLE

You are unable to determine if any lifts within the block are suitable for use by wheelchair users – indicated at O4

O6. Is the common circulation area barrier free?

The term 'Barrier Free' is taken to mean that a person in a wheelchair **[full or wheelchair barrier free]** or using a walking aid (Zimmer Frame etc.) **[ambulant barrier free]** has passed through a suitable entrance door to the common access area and is able to make their way to the entrance door to the survey dwelling within the block.

The question attempts to determine levels of barrier free access within the common access to the survey flat. This allows all flats within a common access block to be assessed on their own merit rather than assessing the block as a whole.

For instance: In a traditional walk-up close of six flats say - no lift. The two ground floor flats may be barrier free (either ambulant or full wheelchair) whereas the upper flats will almost certainly not be barrier free because of the stairs. We will then be able to estimate the number of ground floor flats with wheelchair or ambulant barrier freedom within this type of close.

Lifts are assessed in O5 above and do not need to be considered here.

The various levels of access within the block: are described below.

passages must be at least 900 mm wide free of obstruction **and**

doors must be at least 750 mm wide **and**

there are no more than two steps (over 20 mm) within the common circulation area being assessed.

The above will **satisfy** the **ambulant** barrier free **criteria**.

Wheelchair users find it extremely difficult to turn 90 degrees (a right angle) in a 900 mm wide passageway to enter a 750 mm wide door.

Therefore to be able to enter flats that require a 90 degrees turn:

the passageway must widen to at least 1200 mm opposite a 750 mm wide entrance doors to flats;

or

passages must be at least 900 mm wide free of obstruction and the entrance door to the flat must be at least 900 mm wide;

and

there are no changes in level greater than 20 mm within the common access area being assessed

The above will **satisfy** the **full** or wheelchair **barrier free criteria**.

For the purposes of this survey any change in level greater than 20 mm within the internal common circulation areas will render these areas unsuitable for Wheelchair Barrier Free access.

For ambulant barrier free access there should be no more than two such changes in level. Common circulation areas failing both these criteria should therefore be recorded using Code 1 (No).

This does not include the threshold to the entrance door which is recorded at **D4**.

In multi-storey blocks you should inspect the lift hall at the level of the selected dwelling along with the floor above and the floor below where these exist along with the entry level areas.

Code 1: NO

The common circulation access areas to the survey flat do not satisfy the above requirements and are therefore not barrier free.

Code 2: YES, ENTRY AMBULANT

Common circulation access areas to the survey flat satisfy the above requirements for ambulant disabled and so are barrier free for ambulant disabled.

Code 3: YES, FULL

Common circulation access areas to the survey flat satisfy the above requirements for wheelchair access and so are fully barrier free.

Code 9: UNOBTAINABLE

You are unable to determine if common circulation areas are Barrier Free.

<p>07. Is there an entry system?</p>

Code 1: YES, BELL TO EACH FLAT

Each flat within the block has its own doorbell located at the main entrance door to the block.

This will usually be connected to a door entry system but this is not a requirement of this answer category.

Unless there is obvious evidence to the contrary it should be assumed that the presence of a bell within the selected flat indicates that each flat within the block will have the same provision.

Code 2: YES, ENTRY PHONE

There is an entry phone system that allows the occupants of dwellings within the block to speak with someone at the main entrance door and remotely control their access.

Unless there is obvious evidence to the contrary it should be assumed that the presence of a hand set within the selected flat indicates that each flat within the block will have the same provision.

Code 3: YES, CONCIERGE

For the purposes of this survey it is assumed that blocks with a concierge will have either a bell or entry phone system to each flat. Code 3 (indicating the presence of a concierge) should therefore take precedence over Codes 1 or 2.

Code 4: NO

There is no communal entry system to the block or the provision of the communal entry system does not extend to every flat within the block.

Code 9: UNOBTAINABLE

You are unable to determine if there is a communal entry system to the block.

<p>O8. Is front access to common block secure?</p>

You should assess the front access door to the common block. Garden gates and side gates should be ignored.

Assess the adequacy of the locks regardless of their state of repair.

The requirements for adequate security are:

mortise locks;

rim type deadlock;

key operated multi-point lock;

electronic/magnetic locks.

You should not consider the number of levers present in mortise locks for this question.

Code 1: YES

Front access door has adequate lock.

Code 2: NO

Front access door does not have adequate lock.

Code 8: NOT APPLICABLE

No front door

Code 9: UNOBTAINABLE

You are unable to determine the front access door have adequate lock.

09. Is rear access to common block secure?

Restricted rear access to common closes (where present) discourages loitering, graffiti and burglaries.

You should assess the presence of locking devices on any rear common close door. This door often leads to a garden / bin stores and is not the main entrance to the common block.

Only the rear door to the common close should be assessed. Garden gates and the height of perimeter walls etc are to be ignored.

Any disrepair to the locks is to be ignored. Likewise you are not required to assess if any locks present are actually being used by the occupants.

The type of lock suitable is of a lesser criteria than those for the front access.

Adequate security is:

mortise locks;

rim type deadlock;

rim type mortise lock;

key operated multi-point lock;

electronic/magnetic locks;

yale lock;

one or more substantial bolts secured from the inside.

You should not consider the number of levers present in mortise locks for this question.

Code 1: YES

The rear access to the common block is secure.

Code 2: NO

There is rear access to the common block but it is not secure. (Either the door is not secure or there is no door present).

Code 8: NOT APPLICABLE

There is no rear access to the common block.

Code 9 UNOBTAINABLE

You are unable to establish if any rear access door to the common block is secure.

Section P. Repairs to common elements

You should undertake the following sequence in your inspection of the elements within the common access.

determine the whole extent of the element;

determine the presence of any disrepair;

assess the extent of that disrepair as a proportion of the whole element;

record the level of disrepair in the 10 point scale;

If there is disrepair... then consider if the action required to remedy any disrepair is urgent or non urgent

If there is no disrepair... then consider if the maintenance is urgent or normal.

Assess the residual life... of the element **after** any disrepair has been remedied or if there is no disrepair the residual life of the element.

NOTE: You are expected to inspect every floor within a walk up block.
In multi-storey blocks you should inspect the lift hall at the level of the selected dwelling along with the floor above and the floor below (where these exist).

REPAIR SCORES

Section P records the presence of disrepair to thirteen elements/groups of elements within the common access on an area or linear basis on the day of the survey (do not anticipate future disrepair). Any disrepair to an element, or group of elements, is to be considered in terms of a percentage of the total amount of that element present within the common access.

The evaluation and recording of repair scores follows the same methodology used in Section G (Room Repairs). Therefore:

Code "00" represents an element(s) in good repair requiring no remedial work;

Code "55" covers repairs less than 5%;

Code "01" covers repairs in the range 5% to less than 15%;

Code "02" covers repairs in the range 15% to less than 25%;

Code "03" covers repairs in the range 25% to less than 35%;

Code "04" covers repairs in the range 35% to less than 45%;

Code "05" covers repairs in the range 45% to less than 55%;

Code "06" covers repairs in the range 55% to less than 65%;

- Code "08" covers repairs in the range 75% to less than 85%;
- Code "09" covers repairs in the range 85% to less than 95%;
- Code "10" represents disrepair requiring renewal of 95% or more.

NOTE: Surveyors must undertake their **assessment of each element in isolation**. The surveyor **must not take account of associated work** to other elements. The models used to establish the cost of work has an in-built allowance for the cost of associated work and therefore recording associated work separately, where it is not justified in its own right, will result in an over-counting of costs.

The surveyor's assessment of the area of the element in **disrepair can either reflect one occurrence of a defect or the aggregate area of two or more defects**.

Guidance on the assessment of repair is provided in Part 3.

IS THE REPAIR URGENT?

Surveyors are required to determine whether repairs recorded to be done urgently. Where no disrepair is recorded then a surveyor will need to assess whether normal or urgent maintenance is required. This is a change from the previous surveys where urgency was classified as not applicable for no disrepair. This change is to address the requirements of Historic Scotland with regard to building maintenance.

Urgent repairs are: those elements associated with keeping the building envelope in a wind and weather tight condition. If left unattended, these repairs will result in a further deterioration in the fabric of the block/dwelling; or

those associated with the health, safety or wellbeing of the occupants of the block/dwelling.

Non urgent repairs: those elements in disrepair which are not considered to be urgent

Urgent Maintenance: elements not in disrepair (score 00) but requiring to be maintained urgently.

Normal maintenance: the norm for elements not in disrepair

Not Applicable: those elements which do not exist in the common access area

REPAIR REQUIRED

Code 1: YES, THE REPAIR IS URGENT

Code 2: NO, THE REPAIR IS NOT URGENT

NO REPAIR

Code 3: URGENT MAINTENANCE REQUIRED

Example: A single cracked/broken pane of glass outwith the reach of the occupants should be considered as urgent maintenance. If left to normal maintenance then possible minor water penetration may occur or a faster deterioration of the element could occur.

Code 4: NORMAL MAINTENANCE

This should be considered the norm for elements not in disrepair.

NO ELEMENT

Code 8: NOT APPLICABLE

the element(s) does not exist.

Code 9: UNOBTAINABLE

You are unable to determine if the element(s) exist.

RESIDUAL LIFE

You are required to provide an estimate of the residual life of an element assuming that any disrepair recorded at the REPAIRS column is repaired immediately. This estimate is to be made for the whole element and not just that part of it that may require repairing. The answer code used by you should reflect the number of years that will elapse before the replacement of the element(s) becomes the only sensible option. This will normally represent the remaining life of that portion of the element(s) that does not require repair at this time.

The table below outlines **all** possible combinations of scores to be recorded in Section P.

Repairs	Urgency	Residual Life
"00"	"3" or "4"	"1", "2", "3" or "4"
"01" to "10", "55"	"1" or "2"	"1", "2", "3" or "4"
"88"	"8"	"8"
"99"	"9"	"9"

EXPECTED LIFE OF MATERIALS/ELEMENTS

The following list is derived from Life Expectancies of Building Components published by the RICS in August 1992, and it is provided as guidance on the expected life of materials/elements when first installed. This list should only be used as an aid in your assessment of residual life as many factors will contribute towards the life expectancy of a material/element.

It is crucial that your assessment of the residual life of an element/material should be derived from a review of its condition in conjunction with its expected life. For example because a softwood window is 25 years old does not automatically mean that it should be replaced.

You should **assume that normal maintenance is undertaken** in your assessment of the residual life of elements.

Question	Material/Element	Expected Life (Years)
P1	Stairs, landings and balustrades	30 - 100
P2	Access balcony/gallery/decks & balustrades	30 – 100
P3	Halls and passages	30 – 100
P4	Wall finishes	Plaster 30 – 60
P5	Ceilings and soffit finishings	Plaster 30 – 60
P6	Doors, screens, windows and roof lights	Softwood 25 – 60
		Hardwood 30 – 50
		UPVC 30 – 50
		Metal 30 - 50
P7	Lifts	30 – 50
P8	Decoration	5 – 10
P9	Service Mains	25 – 40
P10	Public lighting to common areas	20 – 30
P11	Communal security systems	15 – 25
P12	Refuse chute/chambers	30 – 60
P13	Bin stores	30 – 60

NOTE: The assessment of **P1, P2 and P3** should include the following:

- cracking or disintegration of concrete slab or treads to stairs;
- evidence of movement of slab;
- corrosion to steelwork;
- damage to finishes;
- broken sections to balustrades, loose or missing guard/hand rails
- damaged or ineffective fixings.

P1. Stairs, landings and balustrades

You should base this area based assessment on the staircases recorded at O3 (Number of staircases in the block).

Example of urgent maintenance would be where, say, a wooden handrail has splinters protruding but the handrail is basically in good condition. The splinters could cause injury to occupants.

P2. Access balcony/ gallery / decks and balustrades

Here, you must assess (linearly) the horizontal component of access balconies, galleries and decks here.

The vertical component of these access types should be recorded at P1.

Example of urgent maintenance would be where, the drainage gullies are choked and needing emptied.

P3. Halls and passages

Surveyors must linearly assess the horizontal component of halls and passages here.

The vertical component of these access types, including the landing, should still be recorded at P1.

NOTE: You should **only assess the standard of repair of the type of common access present within the block (O2).**

There will normally only be one form of common access within a block and you should therefore assess the standard of repair against the appropriate question (P1, P2 or P3) and record "88"/"8"/"8" (not applicable) against the other two questions.

Where more than one type of common access is present within the block (Code 7 at O2) you should assess the disrepair against the two or three appropriate questions from P1, P2 and P3.

P4. Wall finishes

Disrepair to wall finishes is assessed on an area basis. Your assessment should include the following:

- disrepair to all proprietary finishes including skirtings;
- cracking, crumbling or un-bonding of plaster/render;
- decaying boarding or mortar joints.

P5. Ceiling and soffit finishes

Disrepair to ceiling and soffit finishes is assessed on an area basis. Your assessment should include the following:

- cracking, crumbling or un-bonded plaster/render;
- bulging to ceiling linings or soffits;

- loose lining boards;
- impact damage.

P6. Doors, screens, windows and rooflights

Disrepair to doors, screens, windows and roof lights is assessed on a cumulative unit basis. You should apportion disrepair in line with the guidance given for individual elements.

Your assessment should include the following:

- distorted or unseated frames;
- rotting or broken woodwork or metalwork;
- broken/rusting/corroding ironmongery or fittings;
- defective putty, mastic or other sealant/flashings;
- broken glazing;
- impact damage.

P7. Lifts

Disrepair to lifts is assessed on all of the lifts recorded at O4 (Number of lifts in the block).

Your assessment should be restricted to disrepair to the following elements (the percentages indicate the proportion that each element represents within the whole):

- lift call panel; 10%
- lift control panel; 10%
- lift car; 60%
- lift doors. 20%

Disrepair to lifts is often linked to vandalism.

NOTE: You are not expected to inspect the lift motor room. The operational status of lifts is also not to be considered here.

P8. Decorations

Disrepair to decoration is assessed on an area basis. This will cover all walls, ceilings and soffits. Urgent maintenance is not expected to be an option in this element

P9. Service mains

Disrepair to service mains (including dry risers) is assessed on a linear basis.

P10. Public lighting to common areas

Disrepair to public lighting (including emergency lighting if present) is assessed on a linear (wiring) and unit (light fittings) basis.

Missing or blown light bulbs are likely to be classified as urgent maintenance.

P11. Communal security systems

Disrepair to communal security systems is assessed upon the condition of:

- the call panel located at the main entrance door to the block;
- the condition of wiring within the common circulation areas;
- the handset within the selected dwelling [where a full survey is achieved].

For the purposes of this survey the condition of the handset within the selected dwelling can be taken as representative of all of those connected to the system.

P12. Refuse chutes/chambers

Disrepair to refuse chutes/chambers is assessed upon the condition of :

- refuse chutes and linings; 60%
- hoppers; 10%
- chambers; 20%
- drainage to system. 10%

The percentages indicate the proportion that each element represents within the whole.

Gullies which require to be emptied are an example of urgent maintenance.

P13. Bin stores

Disrepair to bin stores is assessed upon the condition of :

- the structure of the bin store; 40%
- doors; 30%
- ironmongery; and 20%
- drainage to stores. 10%

The percentages indicate the proportion that each element represents within the whole.

Gullies which require to be emptied are an example of urgent maintenance.

Section Q. External Construction/ Materials

Section Q is to be completed for the whole building - either the single dwelling house or the common block containing the selected dwelling - as previously recorded at D1 or E2.

Q1. Is more than two thirds of the attached flank wall(s) exposed?

Mid-terrace, end-terrace or semi-detached dwellings or common blocks (C1 Codes 1,2,3 and 4 or E2 Codes 1, 2 and 3) which have only two or three external walls may also have significant exposed area(s) to the attached party wall(s).

These walls, known as flank walls, may rise above or project beyond the adjoining structure.

Where this occurs, you should record the extent of the exposed flank wall area(s) at Q1 (Codes 2 or 3).

Disrepair to these flank walls should be recorded in Section R where Viewpoint 1 will be coded "2" or "3" and/or Viewpoint 2 will be coded "5" or "6".

SEE DIAGRAM Q1 and R1-R18.

Code 1: NO

Less than two thirds of the attached party wall(s) is exposed.

Code 2: YES, ONE FLANK

More than two thirds of one party wall is exposed.

Code 3: YES, BOTH FLANKS

More than two thirds of both party walls are exposed.

Code 4: DETACHED

The dwelling or block is detached and therefore has no party/flank walls.

Code 9: UNOBTAINABLE

You are unable to determine if more than two thirds of the attached flank wall(s) is exposed.

DIAGRAM Q1

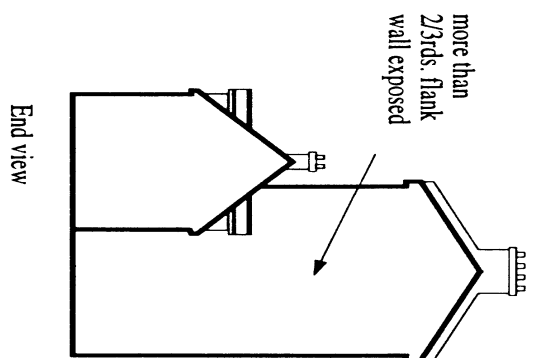
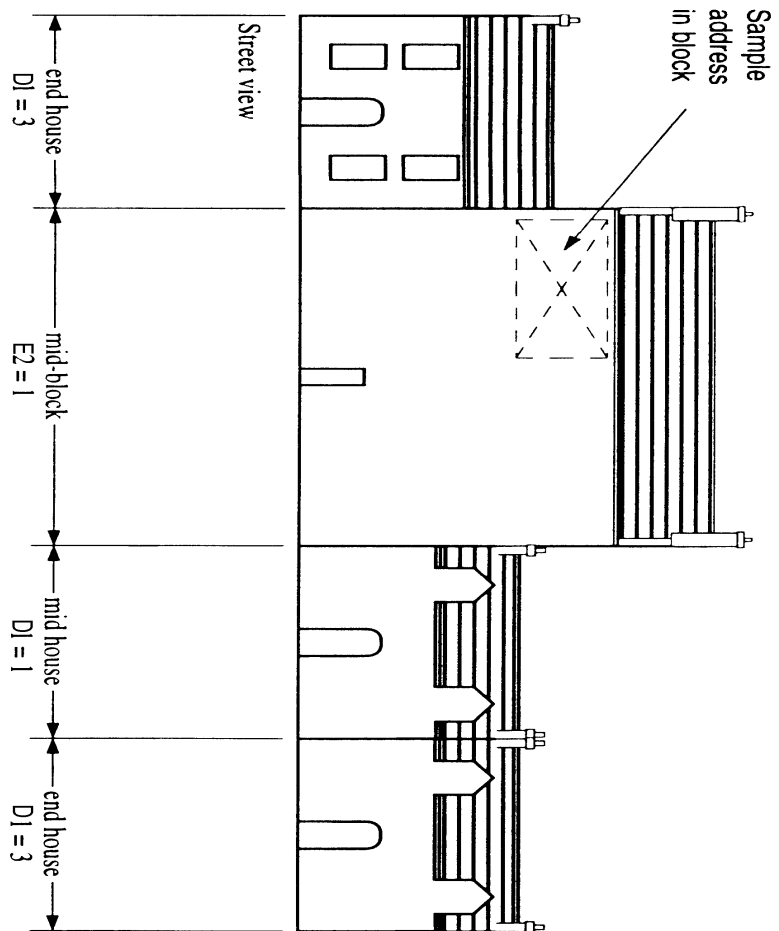

The mid-block has more than 2/3rds of its flank walls exposed. Q1 = Code 3. (survey as detached for repair and viewpoints.)

Q2. Principal external wall construction – original dwelling

Surveyors are being asked to assess the largest proportion of walling to the original dwelling. Any extensions are ignored here. This is primarily being introduced to help provide data for Historic Scotland but will feed into the new energy reporting requirements.

Where surveyors find different external walls cover equal areas, select the higher cost material as the principal in line with the standard survey protocol.

Code 1: SOLID

Solid bonded walls of any thickness constructed from brick, block, stone or concrete “no-fines”.

Timber frames with metal lathe fixed directly to the frame and a render then applied to the lathe should be recorded as solid.

Code 2: CAVITY

All cavity walls including cavity panels in framed structures and timber framed wall construction.

Code 3: OTHER

Hybrid, non-traditional and other mixed systems.

Code 9: UNOBTAINABLE

You are unable to determine the construction of the external walls.

NOTE: Dry lining of walls does not constitute a cavity.

Q3. Principal external wall construction material

NOTE: This is the material providing the structural support to the dwelling.

Code 1: STONE

Load bearing, cavity or solid stone external wall. Sandstone is traditionally found on the West coast of Scotland, particularly in the Glasgow area. Most of the pre- 1919 traditional stone built tenements, and houses of the same period, in Glasgow are constructed from sandstone of various colours (although the two predominant colours are red and blonde).

Code 2: CLAY/EARTH

Load bearing, clay or earth wall. Rare and most likely to be found on the east coast around Arbroath and on the north coast between Lossiemouth and Burghead. This was a method of construction introduced by the MOD although some newer properties encompass this method of construction. Usually single storey with very thick walls.

Code 3: BRICK

Load bearing, cavity or solid brick built wall. When rendered over, it may be difficult to determine whether brick is present under the rendering or roughcasting unless there are patches where the render or roughcast has come away from the wall.

Code 4: BLOCKWORK

Load bearing, cavity or solid concrete block wall construction, but not in-situ frames or pre-fabricated blocks or panels.

Code 5: TIMBER

Timber frame – brick, stone or timber clad, cavity or sandwich wall construction.

Code 6: CONCRETE

In-situ frames or pre-fabricated panels, no fines concrete.

Code 7: METAL

Steel frame or specialised non-traditional.

Code 8: OTHER – SPECIFY IN SURVEYOR NOTES

Code 9: UNOBTAINABLE

You are unable to determine the external wall material.

NOTE: When the wall material is covered with harling etc. you should use your knowledge of building construction in order to make a judgement.

Code 9 (unobtainable) should not be selected automatically under such circumstances. It should only be used when you can derive no clues as to the type of external wall material used.

Q4. Principal external wall finish

NOTE: For the purposes of this survey the slope of a mansard roof is not to be considered as a wall finish.

Code 1: RENDER

Render or harling on any backing, including external insulation with or without paint or textured finish.

Code 2: STONE

Natural stone finish, or stone painted or covered with a textured finish.

Code 3: BRICK

Natural brick finish, or brick painted or covered with a textured finish.

Code 4: TIMBER

Timber cladding, including non load bearing panels.

Code 5: CONCRETE BLOCK

Concrete block finish, or concrete block painted or covered with a textured finish.

"Stone cladding" should be recorded here.

Code 6: CONCRETE PANEL

Concrete panel finish, or concrete panel painted or covered with a textured finish.

Code 7: METAL

Metal finish, including preformed cladding for external insulation and weather proofing.

Code 8: OTHER (Surveyor notes)

PVC, GRP, asbestos or similar coverings and applied DIY coverings. Surveyors must add a comment in the surveyors notes.

Q5. If stone, type of stone

This provides a description of the stone finish to the dwelling and is being introduced as part of the suite of questions for Historic Scotland.

A stone wall construction with a render finish would score not applicable (8) here. The wall construction is known to be stone (Q3) but the finish is render so not applicable here.

Code 1: GRANITE

medium to coarse grained igneous rock dominated by Quartz and pink or white Feldspars with Mica (you should be able to see individual crystals). Usually occurs in relatively large bodies of rock. Used for building predominantly in Aberdeenshire and SW Scotland but there are many local sources across Scotland.

Code 2: WHIN

Vernacular term covering fine-grained igneous rock types – usually dark in colour but can be pink/grey - with individual crystals indistinguishable. It is normally very hard. It occurs in localised igneous intrusions such as sills, dykes, volcanic plugs and lava flows. People will also use the terms 'dolerite', 'basalt' 'road stone, lava, dyke rock and so on as synonyms. It occurs across Scotland but especially in the central valley of Scotland and in some of the Inner Hebrides.

Code 3: SANDSTONE

hard, durable building stones formed by the weathering and erosion of all types of pre-existing rocks. Vary from fine, medium to coarse grain and in colour from reds, greys and buff. Used very widely in the central belt and locally elsewhere. Principal building stone of Edinburgh and Glasgow areas.

Code 4: OTHER LOCAL STONE - SPECIFY IN SURVEYOR NOTES

(Southern Upland) Greywackés: An often grey sedimentary rock which can be dominated by **sandstone** but also by a clay matrix generally. It is characterized by its hardness, dark color, and poorly-sorted, angular

grains of **quartz, feldspar**, and small rock fragments set in a compact, **clay-fine** matrix. It may well have a strong coarse slaty cleavage. The term covers a multitude of rock types formed in a large geosyncline running across the Scottish Borders and Dumfries and Galloway giving rise to the Southern Uplands and a corrugated landscape, although in lowland areas this is usually hidden by later glacial deposits.

(Highland) (micaceous) schists: The schists are medium-grade metamorphic rocks, chiefly notable for the preponderance of lamellar minerals such as **micas, chlorite, talc, hornblende, graphite, and others**. This is often reflected in the rock fracture properties which can make it easy to build with. By definition, schist contains more than 50% platy and elongated minerals, often finely interleaved with **quartz and feldspar**. Schist is often garnetiferous.

(Lewisian) Gneisses: These are the oldest rock in the British Isles and are hard, deformed extensively into banded, often lenticular rocks but can have a structure to produce useful building stones. There are several rock types are found in the Lewisian Complex. **Felsic gneisses** form from igneous rocks of acid composition such as **granites and mafic gneisses** from basic igneous rocks such as gabbros.

Gabbros: These are coarse, dark igneous rocks formed in relatively large bodies such as magma chambers. There should be no free quartz. They should, where not freshly exposed quickly shows signs of weathering. Found in the tertiary volcanic centres in the Inner Hebrides.

Slates: These are thinly cleaved fine grained sedimentary rocks, typically from Ballachulish and south of Oban mainly used for roofing but where abundant used as a building stone.

Limestones: Calcium carbonate rich sedimentary rocks – **often grey and fossiliferous**. Not widespread though there are Jurassic limestones on Skye and Raasay, Carboniferous limestones in the Central Valley and Cambrian limestones in the North West Highlands

Flints: Hard, amorphous silica nodules imported from England or Northern Ireland.

Mudstones: Where hardened enough can be used a building stone – very fine grained, often with sedimentary lamellae – may be grey, pink or greenish.

Code 8: NOT APPLICABLE (NOT STONE)

Code 9: UNOBTAINABLE

Q6. Type of stone coursing

Code 1: ASHLAR - dressed stonework of any type, where the blocks have squared sides, carefully squared corners, and are laid in regular courses, usually with fine joints. The faces of the stones are generally smooth and polished, but can be tooled.

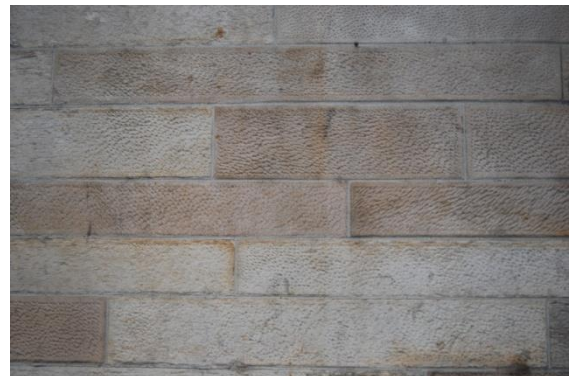
**Ashlar****Broached Ashlar****Rock-faced Ashlar****Rusticated Ashlar****Broached Ashlar****Stugged Ashlar****Code 2: COURSED SQUARED**

Stones not fully dressed but squared and laid on a regular horizontal bed. May vary from roughly squared to squared and tooled but typically of irregular size.



Code 3: RANDOM SQUARED

Stones of various sizes, partially dressed and roughly squared. Laid in irregular pattern without horizontal coursing.

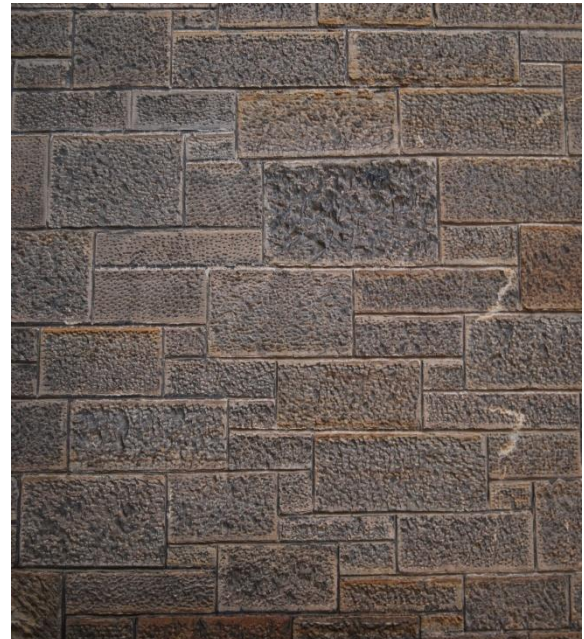
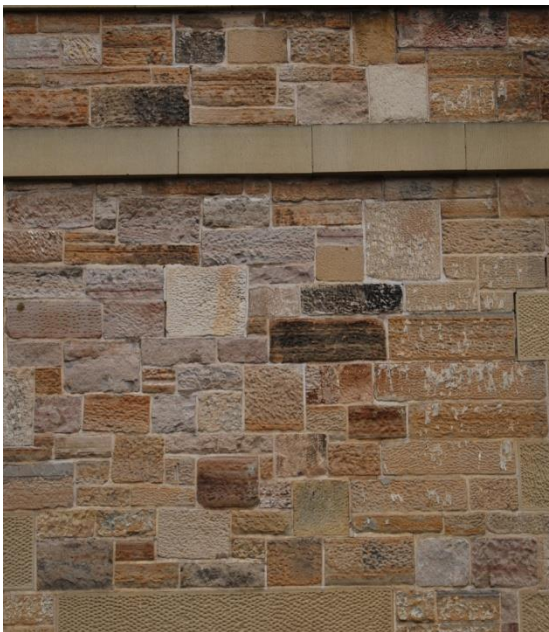

Code 4: RANDOM RUBBLE

Stones natural in shape and not tooled or squared. Irregular in size and laid without horizontal coursing.



Code 8: NOT APPLICABLE (NOT STONE)

Q7. Principal external wall thickness

This wall measurement includes the complete thickness of the external wall, from the room side surface of the inside wall through to outside surface of the external wall, including the rendered finish if present.

Where the elevations associated with the principal wall have a different thickness but the same type of stone finish and coursing calculate an approximate average and select the appropriate code.

Code 1: <450mm

Use for wall thicknesses up to 450mm.

Code 2: 450-750mm

Use for walls between 450 and 750mm thick.

Code 3: >750mm

Use for wall thicknesses over 750mm.

Code 9: UNOBTAINABLE

You are unable to determine the thickness of the external wall.

Q8. Has additional insulation been added to the principal external walls since built?

The important condition here is that the **INSULATION** has been **ADDED** to the external wall **SINCE** it was **ORIGINALLY BUILT**. This question differs from those about the absolute total thickness of the insulation earlier in Section M on loft and floor insulation

Walls have been required to meet insulation standards since 1976, and therefore may have insulation included within them already to comply with the Building Regulations (for example, timber frame walls). The energy programs use the dwelling's age to calculate the basic wall insulation U value. If you indicate that additional wall insulation has been added then the computer program will recalculate the U value to take that into account.

Thus, if you record that a dwelling built in 1995 has 150 mm of insulation within the wall (both internal and external say) the program may assume that the wall already has (say) 75 mm of insulation and then add another 150 mm of insulation, to calculate the wall U value for a wall with 225 mm of insulation.

Timber framed walls do NOT have a cavity for insulation purposes. It is highly unlikely that stone built dwellings will have been cavity insulated.

Code 1: NONE

No insulation has been added to the external walls since built, or only some of the external walls have been insulated since originally constructed.

This answer does not mean that there is no insulation within the wall. It means there is no more than when the dwelling was constructed originally.

For dwellings constructed from 1976 and beyond, the assumption is that the walls have insulation already to comply with the Building Regulation thermal standards. This applies to whether the dwelling is built of stone, brick, or concrete or timber framed.

Code 2: CAVITY

With cavity wall insulation look for a drilling pattern in the wall drill holes about 1 inch or 25mm in diameter that have been filled with render or cement: look for the slight discolouration. The more professional the contractor, the harder it will be to spot the drilling pattern. The easiest place to look is beneath the windows, where a 'W' pattern is likely to present itself. You may ask the householder, but do not take their word completely. If they say, 'yes', seek corroborating evidence (drilling pattern in the wall; if you can get to it; or ask to see a guarantee or certificate from the contractor all material suppliers now provide these as routine).

If the cavity has been insulated since the dwelling was originally constructed, then calculate the thickness of the cavity. However, a traditional rendered brick cavity brick (or block) wall plastered internally will be about 300 330 mm in thickness. Within this range, assume that the cavity is 50mm. If the wall thickness of a traditional rendered brick cavity brick construction is more than 330mm then assume that the cavity width is around 75mm. With other constructions, estimate the thickness of the wall components to determine the cavity thickness. You will record the thickness of insulation at Q9 below.

Code 3: INTERNAL

Determining whether the walls of a dwelling have been insulated internally is more problematic because neither the materials nor their thickness can be seen, unless a disruptive survey has been carried out or there are holes in the wall. Dry-lining, or installing a false wall, may be carried out as an anti condensation measure as well as a insulation

measure, but in both cases the plasterboard may or may not be insulated.

Where internal insulation is included in the dry-lining, it is unlikely to be more than 50mm in thickness (excluding the thickness of the plasterboard). A wall that has been dry-lined internally will sound hollow when tapped compared to one plastered on the hard. If the added thickness to the wall is in excess of about 35 40mm, it is likely that some insulation has been included. One last test involves touching the wall with the back of the hand. Does it feel much warmer than an external wall in the same house where there is no dry-lining? (This test will not work particularly well in the summer.)

Code 4: EXTERNAL

For external wall insulation, it is more obvious. External wall insulation systems comprise some form of insulation board, various coats of render and probably a final roughcast coat to provide it with a robustness to withstand damage from vandals and the weather. Estimate the thickness of the insulation material by measuring the thickness of the insulation system. As the thickness of the top coats of render will be included within this measurement but will not perform as well as the insulation, select the nearest thickness of insulation below the thickness of the system actually measured. For example, if the total thickness of the external insulation system measured 55 mm and the finish is 20 mm , enter 055 at Q9 below of external insulation.

Code 5: CAVITY AND INTERNAL

The wall has a combination of both cavity and internal insulation. Surveyors assess the total thickness of additional insulation and record at Q9.

Code 6: CAVITY AND EXTERNAL

The wall has a combination of both cavity and external insulation. Surveyors assess the total thickness of additional insulation and record at Q9.

Code 7: INTERNAL AND EXTERNAL

The wall has a combination of both internal and external insulation. Surveyors assess the total thickness of additional insulation and record at Q9.

Q9. Thickness of internal or external insulation added to the principal external walls since built?

The important condition here is that this records **INSULATION** has been **ADDED** to the external wall **SINCE** it was **ORIGINALLY BUILT**. This question differs from those about the total thickness of the insulation earlier in Section M on loft and floor insulation.

Walls have been required to meet insulation standards since 1976, and therefore may have insulation included within them already to comply with the Building Regulations (for example, timber frame walls). The energy programs use the dwelling's age to calculate the basic wall insulation U value. If you indicate that additional wall insulation has been added then the computer program will recalculate the U value to take that into account.

Thus, if you record that a dwelling built in 1995 has 150 mm of insulation within the wall (both internal and external say) the program may assume that the wall already has (say) 75 mm of insulation and then add another 150 mm of insulation, to calculate the wall U value for a wall with 225 mm of insulation.

Timber framed walls do NOT have a cavity for insulation purposes. It is highly unlikely that stone built dwellings will have been cavity insulated. They may have had external insulation added though.

SPECIFY

000 – Surveyors have assessed **no** additional wall insulation has been added since original construction and have scored 1 at Q8 above.

nnn – Surveyors have assessed some additional wall insulation has been added since original construction and enter the thickness here using leading zeroes.

Code 999: UNOBTAINABLE

Q10. Extent of principal external wall

Surveyors are being asked to assess the extent of largest proportion (to nearest 10%) of walling to the original dwelling. Any extensions to the dwelling are ignored here.

Where surveyors find different external walls cover equal areas, select the higher cost material as the principal in line with the standard survey protocol.

SPECIFY: **nn%** - normally 05 or greater using the boxes provided.

Code 99: UNOBTAINABLE

Secondary External Wall of original dwelling as defined by age at C4.

Surveyors are being asked to assess the smaller proportion of walling to the original dwelling. Any extensions to the dwelling collected later in the form. This is primarily being introduced to help provide data for Historic Scotland but will feed into the new energy reporting requirements.

Q11 to Q18 is essentially a rinse and repeat of Q2 to Q9 but associated with the secondary external wall of the original construction.

Q11. Secondary external wall construction

NOTE: If there is no secondary wall construction then surveyors should score 8 (not applicable) here and leave Q12 to Q18 blank

Code 1: SOLID

Solid bonded walls of any thickness constructed from brick, block, stone or concrete “no-fines”.

Timber frames with metal lathe fixed directly to the frame and a render then applied to the lathe should be recorded as solid.

Code 2: CAVITY

All cavity walls including cavity panels in framed structures and timber framed wall construction.

Code 3: OTHER

Hybrid, non-traditional and other mixed systems.

Code 8: NOT APPLICABLE

No secondary wall construction.

Code 9: UNOBTAINABLE

You are unable to determine the construction of the external walls.

NOTE: Dry lining of walls does not constitute a cavity.

Q12. Secondary external wall construction material

NOTE: This is the material providing the structural support to the secondary walls of the dwelling.

All as Q3 but for secondary wall

Q13. Secondary external wall finish

All as Q4 but for secondary wall.

Q14. If stone, type of stone

All as Q5 but for secondary wall.

Q15. Type of stone coursing – secondary external wall

All as Q6 but for secondary wall.

Q16. Secondary external wall thickness

All as Q7 but for secondary wall.

Q17. Has additional cavity insulation been added to the secondary external walls since built?

All as Q8 but for secondary wall.

Q18. Thickness of internal or external insulation added to the secondary external walls since built?

All as Q9 but for secondary wall.

Q19. Principal roof type

NOTE: The principal roof type is that which forms the main design feature of the **whole dwelling or block including extensions**.

Roof types that cover less than 10% of the total roof area should be disregarded.

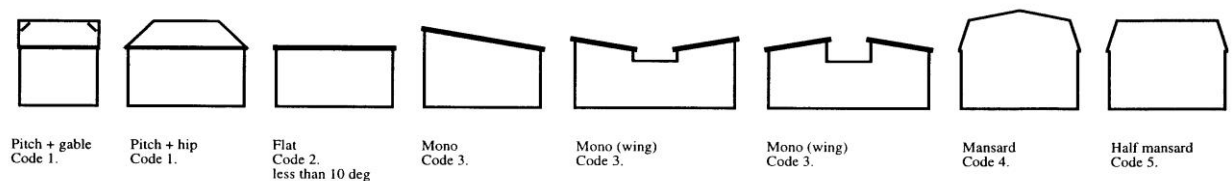
DIAGRAM Q19 - PRINCIPAL ROOF TYPE**Code 1: PITCHED**

The roof has more than one pitch, each with a slope of 10 degrees or more.

Code 2: FLAT

The roof has a pitch(es) of less than 10 degrees

Code 3: MONO

The roof has a single pitch with a slope of 10 degrees or more.

Include here double mono (or “wing”) roofs.

Code 4: MANSARD

A double pitched roof form to be considered for the purposes of this survey as a single type of roof.

Code 5: HALF MANSARD

A combination of pitched and flat roofs to be considered for the purposes of this survey as a single type of roof.

Code 6: VAULTED CEILING

Rather than a horizontal ceiling with a roof void above (e.g. Code 1 above), with the insulation usually sitting on the ceiling, the vaulted ceiling comprises a slope with the insulation built into the rafters, and two sloping sides meeting near the apex of the roof.

Code 9: UNOBTAINABLE

You are unable to determine the principal roof type.

Q20. Extent of principal roof type

You should assess the extent of the Principal Roof Type relative to the total roof area and record it to the nearest tenth.

SPECIFY: "06" is taken to mean that the Principal Roof Type covers approximately 60% (55% - 65%) of the total roof area. Use the boxes provided.

Code 99: UNOBTAINABLE

You are unable to determine the extent of the principal roof type.

Q21. Principal roof cover

The Principal Roof Cover is the material that covers the Principal Roof Type.

Where there is more than one type of material covering the Principal Roof Type you should record the type that covers the greatest area.

Where there are two, or more, materials covering the Principal Roof Type that are present in equal areas you should record the material that has the greatest replacement cost attached to it.

Code 1: SLATES

Natural slates.

Code 2: TILES

Concrete or clay tiles. (Use this code for artificial slate.)

Code 3: FELT

All types of roof felt.

Code 4: ASPHALT

All types of asphalt.

Code 5: ASBESTOS

Asbestos tiles, asbestos cement tiles and corrugated sheeting.

Code 6: METAL

Ferrous and non-ferrous metal sheets.

Code 7: OTHER – SPECIFY IN NOTES

Local materials, turf etc.

Code 9: UNOBTAINABLE

You are unable to determine the cover to the principal roof.

Q22. If principal roof cover is slates or tiles
--

Code 1: SCOTS SLATE

The cover is of the scots slate type - diminishing slate courses as you approach the peak of the roof.

Code 2: ALL OTHER SLATE

The roof cover is natural slate not of the scots slate style.

Code 3: PANTILES

A clay roofing tile with an elongated S-shape laid so that the downward curve of one tile overlaps the upward curve of the adjoining tile.

Code 4: ROSEMARYS

Normally a small plain rectangular clay tile.

Code 5: OTHER TILES**Code 8: NOT APPLICABLE**

This is never used in this context

Code 9: UNOBTAINABLE

You are unable to determine the cover to the principal roof.

Q23. Secondary roof type

The secondary roof type is a roof type that remains of the total roof area once the principal roof type is discounted.

Where this leaves surveyors with a choice between two or more roof types (3 or more roof types present in total) the secondary roof type is that which covers the greatest area excluding the principal roof type.

Where there is more than one type of material covering the secondary roof type you should record the type that covers the greatest area or where the areas are the same the finish with the greatest cost.. This material can be the same as the principal roof type.

The presence of a secondary roof cover (and hence a secondary roof type) means that the principal roof type must cover less than 10 tenths of the whole dwelling – including all extensions (Q20). If a secondary roof type is too small to be recorded (less than

10%) then the material with which it is covered is ignored and code 8 should be recorded.

Code 1: PITCHED

The roof has more than one pitch, each with a slope of 10 degrees or more.

Code 2: FLAT

The roof has a pitch(es) of less than 10 degrees

Code 3: MONO

The roof has a single pitch with a slope of 10 degrees or more.

Include here double mono (or “wing”) roofs.

Code 4: MANSARD

A double pitched roof form to be considered for the purposes of this survey as a single type of roof.

Code 5: HALF MANSARD

A combination of pitched and flat roofs to be considered for the purposes of this survey as a single type of roof.

Code 6: VAULTED CEILING

Rather than a horizontal ceiling with a roof void above (e.g. Code 1 above), with the insulation usually sitting on the ceiling, the vaulted ceiling comprises a slope with the insulation built into the rafters, and two sloping sides meeting near the apex of the roof.

Code 8: NO SECONDARY ROOF

The dwelling does not have a secondary roof type

Code 9: UNOBTAINABLE

You are unable to determine the secondary roof type.

Q24. Cover to secondary roof type

The cover to the secondary roof type is the material that covers the secondary roof type.

NOTE: The secondary roof cover is never the material covering the second largest area of a Principal Roof Type with more than one covering. It is always linked to the presence of a distinct secondary roof type.

The secondary roof type is a roof type that remains once the Principal Roof Type is discounted.

Where this leaves surveyors with a choice between two or more roof types (3 or more roof types present in total) the secondary roof type is that which covers the greatest area excluding the principal roof type.

Where there is more than one type of material covering the secondary roof type you should record the type that covers the greatest area. This material can be the same as the principal roof type.

The presence of a secondary roof cover (and hence a secondary roof type) means that the principal roof type must cover less than 10 tenths of the dwelling (Q20). If a secondary roof type is too small to be recorded then the material with which it is covered is ignored and code 8 should be recorded.

Code 1: SLATES

Natural slates.

Code 2: TILES

Concrete or clay tiles. (Use this code for artificial slate.)

Code 3: FELT

All types of roof felt.

Code 4: ASPHALT

All types of asphalt.

Code 5: ASBESTOS

Asbestos tiles, asbestos cement tiles and corrugated sheeting.

Code 6: METAL

Ferrous and non-ferrous metal sheets.

Code 7: OTHER – SPECIFY IN NOTES

Local materials, turf etc.

Code 8: NOT APPLICABLE

There is no secondary roof

Code 9: UNOBTAINABLE

You are unable to determine the cover to the secondary roof.

Q25. If secondary roof cover is slates or tiles

Code 1: SCOTS SLATE

The cover is of the scots slate type - diminishing slate courses as you approach the peak of the roof.

Code 2: ALL OTHER SLATE

The roof cover is natural slate not of the scots slate style.

Code 3: PANTILES

A clay roofing tile with an elongated S-shape laid so that the downward curve of one tile overlaps the upward curve of the adjoining tile.

Code 4: ROSEMARYS

Normally a small plain rectangular clay tile.

Code 5: OTHER TILES

Code 8: NOT APPLICABLE

Not applicable – no secondary roof

Code 9: UNOBTAINABLE

You are unable to determine the cover to the principal roof.

Note on Q19 to Q25

To illustrate the definitions of primary and secondary roofs, consider the following examples:

A dwelling/block covered wholly by a pitched roof with Scots slate cover:

- Q19** "1" principal roof type is pitched.
- Q20** "10" principal roof type covers ten tenths of dwelling/block.
- Q21** "1" principal roof type is covered with slates.
- Q22** "1" type of slate is Scots slate construction .
- Q23** "8" there is no secondary roof type.
- Q24** "8" there is no secondary roof type.
- Q25** "8" n/a

A dwelling/block covered wholly by a pitched roof that has natural slate to the front and clay tiles to the rear:

- Q19** "1" principal roof type is pitched.
- Q20** "10" principal roof type covers ten tenths of dwelling/block.
- Q21** "1" the split between types of roof covering materials is 50:50 slate is selected because it is the higher cost item.

Where the split between roof covering materials is not equal you should select the material covering the larger roof area.

- Q22** "2" type of slate is other slate construction .
- Q23** "8" there is no secondary roof type.
- Q24** "8" there is no secondary roof type.
- Q25** "8" n/a

The presence of two roof covering materials to the principal roof type does not result in a secondary roof cover.

A single level dwelling/block covered wholly by a pitched roof that has natural slate to the front and clay tiles to the rear is doubled in size by a felt covered flat roof extension:

- Q19** "1" principal roof type is pitched.
- Q20** "05" principal roof type covers five tenths of dwelling/block.

Secondary roof type (flat roof) covers other five tenths

- Q21** "1" Assuming that the split between types of roof covering materials to the principal roof type is 50:50 slate is selected because it is the higher cost item.

Where the split between roof covering materials is not equal you should select the material covering the larger roof area.

- Q22** "2" type of slate is other slate construction .

- Q23** "2" secondary roof type is flat.

- Q24** "3" secondary roof cover is felt.

- Q25** "8" n/a (felt roof)

A dwelling/block with a mansard roof has been increased in size with a small “lean-to” type (single pitch therefore mono roof type) extension with an asbestos sheet roof:

- Q19** "4" principal roof type is mansard.

- Q20** "08" principal roof type covers eight tenths of dwelling/block.

Secondary roof type (mono roof) covers other two tenths.

- Q21** "1"

- Q24** "5" secondary roof covering (the covering to the secondary roof type - mono roof) is asbestos sheet.

- Q19** "4" principal roof type is mansard.

- Q20** "08" principal roof type covers eight tenths of dwelling/block.

- Q21** "1" type of cover is slate see note below

NOTE: With mansard (and half mansard) roof types the higher cost material (usually slate on the steeper pitch) is always recorded as the roof covering even when the lower cost item (usually felt on the lower pitch or flat section) covers a larger area.

- Q22** "2" type of slate is other slate (not scots slate).

- Q23** "3" mono pitch (lean to).

- Q24** "5" asbestos.

- Q25** "8" n/a (asbestos cover)

Q26. Extension 1 - NHER age category

Note that you should only record up to two extensions. If there are more than two don't combine, but do add in notes.

Please refer to M1 for guidance on aging extensions.

Code 01:	Pre-1919
Code 02:	1919 – 1929
Code 03:	1930 - 1949
Code 04:	1950 - 1964
Code 05:	1965 - 1975
Code 06:	1976 – 1983
Code 07:	1984 – 1991
Code 08:	1992 – 1998
Code 09:	1999 – 2002
Code 10:	2003 – 2007
Code 11:	2008 - 2011
Code 12:	2012 onwards
Code 88:	Not Applicable

Q27. Extension 1 - External wall construction

Surveyors are being asked to assess the largest proportion of walling to the original dwelling. This is primarily being introduced to help provide data for Historic Scotland but will feed into the new energy reporting requirements.

Where surveyors find different external walls cover equal areas, select the higher cost material as the principal in line with the standard survey protocol.

Code 1: SOLID

Solid bonded walls of any thickness constructed from brick, block, stone or concrete “no-fines”.

Timber frames with metal lathe fixed directly to the frame and a render then applied to the lathe should be recorded as solid.

Code 2: CAVITY

All cavity walls including cavity panels in framed structures and timber framed wall construction.

Code 3: OTHER

Hybrid, non-traditional and other mixed systems.

Code 9: UNOBTAINABLE

You are unable to determine the construction of the external walls.

NOTE: Dry lining of walls does not constitute a cavity.

Q28. Extension 1 – External wall construction material

NOTE: This is the material providing the structural support to the extension.

Code 1: STONE

Load bearing, cavity or solid stone external wall. Sandstone is traditionally found on the West coast of Scotland, particularly in the Glasgow area. Most of the pre- 1919 traditional stone built tenements, and houses of the same period, in Glasgow are constructed from sandstone of various colours (although the two predominant colours are red and blonde).

Code 2: CLAY/EARTH

Load bearing, clay or earth wall. Rare and most likely to be found on the east coast around Arbroath and on the north coast between Lossiemouth and Burghead. This was a method of construction introduced by the MOD although some newer properties encompass this method of construction. Usually single storey with very thick walls.

Code 3: BRICK

Load bearing, cavity or solid brick built wall. When rendered over, it may be difficult to determine whether brick is present under the rendering or roughcasting unless there are patches where the render or roughcast has come away from the wall.

Code 4: BLOCKWORK

Load bearing, cavity or solid concrete block wall construction, but not in-situ frames or pre-fabricated blocks or panels.

Code 5: TIMBER

Timber frame – brick, stone or timber clad, cavity or sandwich wall construction.

Code 6: CONCRETE

In-situ frames or pre-fabricated panels, no fines concrete.

Code 7: METAL

Steel frame or specialised non-traditional.

Code 8: OTHER – SPECIFY IN SURVEYOR NOTES**Code 9: UNOBTAINABLE**

You are unable to determine the external wall material. Code 9 (unobtainable) should not be selected automatically under such circumstances. It should only be used when you can derive no clues as to the type of external wall material used.

NOTE: When the wall material is covered with harling etc. you should use your knowledge of building construction in order to make a judgement.

Q29. Extension 1 – External wall finish

NOTE: For the purposes of this survey the slope of a mansard roof is not to be considered as a wall finish.

Code 1: RENDER

Render or harling on any backing, including external insulation with or without paint or textured finish.

Code 2: STONE

Natural stone finish, or stone painted or covered with a textured finish.

Code 3: BRICK

Natural brick finish, or brick painted or covered with a textured finish.

Code 4: TIMBER

Timber cladding, including non load bearing panels.

Code 5: CONCRETE BLOCK

Concrete block finish, or concrete block painted or covered with a textured finish.

"Stone cladding" should be recorded here.

Code 6: CONCRETE PANEL

Concrete panel finish, or concrete panel painted or covered with a textured finish.

Code 7: METAL

Metal finish, including preformed cladding for external insulation and weather proofing.

Code 8: OTHER (Surveyor notes)

PVC, GRP, asbestos or similar coverings and applied DIY coverings. Surveyors must add a comment in the surveyors notes.

Q30. Type of stone coursing to extension 1

Code 1: ASHLAR - dressed stonework of any type, where the blocks have squared sides, carefully squared corners, and are laid in regular courses, usually with fine joints. The faces of the stones are generally smooth and polished, but can be tooled.

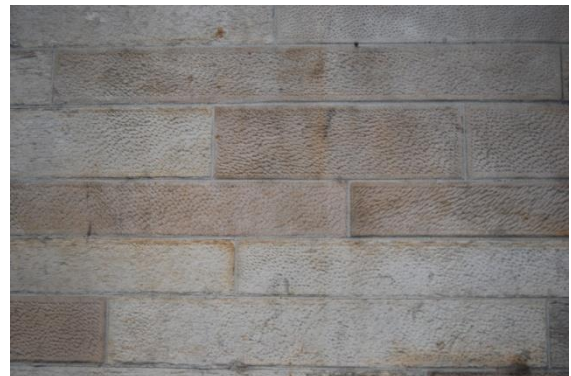
**Ashlar****Broached Ashlar****Rock-faced Ashlar****Rusticated Ashlar****Broached Ashlar****Stugged Ashlar****Code 2: COURSED SQUARED**

Stones not fully dressed but squared and laid on a regular horizontal bed. May vary from roughly squared to squared and tooled but typically of irregular size.



Code 3: RANDOM SQUARED

Stones of various sizes, partially dressed and roughly squared. Laid in irregular pattern without horizontal coursing.

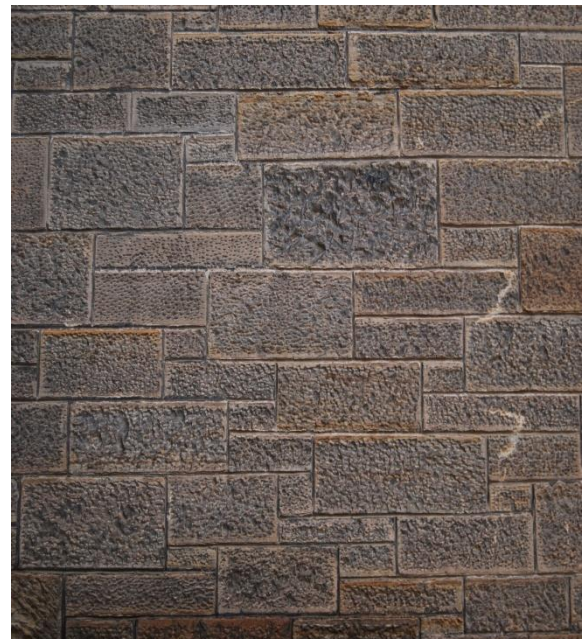
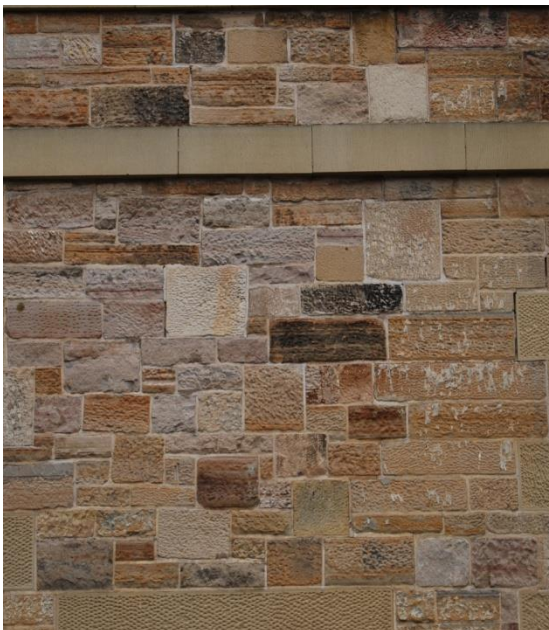

Code 4: RANDOM RUBBLE

Stones natural in shape and not tooled or squared. Irregular in size and laid without horizontal coursing.



Code 8: NOT APPLICABLE (NOT STONE)

Q31. Has additional cavity insulation been added to extension 1 external walls since built?

The important condition here is that the **INSULATION** has been **ADDED** to the external wall **SINCE** it was **ORIGINALLY BUILT**. This question differs from those about the absolute total thickness of the insulation earlier in Section M on loft and floor insulation

Walls have been required to meet insulation standards since 1976, and therefore may have insulation included within them already to comply with the Building Regulations (for example, timber frame walls). The energy programs use the dwelling's age to calculate the basic wall insulation U value. If you indicate that additional wall insulation has been added then the computer program will recalculate the U value to take that into account.

Thus, if you record that a dwelling built in 1995 has 150 mm of insulation within the wall (both internal and external say) the program may assume that the wall already has (say) 75 mm of insulation and then add another 150 mm of insulation, to calculate the wall U value for a wall with 225 mm of insulation.

Timber framed walls do **NOT** have a cavity for insulation purposes. It is highly unlikely that stone built dwellings will have been cavity insulated.

Code 1: NONE

No insulation has been added to the external walls since built, or only some of the external walls have been insulated since originally constructed.

This answer does not mean that there is no insulation within the wall. It means there is no more than when the dwelling was constructed originally.

For dwellings constructed from 1976 and beyond, the assumption is that the walls have insulation already to comply with the Building Regulation thermal standards. This applies to whether the dwelling is built of stone, brick, or concrete or timber framed.

Code 2: CAVITY

With cavity wall insulation look for a drilling pattern in the wall – drill holes about 1 inch or 25mm in diameter that have been filled with render or cement: look for the slight discolouration. The more professional the contractor, the harder it will be to spot the drilling pattern. The easiest place to look is beneath the windows, where a 'W' pattern is likely to present itself. You may ask the householder, but do not take their word completely. If they say, 'yes', seek corroborating evidence (drilling pattern in the wall; if you can get to it; or ask to see a guarantee or certificate from the contractor – all material suppliers now provide these as routine).

If the cavity has been insulated since the dwelling was originally constructed, then calculate the thickness of the cavity. However, a traditional rendered brick cavity brick (or block) wall plastered internally will be about 300–330 mm in thickness. Within this range, assume that the cavity is 50mm. If the wall thickness of a traditional rendered brick cavity brick construction is more than 330mm then assume that the cavity width is around 75mm. With other constructions, estimate the thickness of the wall components to determine the cavity thickness. You will record the thickness of insulation at Q9 below.

Code 3: INTERNAL

Determining whether the walls of a dwelling have been insulated internally is more problematic because neither the materials nor their thickness can be seen, unless a disruptive survey has been carried out or there are holes in the wall. Dry-lining, or installing a false wall, may be carried out as an anti condensation measure as well as a insulation measure, but in both cases the plasterboard may or may not be insulated.

Where internal insulation is included in the dry-lining, it is unlikely to be more than 50mm in thickness (excluding the thickness of the plasterboard). A wall that has been dry-lined internally will sound hollow when tapped compared to one plastered on the hard. If the added thickness to the wall is in excess of about 35–40mm, it is likely that some insulation has been included. One last test involves touching the wall with the back of the hand. Does it feel much warmer than an external wall in the same house where there is no dry-lining? (This test will not work particularly well in the summer.)

Code 4: EXTERNAL

For external wall insulation, it is more obvious. External wall insulation systems comprise some form of insulation board, various coats of render and probably a final roughcast coat to provide it with a robustness to withstand damage from vandals and the weather. Estimate the thickness of the insulation material by measuring the thickness of the insulation system. As the thickness of the top coats of render will be included within this measurement but will not perform as

well as the insulation, select the nearest thickness of insulation below the thickness of the system actually measured. For example, if the total thickness of the external insulation system measured 55 mm and the finish is 20 mm , enter 055 at Q9 below of external insulation.

Code 5: CAVITY AND INTERNAL

The wall has a combination of both cavity and internal insulation. Surveyors assess the total thickness of additional insulation and record at Q9.

Code 6: CAVITY AND EXTERNAL

The wall has a combination of both cavity and external insulation. Surveyors assess the total thickness of additional insulation and record at Q9.

Code 7: INTERNAL AND EXTERNAL

The wall has a combination of both internal and external insulation. Surveyors assess the total thickness of additional insulation and record at Q9.

Code 8: NOT APPLICABLE

This is included for consistency with the protocol but it is unlikely that surveyors will record a score here.

Q32. Thickness of internal or external insulation added to extension 1 external walls since built?

The important condition here is that this records **INSULATION** has been **ADDED** to the external wall **SINCE** it was **ORIGINALLY BUILT**. This question differs from those about the total thickness of the insulation earlier in Section M on loft and floor insulation.

Walls have been required to meet insulation standards since 1976, and therefore may have insulation included within them already to comply with the Building Regulations (for example, timber frame walls). The energy programs use the dwelling's age to calculate the basic wall insulation U value. If you indicate that additional wall insulation has been added then the computer program will recalculate the U value to take that into account.

Thus, if you record that a dwelling built in 1995 has 150 mm of insulation within the wall (both internal and external say) the program may assume that the wall already has (say) 75 mm of insulation and then add another 150 mm of insulation, to calculate the wall U value for a wall with 225 mm of insulation.

Timber framed walls do NOT have a cavity for insulation purposes. It is highly unlikely that stone built dwellings will have been cavity insulated. They may have had external insulation added though.

SPECIFY

000 – Surveyors have assessed no additional wall insulation has been added since original construction and have scored 1 at Q8 above.

nnn – Surveyors have assessed some additional wall insulation has been added since original construction and enter the thickness here using leading zeroes.

Code 999: UNOBTAINABLE

Q33. Average depth of roof/loft insulation for extension 1

The TOTAL thickness of loft insulation is to be recorded (see Codes below), i.e. whatever was installed when the dwelling was built **plus** any subsequently added.

Where the level of insulation varies, you should estimate the average thickness of the insulation across the overall roof space. Thus, if half of the loft area has 100mm of insulation and the rest none, the average would be 50mm.

NOTE: Do not look solely around the loft hatch opening, as the insulation in this area tends to get compressed when people access the loft space. Be sure to look out into areas near the eaves to ensure coverage (although you are not expected to actually enter the loft space). Items stored in the loft space do not constitute insulation and are therefore ignored in the averaging out of the total Insulation thickness. Unless it can be determined that partially boarded areas have loft insulation beneath the boards, then the presumption is there is none – this presumption is to be factored into the averaging out of the loft insulation thickness.

You should not attempt to guess the thickness of the loft insulation.

- Code 00: NONE**
- Code 01: 12mm**
- Code 02: 25mm**
- Code 03: 50mm**
- Code 04: 75mm**
- Code 05: 100mm**
- Code 06: 150mm**
- Code 07: 200mm**
- Code 08 : 250mm**
- Code 09: 270mm**
- Code 10: 300mm**
- Code 11: 350mm**
- Code 12: 400mm or more**
- Code 13: FLAT ROOF UNMEASURED**
- Code 88: NOT APPLICABLE**

The roof is a non heat loss roof (e.g. a mid-floor or ground floor flat).

Code 99: UNOBTAINABLE

Where the thickness of the insulation cannot be determined because of a lack of access to the loft space, you should enter Code 99. The computer program will select as a default the appropriate Scottish Building Regulation standard for dwellings of the relevant age.

Q34. Extension 1 – Insulation location**Code 1: RAFTERS**

The roof insulation is in the slope of the roof. It is possible in such warm roof constructions that the thickness of the insulation will not be able to be measured.

Code 2: JOISTS

The roof insulation is between or between and over the joists in the attic space. In such instances as long as there is access to the loft then it should be possible to measure the thickness of insulation.

Code 3: FLAT ROOF

The insulation (if there is any is within the flat roof construction) and it is unlikely that the thickness of insulation will be measureable.

Code 4: BOTH (JOISTS & RAFTERS)

This situation will apply where there is a room built into the roof space. It may also apply where the dwelling has an attic space with insulation between the joists and insulation has been also placed on the underside of the roof between the rafters. In such a situation ONLY measure the thickness of the insulation between the joists – do not include the thickness of the insulation between the rafters, i.e. do NOT add the two thicknesses together.

Code 8: NOT APPLICABLE

The roof is a non heat loss roof (e.g. a mid-floor or ground floor flat).

Code 9: UNOBTAINABLE

This option should be rare; an estimate of the insulation position should be possible.

Q35. Extension 2 - NHER age category

Please refer to Q26.

Q36. Extension 2 - External wall construction

Please refer to Q27.

Q37. Extension 2 – External wall construction material

Please refer to Q28.

Q38. Extension 2 – External wall finish

Please refer to Q29.

Q39. Extension 2 – Type of stone coursing

Please refer to Q30.

Q40. Extension 2 – Has additional cavity insulation been added to external walls since built?

Please refer to Q31.

Q41. Extension 2 – Thickness of internal or external insulation added to external walls since built?

Please refer to Q32.

Q42. Extension 2 – Average depth of roof/loft insulation

Please refer to Q33.

Q43. Extension 2 – Insulation location

Please refer to Q34

Note of Q44 to Q50

Questions Q44–Q50 are to be answered for the whole dwelling.

The NHER assessment incorporated within the SHS differentiates between windows according to frame type and level of glazing.

Where there are two or more frame types and/or levels of glazing within the selected dwelling you should make your assessment upon the basis of **the largest glazed area** rather than upon the number of windows.

Q44. Principal window type to dwelling

Code 1: SASH & CASE

Sash and case type or sliding sash type

Code 2: CASEMENT

Casement type, main sash side hung opening outwards. May be top hung only.

Code 3: TILT & TURN

Window type with two operating methods, often side and bottom hinged.

Code 4: PIVOT

Turn over type with safety catch.

Code 5: OTHER/MIXED

To be used for a mixture of window types within the same dwelling. The mixture of window types is approximately a 50/50 split.

Code 9: UNOBTAINABLE

You are unable to determine the principal window type to the dwelling.

Q45. Window frames

The frame options should be obvious except in the case of aluminium with a thermal break compared with aluminium without a thermal break.

Code 1: WOOD

Code 2: METAL (THERMAL BREAK)

Code 3: METAL (NO THERMAL BREAK)

A thermal break is a layer of insulation included within the metal window frame to reduce their cold bridging effect around double glazed units. Older single, glazed, steel framed windows and early double glazed aluminium windows do not have thermal breaks included within them. Sometimes a black plastic separator can be seen between the external part of the frame and the internal part of the frame indicating the presence of a thermal break particularly if you examine the frame section when you open the window.

Two other tests to try when you have a metal window, are to ask the householder if they get condensation on the window frame (as opposed to the window). If there is no thermal break then condensation is more likely to occur. A second test is to place the palm of your hand on the glass of the window and on the metal frame. If the frame feels as cold as or colder than the glass, it is likely that the window does not have a thermal break.

NOTE: If you are not sure whether or not a metal frame has a thermal break, you should default to Code 3.

Code 4: UPVC

This code only used where there is a uPVC window frame with single glazing. If uPVC double or triple glazing (which will be most uPVC window frames then Code 5, 6 or 7 should be used)

Code 5: UPVC 6mm gap

Double glazed window with uPVC frame and the gap between the two panes of glass is only 6mm, i.e. very narrow). Typical of early double glazing.

Code 6: UPVC 12mm gap

Double glazed window with uPVC frame and the gap between the two panes of glass is 12mm. If the gap is adjudged less than 12mm but more than 6mm (e.g. 10mm gap) then round down to 6mm (i.e. code 5)

Code 7: UPVC 16mm or more

Double glazed window with uPVC frame and the gap between the two panes of glass is 16mm or more.

Q46. Glazing (if some single & some double select largest area)
--

Code 1: SINGLE

A single pane of 'glass' within the window opening.

Code 2: DOUBLE PRE 2003

Two panes of 'glass' within the window opening. The 'glass' may actually be another material, for example, acrylic. These may be either sealed units or factory units. From the thermal point of view, the difference between the two is not significant, regardless of the cost to the householder.

Code 3: DOUBLE POST 2003

Two panes of 'glass' within the window opening. The 'glass' may actually be another material, for example, acrylic. These may be either sealed units or factory units. From the thermal point of view, the difference between the two is not significant, regardless of the cost to the householder.

Code 4: DOUBLE UNKNOWN

Code 5: TRIPLE GLAZING

Three panes of glass within the window opening. These may be either sealed units or factory units or may be secondary glazing or some combination of glazed units and secondary glazing.

Code 6: DOUBLE SECONDARY

Two panes of 'glass' within the window opening. The 'glass' may actually be another material, for example, acrylic. The inner glass may be removable. From the thermal point of view, the difference between the two is not significant, regardless of the cost to the householder.

Code 9: UNOBTAINABLE

Q47. Extent of double glazing

This question is trying to provide an estimate of the proportion of number of properties which have some level of double glazing.

Use the 10 point scale for measurement (area based)

SPECIFY: 0,55, 01-10

Code 88: Not Applicable

Not to be used in the context of this question as all dwellings will have some form of glazing.

Code 99: UNOBTAINABLE

You are unable to determine the type of glazing present within the selected dwelling.

Q48. Extent of leaded/stained windows (Specify to nearest 10%)

This question has been introduced for Historic Scotland. This question is trying to provide an estimate of the number of properties which have leaded/stained windows.

Surveyors should not include leaded double glazed windows in this measure.

Use the 10 point scale for measurement (area based)

SPECIFY: 0,55, 01-10

Code 88: Not Applicable

Not to be used in the context of this question as all dwellings will have some form of glazing.

Code 99: UNOBTAINABLE

You are unable to determine the type of leaded glazing present within the selected dwelling.

Q49. Internal window shutters

This question has been introduced for Historic Scotland. This question is trying to provide an estimate of the number of properties which have working internal window shutters.

Code 1: NONE

Code 2: LESS THAN 50%

Code 3: MORE THAN 50%

Code 4: ALL WINDOWS

Code 9: UNOBTAINABLE

You are unable to determine window shutters present within the selected dwelling.

Q50. Is glazing area typical for dwelling?

As part of the suite of additional questions on energy, surveyors are being asked to estimate whether the glazing in the dwelling is typical for the age, size and type. This then begs the question, “what is typical?” as typical changes for different dwelling types and ages of dwellings as well as size. Generally, one window per room is typical, with lounge and other rooms to the front of the dwelling having larger windows, or even bay windows. Where the lounge runs from one side of the dwelling to the other, then it would be typical for there to be a window on both sides of the lounge (or maybe even on the gable as well).

To assist, if necessary or you are in doubt, then you can use the attached tables (over the page) as the basis of your assessment. There is a table for houses and bungalows and another for flats and maisonettes. The “typical” window areas for dwellings across the different age bands and floor areas (as calculated using the RdSAP equations) are presented.

Code 0: YES

The window area is typical.

You are not expected to measure the window area to compare with this table. Using your judgement to estimate of the window area and compare this value with that in the table.

Code 1: MORE THAN (+ 25%)

The window area is **up to 25% more** than typical. This could occur through extra windows being added to a dwelling, or a window being converted into a french door or patio door.

If you use the attached tables, then the estimated window area of the dwelling is up to 25% more than the typical amount cited in the table for a dwelling of a given size and age.

If you select this option, then you do not have to measure or estimate the window areas.

Code 2: LESS THAN (-25%)

The window area is **up to 25% less** than typical. This could occur through windows in a dwelling blocked up. The more obvious situation is in flats with internal hallways and / or internal bathrooms where there is no window in these rooms.

If you use the attached tables, then the estimated window area of the dwelling is up to 25% less than the typical amount cited in the table for a dwelling of a given size and age.

If you select this option, then you do not have to measure or estimate the window areas.

Code 3: MUCH MORE THAN

The window area is **more than 25% more** than typical. The most obvious examples are dwellings with vast amounts of glazed wall area.

If you use the attached tables, then the estimated window area of the dwelling is more than 25% more than the typical amount cited in the table for a dwelling of a given size and age.

If you select this option, then you **must** to measure or estimate the window areas and include the value in the Surveyor's Notes.

Code 4: MUCH LESS THAN

The window area is **more than 25% less** than typical.

If you use the attached tables, then the estimated window area of the dwelling is more than 25% less than the typical amount cited in the table for a dwelling of a given size and age.

If you select this option, then you **must** to measure or estimate the window areas and include the value in the Surveyor's Notes.

Code 9: UNOBTAINABLE

Cannot see any possibility where you cannot make an estimate!

RdSAP "Typical" Window Areas**Total Floor Area of House or Bungalow**

NHER Age	40	50	60	70	80	90	100	110	120	130	140	150	160	170	180	190	200	210	220	230	240	250	260	270	280	290	300
pre 1919	12	13	14	15	17	18	19	20	22	23	24	25	26	28	29	30	31	32	34	35	36	37	39	40	41	42	43
1919-29	12	13	14	15	17	18	19	20	22	23	24	25	26	28	29	30	31	32	34	35	36	37	39	40	41	42	43
1930-49	12	13	14	15	17	18	19	20	22	23	24	25	26	28	29	30	31	32	34	35	36	37	39	40	41	42	43
1950-64	10	12	13	14	15	17	18	19	20	21	23	24	25	26	28	29	30	31	32	34	35	36	37	39	40	41	42
1965-75	12	14	15	16	17	18	20	21	22	23	25	26	27	28	30	31	32	33	35	36	37	38	40	41	42	43	45
1976-83	11	12	13	14	16	17	18	19	21	22	23	24	26	27	28	29	31	32	33	34	36	37	38	39	41	42	43
1984-91	11	12	13	15	16	17	19	20	22	23	24	26	27	28	30	31	32	34	35	36	38	39	40	42	43	45	46
1992-98	10	11	12	13	14	15	16	17	18	19	20	21	22	23	24	25	25	26	27	28	29	30	31	32	33	34	35
1999-2002	6	7	8	10	11	12	14	15	17	18	19	21	22	23	25	26	28	29	30	32	33	35	36	37	39	40	41
2003-2006	5	7	8	10	11	13	14	15	17	18	20	21	23	24	25	27	28	30	31	33	34	35	37	38	40	41	43
2007 onwards	5	7	8	10	11	13	14	15	17	18	20	21	23	24	25	27	28	30	31	33	34	35	37	38	40	41	43
average	10	11	12	13	15	16	17	18	20	21	22	24	25	26	27	29	30	31	32	34	35	36	37	39	40	41	43

window areas calculated from formulae set out in Table S4 of SAP 2005 Appendix S page 94, BRE (2009) The Government's Standard Assessment Procedure for Energy Rating of Dwellings, 2005 edition revision 3, Garston Watford

Total Floor Area of Flat or Maisonette

NHER Age	40	50	60	70	80	90	100	110	120	130	140	150	160	170	180	190	200	210	220	230	240	250	260	270	280	290	300
pre 1919	9	10	10	11	12	13	14	14	15	16	17	18	18	19	20	21	22	22	23	24	25	26	26	27	28	29	30
1919-29	9	10	10	11	12	13	14	14	15	16	17	18	18	19	20	21	22	22	23	24	25	26	26	27	28	29	30
1930-49	9	10	10	11	12	13	14	14	15	16	17	18	18	19	20	21	22	22	23	24	25	26	26	27	28	29	30
1950-64	10	10	11	11	11	12	12	12	13	13	13	14	14	14	15	15	15	16	16	16	17	17	17	18	18	18	19
1965-75	9	10	11	12	12	13	14	14	15	16	17	17	18	19	19	20	21	22	22	23	24	24	25	26	27	27	28
1976-83	7	8	9	10	12	13	14	15	16	18	19	20	21	22	24	25	26	27	28	30	31	32	33	34	36	37	38
1984-91	7	7	8	8	9	9	10	10	11	11	12	12	13	13	14	14	15	15	16	16	17	17	18	18	19	19	20
1992-98	7	8	9	9	10	11	12	13	14	14	15	16	17	18	18	19	20	21	22	22	23	24	25	26	27	27	28
1999-2002	5	6	7	8	10	11	12	13	14	15	16	18	19	20	21	22	23	25	26	27	28	29	30	31	33	34	35
2003-2006	5	6	7	8	10	11	12	13	14	15	16	18	19	20	21	22	23	25	26	27	28	29	30	31	33	34	35
2007 onwards	5	6	7	8	10	11	12	13	14	15	16	18	19	20	21	22	23	25	26	27	28	29	30	31	33	34	35
average	7	8	9	10	11	12	13	13	14	15	16	17	18	19	19	20	21	22	23	24	25	25	26	27	28	29	30

window areas calculated from formulae set out in Table S4 of SAP 2005 Appendix S page 94, BRE (2009) The Government's Standard Assessment Procedure for Energy Rating of Dwellings, 2005 edition revision 3, Garston Watford

Section R. External repairs

This section records the state of repair of the external fabric of the dwelling, or of the common block if the selected dwelling is a flat. This section now includes the external features (paths, paved areas etc).

The method of assessment is the same for both individual dwellings and common blocks.

VIEWPOINTS (SEE DIAGRAM R1-R23 - SELECTING VIEWPOINTS)

For the purposes of this survey, the elevation containing the main entrance to the dwelling or block is the **front**.

The elevation to the right of the front is to be assessed as the right side of the dwelling or block and the elevation to the left of the front is to be assessed as the left side of the dwelling or block. These designations are fixed from the front viewpoint and are to be carried by the surveyor to the rear viewpoint. Consequently when surveyors are standing at the back of the dwelling or block the elevation to the right is actually the left elevation (its designation from the front viewpoint) and vice versa.

Detached houses or blocks should be assessed in pairs so that all walls are assessed between the two viewpoints.

This will take the form of “**front with right**” (Code 2) and “**back with left**” (Code 5) or “**front with left**” (Code 3) and “**back with right**” (Code 6).

Mid-terraced, end terraced or semi-detached dwellings or blocks are to be assessed using the same principal to record their two or three external elevations.

Enclosed end dwellings/blocks should record their two elevations scoring VPT1 = 2 or 3, VPT2 = 8.

Corner dwelling/block viewpoints should be front and rear only.

Enclosed mid dwellings/blocks have only one viewpoint and should be scored VPT1 = 1, VPT2 = 8.

Where more than two-thirds of an attached flank wall(s) is exposed (O1 Codes 2 or 3) surveyors should choose their viewpoint to include this wall(s) and survey the dwelling or block as if it were detached or semi-detached/end terrace.

Where less than two-thirds of an attached flank wall(s) is exposed (O1 Code 1) surveyors should disregard that wall when selecting their viewpoints. However, any disrepair to an attached flank wall, which is less than two-thirds exposed, should be transposed and recorded fully against either the front or rear elevation.

NOTE: Not all elements will be immediately visible from the selected theoretical viewpoints but surveyors are expected to move round the building to make their assessment of those elements.

Having selected the appropriate viewpoints, surveyors should circle the corresponding codes at the top of Section R (on the list of codes and on the viewpoint selection diagram) and enter those codes into the

VIEWPOINT boxes at the top of the two repair columns.

Where the selected dwelling is a flat and Section R is being completed for the common block, questions **R14 - R18** are to be **assessed** against the **selected dwelling only** and **not against the common block**.

Surveyors should undertake the following sequence in their inspection of the external elements.

Select and record the relevant viewpoint.

For each viewpoint selected....

- ...determine the presence of a defect and record the level of disrepair in line with the repair scoring methodology for the element being assessed;
- ...consider if the action required to remedy any disrepair is urgent and record opinion or if there is no disrepair then determine whether maintenance is urgent or normal;
- ...assess and record the residual life of the element after any disrepair has been remedied or the residual life of the whole element if there is no disrepair.

DIAGRAM R1 – R23: SELECTING VIEWPOINTS

SELECTING VIEWPOINTS

(Flats only : survey party wall as seen inside)

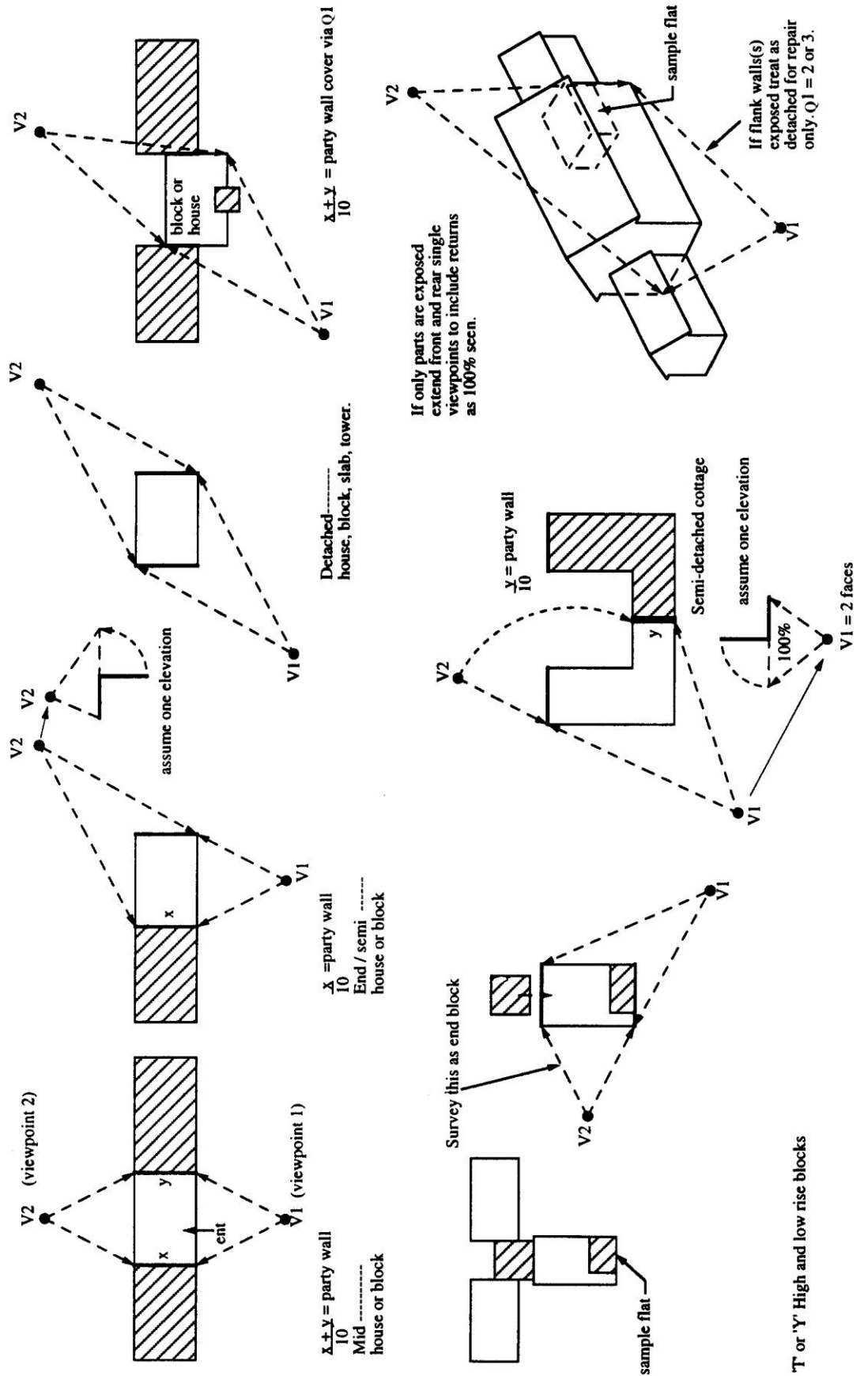

T or 'Y' High and low rise blocks

Surveyors should undertake the following sequence in their inspection of the external elements or groups of elements:

- Identify the element/group (in isolation)
- Determine the whole extent of the element/group;
- Determine the presence of any disrepair;
- Assess the extent of that disrepair as a proportion of the whole element;
- Record the level of disrepair in the 10 point scale;
 - if there is disrepair then consider if the action required to remedy any disrepair is urgent or non urgent;
 - if there is no disrepair then consider if the maintenance is urgent or normal.
- Assess the residual life of the element **after** any disrepair has been remedied or if there is no disrepair the residual life of the element.

Surveyors must undertake their assessment of each element in isolation. The surveyor must not take account of associated work to other elements.

The systems used by the Scottish Government to establish the cost of work has an in-built allowance for the cost of associated work and therefore recording associated work separately, where it is not justified in its own right, will result in an over-estimation of costs.

The surveyor's assessment of the area of the element in disrepair can either reflect **one occurrence** or a defect or **the aggregate area of two or more defects**.

REPAIR SCORES

Section R records the presence of disrepair to 23 elements, or groups of elements, that form part of the external fabric and elements of a dwelling or block.

The evaluation and recording of repair scores follows the standard 10 point methodology described earlier. Therefore:

Code "00"	- represents an element(s) in good repair requiring no remedial work
Code "55"	- covers repairs less than 5%;
Code "01"	- covers repairs in the range 5% to less than 15%;
Code "02"	- covers repairs in the range 15% to less than 25%;
Code "03"	- covers repairs in the range 25% to less than 35%;
Code "04"	- covers repairs in the range 35% to less than 45%;
Code "05"	- covers repairs in the range 45% to less than 55%;
Code "06"	- covers repairs in the range 55% to less than 65%;
Code "07"	- covers repairs in the range 65% to less than 75%;
Code "08"	- covers repairs in the range 75% to less than 85%;
Code "09"	- covers repairs in the range 85% to less than 95%;

- Code "10" - represents disrepair requiring renewal of 95% or more;
- Code "88" - not applicable; the element does not exist on that viewpoint
- Code "99" - unobtainable; the element exists on the viewpoint but the surveyor is unable to assess disrepair for that element

IS THE REPAIR URGENT?

Surveyors are required to determine whether repairs recorded to be done urgently. Where no disrepair is recorded then an surveyors will need to assess whether normal or urgent maintenance is required. This is a change from the previous surveys where urgency was classified as not applicable for no disrepair. This change is to address the requirements of Historic Scotland with regard to building maintenance.

Urgent repairs are: those elements associated with keeping the building envelope in a wind and weather tight condition. If left unattended, these repairs will result in a further deterioration in the fabric of the block/dwelling; or

those associated with the health, safety or wellbeing of the occupants of the block/dwelling.

Non urgent repairs: those elements in disrepair which are not considered to be urgent

Urgent Maintenance: elements not in disrepair (score 00) but requiring to be maintained urgently.

Normal maintenance: the norm for elements not in disrepair

Not Applicable: those elements which do not exist.

RESIDUAL LIFE

Surveyors are required to estimate the residual life of an element assuming that any disrepair recorded at the REPAIRS column is repaired immediately. This estimate is to be made for the whole element and not just that part of it that may require repaired. The answer code used should reflect the number of years that will elapse before the replacement of the element(s) becomes the only sensible option. This will normally represent the residual life of that portion of the element(s) that does not require repair at this time.

NOTE: If an element, or group of elements, has a different residual life when assessed from each viewpoint, **the shorter residual life** should be recorded.

EXPECTED LIFE OF MATERIALS/ELEMENTS

The following list is derived from Life Expectancies of Building Components published by the RICS in August 1992, and it is provided as guidance on the expected life of materials/elements when first installed. This list should only be used as an aid in the surveyor's assessment of residual life as many factors will contribute towards the life expectancy of a material/element.

It is crucial that the surveyor's assessment of the residual life of an element/material should be derived from a review of its condition in conjunction with its expected life. For example because a softwood window is 25 years old does not automatically mean that it should be replaced.

NOTE: Surveyors should assume that normal maintenance is undertaken in their assessment of the residual life of elements.

R1, R3 , R9, R11, R13 and R19 to R23 are not assessed for residual life

QUESTION	MATERIAL/ELEMENT	EXPECTED LIFE (Years)
R2	Principal roof covering	Pitched
		Slate natural 80
		Slate artificial 40
		Stone 100
		Tiles clay 60
		Tiles concrete 43
		Metal 25-30
		Ridges
		Mortar bedded tile 30
		Dry systems 25
		Flat
		3-layer-felt 14
Single coat asphalt 25		
Single coat elastomeric 15		
R4	Secondary roof covering	Pitched
		Slate natural 80
		Slate artificial 40
		Stone 100
		Tiles clay 60
		Tiles concrete 43
		Metal 25-30
		Ridges
		Mortar bedded tile 30
		Dry systems 25
		Flat
		3-layer-felt 14
Single coat asphalt 25		
Single coat elastomeric 15		
R5	Chimney stacks	50
R6	Flashings	Lead 60
		Dry systems 25
		GRP 25
		Felt 10
		Cement 10
		Asbestos cement 29
		Mortar 20
R7	Roof gutters and downpipes	Cast iron 50
		Aluminium 33
		Plastic 25

		Asbestos cement	25
		Lead valley gutters	55
		Zinc	20
R8	Soil waste and vent pipes	Cast iron	50
		Plastic	25
R10	Wall finish	Facing brick	100
		Engineering brick	100
		Stone	100
		Block	50
		Hanging tiles	50
		Weather boarding	28
		Mortar	50
		Render	35
R12	DPC		30+
R14	Private balcony to dwelling		30+
R15	External doors to dwelling	Hardwood	50
		Softwood painted	30
		Softwood microporous paint	28
		Softwood stained and varnished	25
		UPVC	30
		Galvanised steel	40
R17	External paint to dwelling		5
R18	External stairs to own door		30+

COMBINATIONS OF SCORES ALLOWED IN SECTION R

The table below outlines **all** possible combinations of scores in Section R.

REPAIRS VIEWPOINT 1	REPAIRS VIEWPOINT 2	URGENCY	RESIDUAL LIFE
"00"	"00"	"3" or "4"	"1", "2", "3" or "4"
"Any"	"55" or "01" – "10"	"1" or "2"	"1", "2", "3" or "4"
"01" to "10", "55"	"Any"	"1" or "2"	"1", "2", "3" or "4"
"00"	"88"	"3" or "4"	"1", "2", "3" or "4"
"88"	"00"	"3" or "4"	"1", "2", "3" or "4"
"00"	"99"	"3" or "4"	"1", "2", "3" or "4"
"99"	"00"	"3" or "4"	"1", "2", "3" or "4"
"88"	"88"	"8"	"8"
"88"	"99"	"9"	"9"
"99"	"88"	"9"	"9"
"99"	"99"	"9"	"9"

R1. Principal roof structure

The principal roof structure is the structure to the principal roof type identified at Q19

Surveyor's should form a view on the nature of the roof structure and assess any disrepair to rafters, roof timbers or other structural components as a percentage of the total visible from each viewpoint.

The following conditions can be indicative of disrepair:

- sagging of roof structure indicated by ponding;
- humping of the roof over internal load bearing walls and/or party walls;
- spreading outwards of the roof structure at the eaves. This may be accompanied by signs of cracking or distortion at the top of the supporting walls.

NOTE: Any slight sagging of the roof structure that has occurred due to the initial settlement of the dwelling or block should be discounted here.

No disrepair (00) is expected to have normal maintenance (4) here.

R2. Principal roof covering

The principal roof covering is the covering to the principal roof type (Q19). Surveyors should assess any disrepair to the principal roof covering as a percentage of the total area visible, from each viewpoint.

This assessment is made on an area basis and should include:

- missing, broken or slipped slates or tiles;
- torn or cracked flat roof coverings.

NOTE: Paint to corrugated roof sheets, whether bituminous or otherwise, does not score as part of the roof covering.

An example of urgent maintenance would be moss which may be starting to lift the roof covering.

R3. Secondary roof structure

The secondary roof structure is the structure to the secondary roof type.

The secondary roof type is that part of the roof left (or the roof type forming the greater part of that left where there are three or more roof types) after the principal roof type has been identified.

Surveyor's should form a view on the nature of the roof structure and assess any disrepair as a percentage of the total visible from each viewpoint.

The following conditions can be indicative of disrepair:

- sagging of roof structure indicated by ponding;
- humping of the roof over internal load bearing walls and/or party walls;
- spreading outwards of the roof structure at the eaves. This may be accompanied by
- signs of cracking or distortion at the top of the supporting walls.

NOTE: Any slight sagging of the roof structure that has occurred due to the initial settlement of the dwelling or block should be discounted here.

Where no disrepair (00) is scored then normal maintenance (4) is expected to be recorded.

R4. Secondary roof covering

Surveyor's should assess any disrepair to the secondary roof covering (identified at Q24) as a percentage of the total area visible, from each viewpoint.

This assessment is made on an area basis and should include:

- missing, broken or slipped slates or tiles;
- torn or cracked flat roof coverings.

NOTE: Paint to corrugated roof sheets, whether bituminous or otherwise, does not score as part of the roof covering.

An example of urgent maintenance would be moss which is starting to lift the roof covering.

R5. Chimney stacks

NOTE: In order to avoid double counting, surveyors must ensure that individual chimney stacks are only assessed from one viewpoint. This means that tall chimney stacks, those located along the ridge line or those otherwise visible from the two viewpoints selected should only be assessed and recorded from one of those viewpoints. This should not prevent surveyors from assessing the total provision of chimneystack in the dwelling or block from both viewpoints.

The different components within "**Chimney Stacks**" have the following percentages of the whole attributed to them:

- Cope 10%
- Structure 60%
- Finish 15%

- Pots 15%

This assessment should include:

- broken, unseated or unsafe pots;
- leaning stacks;
- unsafe chimney heads;
- decayed brick/masonry structure; and
- defective pointing.

Where no disrepair (00) is scored then normal maintenance (4) is expected to be recorded.

R6. Flashings

NOTE: Flashings are defined in this survey as all edges to roof coverings.

This assessment is made on a linear basis as a percentage of the total visible from each viewpoint and should include:

- detached flashings;
- loose cement fillets;
- missing, broken or slipped ridges or hips;
- damaged verges; and
- damaged eaves boardings or fascias.

R7. Roof gutters and downpipes

This assessment is made on a linear basis as a percentage of the total visible from each viewpoint and should include:

- cracked or corroded gutters or downpipes;
- loose or defective brackets;
- missing fittings.

Guttering requiring to be re-levelled should be scored “55” and not urgent.

Choked gutters (not in disrepair) which display signs of affecting the fabric of the dwelling (staining of wall due to overflowing gutters) should be scored as urgent maintenance (3) otherwise normal maintenance (4) is expected for no disrepair.

R8. Soil, waste and vent pipes

This assessment is made on a linear basis as a percentage of the total visible from each viewpoint and should include:

- cracked soil, waste and vent pipes, including internal SVPs;

- loose or defective brackets;
- missing fittings.

Missing birdcages would be an example of urgent maintenance (3) otherwise no disrepair (00) is expected to have normal maintenance (4) here.

R9. Wall structure

Disrepair to the wall structure should be assessed on an area basis as a percentage of the total visible from each viewpoint.

The following conditions are indicative of disrepair to the wall structure:

- vertical or diagonal cracking due to differential settlement;
- cracking or distortion in the walls due to differential movement (movement between different components of the building due to thermal effects, inadequate expansion joints or inadequate fixings between components);
- cracking of horizontal mortar joints at regular vertical intervals or bowing of the outer leaf of the wall due to wall tie corrosion and/or failure;
- slipped or loose cladding panels;
- twisted, cracked or slipped lintels due to settlement, differential movement, deterioration of the material of the lintel or overloading;
- expansion of mortar, bowing of walls and over sailing of walls at DPC level due to sulphate attack in the brickwork;
- deterioration of any structural material leading to cracking slipping or distortion of the walls;
- exposure of reinforcing materials;
- cracks due to design defects;
- carbonation fractures.

Where no disrepair (00) is scored then normal maintenance (4) is expected to be recorded.

R10. Wall finish

Disrepair to the wall finish should be assessed as a percentage of the total visible from each viewpoint. This should be undertaken against all the wall finishes visible (principal, secondary etc.) even though it is only the principal wall finish that has its composition identified.

For the purposes of this survey wall finish is defined as:

- **pointing** to fair faced masonry, brickwork or blockwork (Q5 Codes 2, 3 and 5);

NOTE: If pointing deteriorates to such an extent that it effects the structural integrity of the wall surveyors should record it as a

structural defect at R9.

- a coating applied to the wall structure including all renders, pebble dash and similar proprietary surface treatments (Q5 Code 1). It is not important whether or not these surfaces have been painted;
- ship-lap timber, shingles etc applied to a structural frame (Q5 Code 4);
- clay or concrete tiles mechanically fixed to wall structure;
- brick slips or mosaic tiles applied to concrete panels (Q5 Code 6);
- all forms of plastic, laminates, thin metal sheets (Q5 Codes 7 and 8).

NOTE: Do not include masonry paint in this assessment.

Where no disrepair (00) is scored then normal maintenance (4) is expected to be recorded.

External masonry decoration to wall finish should be ignored. An example of urgent maintenance is graffiti

R11. Foundations

This assessment is made on a linear basis as a percentage of the total visible from each viewpoint:

Foundation failure is normally indicated by vertical or diagonal cracking to the wall structure.

Some wall structure repair would normally be expected if surveyors are scoring disrepair to foundations.

Where no disrepair (00) is scored then normal maintenance (4) is expected to be recorded.

R12. Damp proofing course (DPC)

Where surveyors have undertaken an internal inspection they should have noted evidence of rising damp and should now use this to help in their assessment of the state of repair of the DPC.

DPCs should be assessed on a linear basis.

Where no disrepair (00) is scored then normal maintenance (4) is expected to be recorded.

R13. Underground drainage

The assessment of the underground drainage is made on a linear basis and should include defective:

- manhole or rodding eye covers;

- gulleys;
- branches.

NOTE: Surveyors should not attempt to lift manhole covers.

Choked gulleys would be an example of urgent maintenance (3) otherwise where no disrepair (00) is scored then normal maintenance (4) is expected to be recorded.

Note on R14 to R18

Questions R14- R18 only apply to the element(s) that belong to the dwelling selected for survey (house or flat).

R14. Privately balcony to dwelling

The assessment of private balconies should include the:

- deck finishes and substrate;
- structural supports;
- railings;
- drainage and drainage outlets;
- waterproof finishes;
- skirtings.

Choked (but undamaged) gulleys or drainage outlets would be an example of urgent maintenance (3) otherwise where no disrepair (00) is scored then normal maintenance (4) is expected to be recorded.

R15. External doors to dwelling

These are the doors to the dwelling being surveyed, not the common block doors which are recorded in Section P.

The different components within “External doors to dwelling” have the following percentages of the whole attributed to them:

- Door 30%
- Frame 50%
- Ironmongery 20%

The assessment of the external door should include:

- distorted door panels;
- badly hung door panels;
- defective ironmongery;
- damage to glazed door panels, side lights or lunettes;

- damaged or defective seals.

NOTE: French windows (hinged) should be assessed as doors (if they form a pair count as two). However sliding patio doors should be assessed as windows.

An example of urgent maintenance would be a single cracked glazing pane on external doors or door panels which could potentially allow water ingress.

R16. Windows to dwelling

The different components within “Windows to dwelling” have the following percentages of the whole attributed to them:

- Frame 50%
- Glazing 30%
- Ironmongery 20%

Therefore, the replacement of all of the glazing will be recorded as "03" while the replacement of half the frame will be recorded as "02" or "03".

The assessment of windows should include:

- distorted window frames;
- rotted cills or sub cills;
- broken panes of glass;
- corroded, rusting or rotten ironmongery;
- defective, damaged or missing seals or putty;
- defective seals in double or triple glazing units resulting in condensation occurring between the panes of glass within the glazing unit.

An example of urgent maintenance (3) would be a cracked glazing panes on external windows which could potentially allow water ingress.

R17. External paint to dwelling

Surveyors should assess the paintwork to all external windows, doors, timber components, rhones and rainwater goods etc. This definition should include stains and varnishes.

Disrepair to external paintwork is primarily assessed upon an area basis. However surveyors should include within this assessment the level of preparatory work (rubbing down, burning off etc) that will be required.

Where all the painterwork has to be replaced with a full paint specification of burning off, rubbing down, primer, undercoat and finish then that would score a 10.

Where all the painterwork has to be repaired with rub down, undercoat and/or finish then that would score a maximum of 05.

Surveyor's assessment of the proportion should be based on the above criteria.

Where a dwelling has plastic windows, doors, fascias etc the surveyor should use "88" (Not applicable).

NOTE: Do not include masonry paint in this assessment.

Where no disrepair (00) is scored then normal maintenance (4) is expected to be recorded.

R18. External stairs to own door

NOTE: This question is applicable for 4-in-a-block and converted houses only.

This assessment should include flights, treads, nosings and handrails.

The different components of the stairs have the following percentages of the whole attributed to them:

- Risers and goings 50%
- Stringers 30%
- Handrails 20%.

Therefore, the replacement of about half of the risers and goings in a staircase will be recorded as a "02" or "03".

Note on R19 to R23

Questions R19-R23 replaced the old Section S in 2010. Surveyors should note that they are now expected to score the external elements from both viewpoints rather than make a whole dwelling assessment.

This should provide additional data on the distribution of disrepair around the dwelling as well as provide a finer level of detail of disrepair.

Disrepair assessment to all external elements is now carried out using the 10 point scale of disrepair scoring. The recording of urgency is now included but there is no requirement to determine residual life for any of these elements.

R19. Boundary fences, walls and gates

Assessment is made on a linear basis.

Surveyors should not take account of variation of wall/fence type when making their assessment of disrepair.

Where no disrepair (00) is scored then normal maintenance (4) is expected to be recorded.

R20. Paths, paved areas, ramps

Surveyors should assess both the surface finish and the structure of all paths, paved areas or ramps associated with the dwelling or common block and within the curtilage of the dwelling or common block

Assessment is made on an area basis.

Surveyors should not attempt to assess the public footpaths.

Examples of urgent maintenance (3) would be uneven levelling but unbroken slabbing or extensive vegetable growth in the gaps of slabbed areas. Otherwise, where no disrepair (00) is scored then normal maintenance (4) is expected to be recorded.

R21. Attached garage

NOTE: This does not include integrated or separate garages.

Surveyors should assess the surface finish and structure and any doors or windows of any attached garages.

Assessment is made on an area basis broken down as follows:

- Roof 45%
- Walls 45%
- Doors/Windows 10%

An example of urgent maintenance (3) would be a cracked glazing panes on external windows which could potentially allow water ingress or choked gutters which is shown by moisture staining on the walls. Otherwise, where no disrepair (00) is scored then normal maintenance (4) is expected to be recorded.

R22. Steps and plats

Surveyors should assess both the surface finish and the structure of any step or plats to both front and rear entrance doors assessed in D4.

Assessment is made on an area basis.

Examples of urgent maintenance (3) would be uneven levelling but unbroken steps or extensive vegetable growth in the gaps of slabbed areas. Otherwise, where no disrepair (00) is scored then normal maintenance (4) is expected to be recorded.

R23. Surface drainage

Assessment is made on an area basis.

Surveyors should assess any falls and gulleys associated with surface drainage.

Where the **natural drainage** (no installed surface water drainage system) is **obviously working** and there is **no ponding** or obvious signs of water **damage** then the drainage should be **scored as no repair (00)**.

If **no drainage is installed** and there are **obvious problems** connected to the **lack of drainage** then surveyors must score **not applicable (88)**. Surveyors should be aware that the lack of the amenity (score 88) means that the surface water drainage will be installed as an improvement, not a repair.

Choked (but undamaged) gulleys or drainage channels would be an example of urgent maintenance (3) otherwise where no disrepair (00) is scored then normal maintenance (4) is expected to be recorded.

Section S.

This section is intentionally blank

Section T. Tolerable Standard and Statutory Action

NOTE: For full Scottish Government documentation to the Tolerable Standard refer to Part 11 of this manual.

For the purposes of this survey all dwellings, in both the private and public sectors, are to be considered on the same basis for all questions, including statutory action.

Some of the items in this section are linked to the assessments made earlier on, in Section H. As such, your answers to these items below should be used as aides memoire when completing this section:

- H3 - relates to T1 (Is the dwelling structurally stable?)
- H5, H6, H8 & H9 - relates to T3 (Has the dwelling satisfactory provision for natural and artificial light, for ventilation and for heating?)
- H10 & H11 - relates to T2 (Is the dwelling substantially free from rising or penetrating damp?)

Refer to Section T and Part 3, item 3.2.1, for details of the tolerable standard

The Tolerable Standard is defined in Section 86(1) of the Housing (Scotland) Act, 1987 and amended by the Housing (Scotland) Act 2001, Housing Scotland Act 2006.

The guidance in this section includes extracts from The New Scottish Housing Handbook Bulletin 2, Scottish Development Department, HMSO 1969. For the purpose of this survey supplementary guidance notes have been added in bold to some of these comments.

NOTE: The “house” as used by the Act can be taken to mean any form of dwelling.

Note on T1 to T12

The requirements of the Tolerable Standard, as shown on the survey form, are to be assessed on a YES or NO basis.

Code 1: YES

This requirement is above the Tolerable Standard. The dwelling **is not BTS**.

Code 2: NO

This requirement is Below the Tolerable Standard. The dwelling **is BTS**.

Code 9: UNOBTAINABLE

This answer code is only acceptable when you are undertaking an external survey (B1 Code 2) or a dwelling description (B1 Code 3).

NOTE: FAILURE ON ANY ONE ITEM MAKES THE WHOLE DWELLING BTS.

T1. Is the dwelling structurally stable?

The tolerable standard has always included the requirement for houses to be structurally stable. The Housing (Scotland) Act 2006 did not change this element of the standard.

Evidence of instability is likely to be significant insofar as it indicates the likelihood of further movement that could be a danger to the occupants of the dwelling.

When assessing a house against this element of the tolerable standard, surveyors should look for visible signs of potential instability in any structural element of the building. This will allow the surveyor to consider the stability of the building as a whole.

In reaching a decision you should have regard, amongst other things, to:

- the stability, distortion or spreading of roof structures;
- the stability of chimneys, dormers, parapets or other roof features;
- the stability, eccentricity and fracturing of walls and the effectiveness of cavity ties;
- the structural adequacy of horizontal elements such as floors, stairs, ceiling and balconies;
- the structural effectiveness of foundations, footings and slabs;
- the structural effectiveness of framed structures and non-load bearing panels.

For more detailed information refer to Part 11 of this manual.

T2. Is the dwelling substantially free from rising or penetrating damp?

The tolerable standard as first defined in the Housing (Scotland) Act 1969 and has always included the requirement for a dwelling to be substantially free from rising and penetrating damp. The Housing (Scotland) Act 2006 does not change this but changes the assessment criteria.

Not all dampness need be significant; e.g. a small patch caused by defective pointing would probably not give grounds for action under this item. What does matter is likely to arise from the lack of a proper damp-proof course leading to persistent visible rising damp or a major water penetration to the wall or ceilings caused by a failure of roof covers or flashings. Surveyors should review the Internal room assessment at H10 and H11.

FAILURE DUE TO RISING DAMP

Definition: Is the vertical movement of moisture from the ground into the fabric of a building. This can affect any part of the building in contact with the ground, the most obvious being walls and floors. Rising damp will not normally rise higher than around 1.2m above ground level.

In cases of rising damp, the presence of visible indicators of rising damp (see pp 27/28 of Part 11 of this manual) inside a dwelling usually mean that the problem is of a persistent nature. It will not improve without action, and could over time affect the structural stability of the dwelling and health of the occupiers.

Failure: The presence of any visible indicators of persistent rising damp in any room will normally mean that the dwelling is below tolerable standard.

Surveyors should use the undernoted indicators to determine the presence of rising damp:

- Darkened colouring of external bricks or stonework;
- Moss growing near the bottom of the wall, but above the DPC;
- Crumbling of the surface finish of stonework close to the ground;
- Deterioration of interior wall fabric and finishings
- Discolouration of paintwork or wallpaper, normally in a regular pattern such as an almost horizontal tidemark;
- Soft, flaking or bubbling plaster on lower wall surfaces;
- Flaking and bubbling paintwork on lower wall surfaces;
- Loose wallpaper on lower wall surfaces;
- Skirtings affected by rot;
- Aware of a dank moist smelling atmosphere in the room that could be coming from damp carpets, bed covers or mattress - use this as an indication that there may be a damp problem in the room and seek to find the source and cause of such a dampness problem;
- Look for fungi growth in all rooms, for example on walls, carpets etc. This may indicate that there is a damp problem, or it may be the result of rot or other causes of dampness;
- Wood showing discoloration and may be crumbling or deteriorating may be affected by rot;
- Boards failing to support weight when walked on / dampness affecting carpet.

Supporting evidence for rising damp may be found with:

- some older dwellings were built without a DPC (and may not suit one);
- basements converted into living accommodation may be below the DPC line;

- chimneys and hearth areas may not have a DPC and be more susceptible to rising damp problems;
- look to see if the ground level is raised next to the wall;
- presence of spoil material against the base of the wall;
- retaining walls may be supporting earth and this can bridge the DPC;
- deep structural cracks that may affect the damp proof course;
- deterioration of the waterproof barrier may allow water to rise unhindered into the building fabric;
- inappropriate repair to DPC and/or lower structures of dwellings with no DPC may allow rising damp to occur.

FAILURE DUE TO PENETRATING DAMP

Definition: Is moisture which enters a dwelling from outside because of a defect in part of its structure. There may be defects in the roof, the exterior walls, rainwater gutters and down-pipes, or missing flashings. The source of persistent penetrating damp can be difficult to identify because there may be no consistent pattern to the signs. For example, damp patches may appear in more than one room, and be located in different parts of the room.

In cases of penetrating damp, the presence of visible indicators of penetrating damp (see pp 29/30 of Part 12 of this manual) are indicated below.

Failure: A dwelling will normally be below tolerable standard if a surveyor finds persistent visible penetrating damp which covers an area greater than approximately:

- 10% of the overall wall space in one apartment (habitable room) in the dwelling;
- or** 10% of the ceiling in one apartment (habitable room) in the dwelling;
- or** 20% of overall wall space or ceiling in one or more other spaces in the dwelling.

Surveyors should use the undernoted indicators to determine the presence of penetrating damp:

- discoloured or darkened damp patches on any part of the walls of the dwelling;
- any noticeable deterioration in the outward appearance of the brick or stonework;
- moss growth in a line down the wall, possibly below a plumbing overflow or defective guttering, indicates a persistent damp problem;
- both walls and ceilings can be affected by penetrating damp;
- there may be an obvious damp patch because the walls or ceilings are discoloured;

- wallpaper may be loose or bubbling, and paintwork can also deteriorate and flake off in the affected area;
- plaster can deteriorate and lose its structure, feeling soft to the touch or be bossed;
- examine the internal roof-space for evidence of water penetration;
- wooden roof structures, including beams and supports, may be affected by rot
- may affect structural stability
- any bad or musty smell in the room be coming from damp carpets, bed covers or mattress
- an indication that there may be a damp problem in the room
- seek to find the source and cause of such a problem.

Supporting evidence for penetrating damp may be found with:

- crumbling, loose or missing pointing and render may allow water to pass into the interior fabric of the building;
- Inappropriate repair using cement mortar may force water into the fabric of the building;
- cracks in exterior walls may let or draw water enter the internal fabric;
- look for damaged, displaced or missing tiles on the roof;
- damaged flashings may allow water to seep underneath and into the internal fabric;
- damaged, missing or displaced guttering or down-pipes may deflect excessive amounts of rainwater onto the exterior walls.

Guttering that is blocked with leaves, moss, silt or vegetative growth will not be able to adequately manage the rainwater. This is a maintenance issue and is unlikely to be used to declare a dwelling below the tolerable standard.

NOTE: Where both walls and ceilings are affected, if the sum of the two affected area proportions is 10% or more then the dwelling could be deemed to be below tolerable standard.

If the dwelling fails either or both of these elements then the dwelling is below tolerable standard.

For more detailed information refer to **5.1 to 5.28 in Part 12** of this manual.

T3. Has the dwelling satisfactory provision for natural and artificial light, for ventilation and for heating?

The tolerable standard as first defined in the Housing (Scotland) Act 1969 and has always included the requirement for a dwelling to have satisfactory light, ventilation and heating. The Housing (Scotland) Act 2006 does not change this but the failure criteria have changed.

Natural & artificial lighting:

Natural lighting is daylight that enters the dwelling, normally through the windows. The amount of light that enters the dwelling is dependent on the size and number of windows. It can also be affected by shading caused by other buildings or objects outside the window.

Artificial lighting generates light inside the dwelling and is normally, but not always, powered by the electric supply.

Ventilation is the exchange of air inside the dwelling with fresh air outside. Ventilation is an essential factor in controlling the moisture content of the air inside the home and helps prevent the occurrence of condensation. The most obvious method of ventilation is opening a window. Others include mechanical extractor fans, air vents and ventilation via fireplaces.

A dwelling needs to be able to provide heating for the occupants. A dwelling that has no means of heating is likely to present a risk to the health of the occupants. The majority of dwellings in Scotland have central heating systems, most of which use gas or electricity. Other forms of heating include oil fired range cookers, solid fuel fires and electrical heaters.

No preference need, in general, be shown for any particular form of heating; but a serious view should be taken of lack of either a working flue for a coal or gas fire or a 13/15 Amp power point from which electric heating could be worked.

Is there satisfactory provision for natural light in all apartments?

Surveyors should ensure that all habitable rooms in a dwelling have a satisfactory level of natural lighting. A simple way to judge whether there is satisfactory provision for natural lighting is to consider the ratio of the combined surface area of the windows against the floor area of the room.

As a guide, each habitable room should normally achieve a ratio of at least 1:20. In other words, the surface area of the window should be at least one twentieth of the floor area. We present this ratio as a guide to assist surveyors alongside their professional judgement. We do not expect surveyors to routinely take precise measurements of window and floor areas.

Other factors might also influence the amount of natural light entering an apartment. For example, an apartment might achieve a ratio of 1:20 or greater, but receive little natural light during daytime because an adjacent building or structure outside the dwelling obstructs the amount of light entering the apartment. In other cases, the position of the window(s) in relation to the overall dimensions of the apartment may mean it is unsatisfactory.

Ignoring occupant behaviour not within the scope of the assessment:

Sometimes the occupants of the dwelling will use a normally habitable room for an alternative purpose, such as a photographic dark-room, and it may not have satisfactory natural lighting. In these cases – the dwelling should not normally be scored below tolerable standard.

Surveyors may occasionally find that a very small room (possibly non-habitable room) with no natural light or ventilation, often referred to as a “box-room”, is being used as a

bedroom by the occupants of the dwelling. This type of situation relates to the way the occupants are using the dwelling as opposed to a specific deficiency in the dwelling itself, and so is not within the scope of the tolerable standard.

Is there satisfactory provision for artificial lighting?

Every habitable room in a dwelling, plus a bathroom, toilet, kitchen, utility, and all circulation areas, should have provision for permanently-fixed artificial lighting to allow the occupants to carry out normal domestic activities in safety and comfort. This will usually take the form of a wall light switch which controls an electric light on the ceiling or wall.

A very small number of dwellings are not connected to the mains electric supply, or have a private generator, and may have alternative fittings, such as gas mantle type artificial lighting.

Surveyors do not need to measure the amount of light that the system is capable of delivering, rather that the occupants are able to use this to light their home should they choose.

Occupants may opt to use alternative light sources, such as table lamps or candles, but the dwelling should nonetheless have provision for fixed and permanent artificial lighting.

Surveyors should use his/her judgement to decide on each case if the provision for artificial lighting is satisfactory.

Is there satisfactory provision for ventilation?

It is essential that all dwellings have provision for ventilation so that the occupants are able to properly manage the environment within their home. Unsatisfactory ventilation is a major contributing factor to the occurrence of condensation in dwellings, and can also lead to hygiene problems.

All habitable rooms, plus the kitchen, should have provision for ventilation. Surveyors should use his/her judgement to decide if the provision for ventilation is satisfactory for each individual room.

The most obvious method of ventilating a room is to open a window. For an apartment with a window, a surveyor should consider the ratio of the window opening against the floor area. As a guide, the ratio should normally be at least 1:40 opening to floor area. As with natural light, surveyors should use the ratio as a guide alongside their professional judgement.

Where the ratio does not meet 1:40, surveyors should also take account of the presence of other forms of ventilation such as air vents, open fireplaces and doors which might provide additional air changes in the apartment.

A window that provides ventilation should open directly to the outside and not into an adjacent apartment, circulation space or common access route, such as a tenement close.

For bathrooms, and other apartments, plus the kitchen, where there is no satisfactory openable window, they must have an alternative ventilation system. Normally this will be a mechanical device, such as an extractor fan, but in some cases a surveyor will find other systems such as a passive stack type (where warm, moist air passes through

a vent into an almost vertical duct and is expelled at an outlet on the roof). The device or system must vent directly to the outside and not into an adjacent apartment, circulation space or common access route, such as a tenement close.

It is not essential for surveyors to test if a device is working as this is not practical at the time of the visit. But he/she should be satisfied that it is fit for purpose and not broken or damaged to such a degree that it cannot be used and is beyond economic repair. If the surveyor considers the cost of repairing the device is disproportionate to the cost of replacement, the dwelling is below tolerable standard.

T4. Has the dwelling an adequate piped supply of wholesome water within the dwelling?

Every dwelling should have an adequate supply of wholesome water. An unwholesome water supply can cause significant and long-term health problems for occupants.

Local authorities have rarely used the wholesome water criterion of the tolerable standard as a basis for taking statutory action. Local and national dwelling condition surveys have not routinely examined water quality. This may be because surveyors have focused on more obvious problems in the dwelling, such as dampness or instability.

It also reflects a lack of guidance on water quality issues for surveyors or the specialist nature of testing wholesomeness.

The supply must be available to at least one tap at the sink. The supply must not be intermittent and must not be polluted. It must be within the dwelling.

In reaching a decision, the surveyor should have regard to:

- the adequacy of private supplies;
- the siting of this supply must be within the dwelling and should normally but not necessarily be at the kitchen sink;
- the route from the mains to the drinking tap should not be via a storage tank of an unsuitable type / condition. Stored supplies to the sink (as used in multi-storeys) must be both covered and vented;
- for the purposes of the survey the absence or presence of lead pipe is not a consideration under this item. Lead pipe work is recorded at L8 and L9;
- water doesn't have to be crystal clear to be satisfactory - some discolouration can occur within satisfactory drinking water.

T5. Has the dwelling a sink provided with a satisfactory supply of both hot and cold water within the dwelling?

A dwelling meets the tolerable standard if it has a sink provided with a satisfactory supply of both hot and cold water within the dwelling

This item has been defined as objectively as possible. The emphasis is placed not on the means of heating the water but on the availability of a supply that is adequate to the needs of the dwelling. It must be within the dwelling.

Definition of Sink:

This refers to any type of fixed sink, permanently connected to an appropriate drainage pipe. The purpose of a sink is distinct from that of a wash-hand basin. A sink is used mainly for cleaning food during preparation, and for washing dishes and utensils used to prepare and consume food.

Satisfactory supply of hot & cold water:

The sink should have a fixed tap or taps capable of delivering both hot and cold water. The water may emerge from two separate taps or from a single mixer type tap. A hot water storage tank, or an instantaneous water heater, will normally provide the hot water. An independent hot water heater with storage of less than 7 litres is to be regarded as BTS.

If the water heating device is broken or damaged, and the surveyor believes it is not fit for purpose and beyond economic repair because of its age and type, the dwelling is below tolerable standard.

The presence of a condemned notice on a boiler, or information from the occupier on how long the water heating device has been broken may be helpful to a surveyor in making this judgement. However, if a surveyor considers that the device can be repaired and thinks that this will be done soon after the visit, the dwelling is not below tolerable standard

Location:

It is important that the sink is located within the main living part of the dwelling. The occupants should not need to go outside to access it and it should not be located in an out-dwelling or garden shed. They should not need to go through another person's dwelling to access it and it should not be located in an area used in common with the occupants of another dwelling. In addition, the sink should not be located in a garage, even where this is adjoined to the dwelling.

T6. Has the dwelling a water closet available for the exclusive use of the occupants of the dwelling suitably located within the dwelling?

A dwelling meets the tolerable standard if it has a water or waterless closet available for the exclusive use of the occupants of the dwelling and suitably located within the dwelling. **If the dwelling does not have an inside WC, it is below tolerable standard.**

This element of the tolerable standard aims to ensure that every dwelling in Scotland has an inside toilet that is not shared with any other dwelling. It is important that the occupants of the dwelling can access the toilet safely and that there is a wash-hand basin close.

The tolerable standard has always included the requirement for there to be a water closet inside the dwelling. However, the definition was expanded in 2003 to include

“waterless closet”. The term was included in the Housing (Scotland) Act 2006 to confirm its place in parliamentary legislation.

The tolerable standard states that the water closet should be suitably located within the dwelling. Surveyors will need to think about the following factors when considering the location of the water closet:

- the position of the water closet within the dwelling (ie can it be accessed safely and conveniently);
- the amount of activity space around the water closet;
- the proximity of hand-washing facilities to the water closet.

The WC should be located in such a position within the dwelling that allows all occupants and visitors safe and convenient access to it. If the only WC is positioned mid-flight off stairs, requiring the user to step from and onto a split-level surface, the dwelling is below tolerable standard.

Also, if the WC is located immediately next to a kitchen area, is not separated by a doorway, or does not have a wash-hand basin suitably located, the dwelling is below tolerable standard.

In some cases, the only WC in the dwelling will be located off a bedroom and can only be accessed by walking through the bedroom. In dwellings with only one bedroom, this type of arrangement will be satisfactory. However, a dwelling with more than one bedroom must have at least one WC that occupants and visitors can access without going through a bedroom, otherwise it is below tolerable standard.

A WC should have sufficient room around it to allow a non disabled user of average size to use it comfortably. Surveyors will need to make a judgement on the size of the space in which the WC is located and he/she should consider the height of the ceiling, the space directly in front of it, and how easily users can access it. If the surveyor believes that the lack of space prevents the occupants from comfortably using the WC, the dwelling is below tolerable standard.

A surveyor should check that there is a wash-hand basin available close to the WC (go to section on bath, shower & wash-hand basin for guidance on how to assess the wash-hand basin). If the wash-hand basin is not located immediately next to the WC, then it should be in the space outside the enclosed space containing the WC, such as in the hallway. However, a kitchen sink, normally used in the preparation of food, is not a satisfactory wash-hand basin for this purpose. A dwelling that does not have a wash-hand basin located close to the WC is below tolerable standard.

It is important to note that while a water closet, which opens directly onto a kitchen may meet the criteria above that does not necessarily mean it will be tolerable in all circumstances. It must still be tested against other appropriate items in the Tolerable Standard. Thus, for example the water closet must have satisfactory provision for natural or artificial lighting and for ventilation and there must be an effective system for the disposal of foul water. Local authorities will also wish to satisfy themselves that the configuration of the rooms concerned does not prevent the kitchen from having satisfactory facilities for the cooking of food. If any one of these criteria is not met then the dwelling will continue to fail the Tolerable Standard, as it will do also if some other location is unsuitable. There are of course, now many dwellings with more than one

water closet; if at least one water closet in a dwelling meets the requirements of the Tolerable Standard the dwelling meets the standard in respect of the criteria relating to water closets.

T7. Has the dwelling a fixed bath/shower and a wash-hand basin all with a satisfactory supply of hot and cold water suitably located within the dwelling?

A dwelling meets the tolerable standard if it has a fixed bath or shower and wash-hand basin, each provided with a satisfactory supply of hot and cold water and suitably located within the dwelling.

This element was introduced in the Housing (Scotland) Act 2001. The Housing (Scotland) Act 2006 did not change the definition.

The purpose of this element of the tolerable standard is to ensure all homes in Scotland have private facilities for personal hygiene. This should be a bath or shower, in addition to a wash-hand basin. These must be located inside the dwelling and should be available for the sole use of the occupants. In most cases, these facilities will be located in a bath or shower room.

Surveyors should look to identify a functional bath or shower, and a wash-hand basin inside the main part of the dwelling for the exclusive use of the occupants that they can access without going outside. These facilities should be fixed firmly to the floor or wall and connected permanently to an appropriate drainage pipe.

Surveyors should note that the requirement for a dwelling to have a wash-hand basin is distinct from that for a sink.

The bath, shower or wash-hand basin should be fit for purpose and not broken or damaged to such a degree that it cannot be used and is beyond economic repair. For example, if a bath has a hole in it and cannot be filled with water, and the surveyors considers the cost of repairing the damage is dis-proportionate to the cost of replacement, the dwelling is below tolerable standard.

However, if the facility is in poor condition because it is unclean or damaged, but still usable, the dwelling is not below tolerable standard.

The bath, shower and wash-hand basin should have a fixed tap or taps capable of delivering a piped supply of both hot and cold water. The water may emerge from two separate taps or from a single mixer type tap. In the case of a shower, the water will normally emerge from a shower head and hot water will be supplied by an instantaneous boiler, or tank. In the case of electric showers, the shower device will normally heat the water instantly. The shower head may be fixed to the wall or ceiling, or may be connected to the water supply via a hose.

Check if there is a satisfactory supply of hot and cold water. In practice, this means surveyors may have to look for the presence of a water heating appliance. This will normally be a hot water storage cylinder supplied from a boiler, a combination boiler, or a smaller storage or instantaneous water heater located at the bath or wash-hand basin. The quantity of water the device should be capable of delivering is:

- for a wash-hand basin, a total supply of at least 7 litres of hot water in one continuous flow;
- for a bath or shower, the device must be capable of delivering 7 litres of hot water per minute, and in all cases enough to allow the occupants to fill a bath where a bath is the facility provided.

Surveyors should check that the appliance works and is capable of producing hot water. A house that does not have a water heating system capable of providing a suitable continuous supply of hot water at the shower, bath or wash-hand basin is below tolerable standard.

If the water heating device is broken or damaged, and surveyors believe it is not fit for purpose and be beyond economic repair, the house is below tolerable standard.

However, if a surveyor judges that the device can be repaired and thinks that this will be done soon after the visit, the house is not below tolerable standard.

T8. Has the dwelling an effective system for the drainage and disposal of foul and surface water?

A house meets the tolerable standard if it has an effective system for the drainage and disposal of foul and surface water.

The tolerable standard has always included the requirement for a house to have an effective system of drainage of surface and foul water. The Housing (Scotland) Act 2006 does not change this.

This element of the tolerable standard requires every house to have a drainage system capable of managing and disposing of wastewater and rainwater. This ensures that the house remains watertight and assists in providing the occupants with a safe, hygienic environment.

Wherever possible, look at the house's system for the drainage of surface water and consider if all the necessary parts are present. A typical drainage system will have gutters attached to the roof at the lowest ends of each slope. Each gutter will be fixed securely to the roof and fall towards a connecting down-pipe which will continue from the gutter to at least ground level, where it will transfer the water to an appropriate drain, soakaway, or free-draining soil.

Surveyors should look for evidence that the system may not be able to cope and use their experience to judge each case. The following indicators will help surveyors reach his/her decision:

- localised discoloured patches on the exterior walls of the house;
- penetrating damp affecting the interior of the house;
- feedback from occupiers that the system overflows during normal levels of rainfall.

Surveyors should be aware that while the presence of one of these indicators may indicate that the house could be below tolerable standard, this will not always be the case. The problem may be the result of a blockage which could be cleared easily, such

as weeds or leaves. In these situations the house would not be below tolerable standard.

The surface water drainage system will normally transfer rainwater from rooftops and other surfaces to a nearby storm drain. Storm drains carry rainwater to local rivers and streams where it enters the watercourse untreated. Some houses will have combined surface and foul water systems, and in such cases the surface water is disposed of in the same way as the foul water. Houses in some rural areas do not have access to storm drains, so other arrangements will be used instead, such as a soakaway. Disposal of surface water to land adjacent to the house in this way will not normally cause a house to be below tolerable standard, provided there is no ponding and the water drains away effectively. If, however, the soakaway is not effective, the house may be below tolerable standard.

For foul water drainage, surveyors should, where possible, look at all elements of the foul water drainage system inside and outside the house to identify any defects. This means looking at any exposed pipes connecting to:

- toilets;
- sinks;
- wash-hand basins;
- baths and showers.

For both foul and surface water drainage, surveyors should look for any defects and/or inadequacies in the system that mean it is, as a whole, not effective. Minor defects, such as a loose or blocked gutter, or a crack in a down-pipe, will not normally mean the house is below tolerable standard. The system should be fit for purpose and no gutters or pipe-work should be broken, or damaged to such a degree that the system as a whole is not effective and beyond economic repair.

Symptoms of ineffective or failed systems could include seepage, discolouration of the ground, or smells. Surveyors do not have time to investigate the source of these symptoms, especially if near trees or large shrubs whose roots may have caused damage to the system. Such symptoms are not conclusive evidence of an ineffective system; they may instead indicate the need for a repair to an otherwise suitable system.

Most houses will dispose of foul water to a public sewerage system. But, again, for some houses this is not possible. Alternative methods for disposing of foul water include septic tanks and private outfalls. Where the foul water is transferred to a septic tank, a surveyor should check wherever possible that all pipe-work and connections are sound and not damaged. The septic tank should be properly maintained and there should be no evidence that the tank is leaking, such as ponding of foul water near the tank.

Occasionally, surveyors may find that a house disposes of its foul water to a mass collection tank (sometimes referred to as cess-pits or cess-pools) located in the garden or neighbouring land. These differ from septic tanks in that the foul water lies untreated in the tank until it is emptied. A house that uses this type of system is below tolerable standard

Private outfalls dispose of foul water to a nearby watercourse, such as a loch, river or stream. Some houses use sea out-falls, and surveyors should check that the pipe disposes of the wastewater below the low-water mark.

T9. Has the dwelling satisfactory facilities for the cooking of food within the dwelling?
--

A house meets the tolerable standard if there are satisfactory facilities for the cooking of food within the house.

The tolerable standard has always included the requirement for there to be satisfactory facilities for the cooking of food inside a house. The Housing (Scotland) Act 2006 has not changed this.

Surveyors should consider this element in terms of the minimum facilities needed to allow an occupier to cook food safely within the house. Surveyors should not judge a house on the presence or otherwise of cooking appliances, but on the ability of the house to support such activity safely.

A cooking appliance must be able to be installed inside the main living area of the house. This means that an occupier should not have to go outside, or through someone else's property, to reach the cooking facilities.

Surveyors should look for a fixed power source that an occupant could use to operate a cooking appliance in the house. This can be:

- a fixed electrical power point suitable for a standard electrical cooker;
- a mains or Liquefied Petroleum Gas (LPG) gas point, capable of being connected to the supply and switched on;
- an oil supply.

If the power source is oil or solid fuel, the cooker must be present, permanently connected to a flue, and there must be suitable and safe storage for the fuel. Where this is not the case, the house is below tolerable standard.

Where there is no fixed power source available, the house will be below tolerable standard.

Surveyors should wherever possible ensure that a cooker, if present in the house, is connected to an appropriate power source. If the cooker is powered by electricity, it must be connected to a fixed electrical power outlet suitable for a standard electrical cooker (30/45 amp power outlet). Surveyors should refer to the section of this manual covering electrical installations.

In most cases, a house will have a kitchen in which there will be a cooking appliance installed. The issue, however, is whether the house has an appropriate space to locate a cooking appliance.

A cooker should not be located under a stair, in a cupboard off a room, in a garage, or anywhere that requires the occupier to go outside or through another person's house to access it. A house where the power source for a cooker is located in any of these places will normally be below tolerable standard. A cooker should normally be

positioned in the house close to a sink with hot and cold water. This is necessary because a sink should be available to allow the occupants to prepare food hygienically.

Surveyors should consider the suitability of the location of a space for a cooking appliance primarily in terms of safety. The room should be large enough to allow the user to work safely at a cooker, including the handling of hot food. The floor in front of it should be clear so that the oven door can open fully. The location should be properly ventilated and surveyors should refer to the section on ventilation.

This does not mean that a cooker must be provided. The item is concerned with the availability of a suitably located space, ie. well-ventilated and well-related to the pattern of movement within the dwelling, at which normally a power supply is provided. In remote areas calor gas might suffice.

T10. Is there satisfactory access to all external doors and outbuildings?

This requirement is likely to be relevant in relation to dwellings in the attics of tenement dwellings and certain dwellings produced by conversion.

A house meets the tolerable standard if it has satisfactory access to all external doors and outbuildings.

This element of the tolerable standard ensures that occupants and visitors are able to move safely between the edge of the property, the external doors to the main habitable part of the house, and all outbuildings.

The recommendations in this guidance are based on what a non disabled person of average build would be capable of achieving and specifically does not consider access from the perspective of people with restricted mobility.

This guidance will help surveyors to decide if a house meets the tolerable standard. In particular, it will focus on factors that may mean the safety of those using the access routes around the house is compromised.

The guidance provided in Part 12 advice on how to judge if the access route is satisfactory. But the basic test assessors should consider is whether an occupant or visitor can move safely between the area immediately in-front of and around the house, all main door(s) to the house, and any outbuildings in use. A house may have multiple access routes and all must be satisfactory for the house to meet the tolerable standard.

External doors refers to all main doors providing access directly into the main living part of the house, and will often be a standard front and back door. The access route starts from immediately outside the house and extends to immediately outside the main doors giving access to the main living part of the house. For some houses the access route will be via a passageway or stair.

Outbuildings includes any in-use building or structure associated with the house that can only be accessed by leaving the main living part of the house. Examples of outbuildings include:

- garages;
- bin stores;

- wash-houses;
- drying-rooms/areas;
- solid fuel storage areas;
- outside toilet;
- cellars.

Surveyors should consider the following:

- are all doorways and passageways to the house unobstructed and of sufficient size?;
- are all paths and stairs safe underfoot?;
- are all railings safe?;
- is there satisfactory provision of artificial lighting for all access routes?

For more detailed information refer to 15.13 to 15.25 in Part 11 of this manual.

T11. Are electrical systems within the dwelling safe?

A house meets the tolerable standard if, in the case of a house having a supply of electricity, it complies with the relevant requirements in relation to the electrical installation for the purposes of that supply.

The tolerable standard is amended by the Housing (Scotland) Act 2006 and now includes this new element covering electrical installations. For the first time assessors will look at the nature and condition of an electrical installation in a house when deciding if the house meets the tolerable standard. This element of the standard only applies to houses that have electrical installations connected, or capable of being connected, to a supply of electricity.

The tolerable standard was first defined in the Housing (Scotland) Act 1969. The Housing (Scotland) Act 2006 introduced this new element. The introduction of electrical installations in the tolerable standard is primarily in recognition of the danger unsafe wiring poses to the occupants of a house.

Surveyors should use their answers to questions L6 and L7 to formulate a judgement here.

For more detailed information refer to 15.13 to 15.25 in Part 12 of this manual.

T12. Is the dwelling satisfactorily insulated?

A house meets the tolerable standard if it has satisfactory thermal insulation.

To comply with the tolerable standard a house must have satisfactory thermal insulation. This new requirement reflects a recommendation from the Housing Improvement Task Force. The Task Force noted the existence of a consensus that some basic thermal insulation is essential to the functioning of a building as a home. It also highlighted a major change in expectations in respect of the thermal performance of a house over the past thirty years.

The 2006 Act added this new element to the tolerable standard.

The concept of thermal insulation relates to the capacity of a house to retain heat. It can refer to both the performance of building elements and the impact of any insulation measures added after construction.

So, thermal insulation relates *only* to the capacity of the house to retain heat. It does not extend to the performance of the heating system or the interaction between the heating and the building fabric.

Surveyors should use the presence of roof insulation in a house as the indicator of satisfactory thermal insulation.

The information to form this assessment is collected in M26, Q33 and Q42.

The presence of roof/loft insulation in any of these locations means the dwelling PASSES the tolerable standard.

Mid floor flats with non-heat loss roofs should be counted as having roof insulation for the purpose of the survey and should be regarded as a PASS.

If any roof insulations are UNOBTAINABLE then surveyors and some are missing the surveyors should record this section of the tolerable standard as UNOBTAINABLE.

T13. Would you expect action to be taken on this dwelling under the housing acts?

The simple guide as to whether action required should be undertaken under a Repairs Notice or under an Improvement Order is that:

If an element exists, but is in serious disrepair, then a repairs notice should be served e.g. DPC, roof covering etc. exists but is in disrepair.

If however, an element or amenity does not exist and is therefore being provided for the first time an improvement order would be served. e.g. no DPC, WC or bath.

The main exception to this rule is in the case of structural instability. Where a dwelling is unstable and the instability is due to foundation problems then either an Improvement Order or Repairs Notice could be served. As a general rule the greater the area of instability the more likely it is that an Improvement Order should be served.

Alternatively if the instability is affecting, for example, part of the wall(s) of a dwelling and this was due to defective gutters causing water erosion of pointing then a Repairs Notice would be served.

Code 1: NO ACTION

The dwelling is not below the tolerable standard (BTS).

Code 2: REPAIRS NOTICE:

The service of a Repairs Notice would generally be considered where one or both of the following criteria are met:

- the living conditions of the occupants are affected;
- the fabric of the dwelling or an adjoining dwelling is threatened.

NOTE: **The dwelling need not be BTS.**

The building defect causing the disrepair might be a major item, for example, a nail sick slate roof or a minor item, for example, defective lead flashings or gutters.

Examples of disrepair that would result in the service of a Repairs Notice include:

- dry or wet rot of a serious nature;
- displaced or corroded structural supports;
- loss of tie between walls;
- penetrating dampness of any sort (unless minor);
- disrepair to drainage services (collapsed sewers, blockages etc.).

NOTE: The information recorded elsewhere on the physical survey form provides indicators as to whether a Repairs Notice is appropriate.
You should refer to your answers to H10, R1-8, R10, R16 and R18.

Code 3: IMPROVEMENT ORDER

The service of an Improvement Order would generally be considered where facilities are being provided for the first time to bring dwellings up to the Tolerable Standard. This might take the form of the installation of a fixed bath or shower, a hot water system, a DPC, a satisfactory drainage or water supply system that did not previously exist.

An Improvement Order should be considered for individual dwellings or dwellings situated in blocks or tenements where surrounding dwellings are modernised and well maintained.

The dwelling must be BTS.

NOTE: The information recorded elsewhere on the physical survey form provides indicators as to whether an Improvement Order is appropriate.
You should refer to H2, H6, H8-9, K1, K3, K7 and K11-14.

Code 2/3: REPAIRS NOTICE OR IMPROVEMENT ORDER

NOTE: The information recorded elsewhere on the physical survey form should help you to determine whether a Repairs Notice or an Improvement Order is appropriate.
You should refer to your answers to H3, H4, H10, I1-3, R9 and R11-13.

Code 4: CLOSE OR DEMOLISH

Closing Orders, prohibiting the use of the dwelling for human habitation, are issued by local authorities against dwellings that do not meet the Tolerable Standard and that should be demolished when:

- (a) the dwelling forms part of a building, and
- (b) the building does not comprise only dwellings which do not meet the Tolerable Standard.

Demolition Orders can be served by local authorities against any building that only comprises a dwelling(s) which does not meet the Tolerable Standard and that should be demolished. Demolition Orders are used where it appears to the local authority that the building is dangerous to persons inhabiting or frequenting it or adjacent buildings or places or to the public generally.

NOTE: Only use this code if the main structure of the building cannot be improved, for example, corrugated iron structure. If it is a solid structure then it should be assessed for improvement or repair.

Code 9: UNOBTAINABLE

You are unable to reach a view as to whether or not action would be taken on this dwelling under the Housing Acts.

T14. Would you expect the common parts to be subject to a repairs notice?

NOTE: Repairs Notices to 4-in-a-block type to be included here.

The assessment for Repairs Notices to the common parts is very similar to that for dwellings. Any disrepair considered to require a Repairs Notice must be serious.

You should refer to your answers to P1-6, R1-7, R9-11, R13.

Code 1: NO ACTION

Code 2: ACTION

Action in the form of a Repairs Notice, applies to both private and public tenures.

Refer to Part 3 for Repairs Notice under Section 108 of the Housing (Scotland) Act 1987.

Code 8: NO COMMON PARTS

The dwelling is a house and has no common parts.

Code 9: UNOBTAINABLE

You are unable to reach a view as to whether or not the common parts would be subject to a Repairs Notice.

T15. Write in reason for each BTS failure at T1 to T12

If you have coded the dwelling as BTS (code 2) for any of the questions T1 – T12, then you must write an explanation detailing your reasons for **every** failure of the tolerable standard alongside the question number to which the reason relates.

Please use capital letters so that your notes are easy to read.

NOTE: Do not use the surveyors' notes box for recording information related to any failure of the tolerable standard.

Section 3 Definitions

To promote consistent standards of measurement, surveyors must conduct their inspection according to a set of shared definitions. These are described in this section. Survey definitions are not negotiable and must be strictly adhered to in every circumstance.

3.1 Definition of a dwelling

For the purposes of this survey, the term 'dwelling' has been used throughout. It refers to a self-contained unit of accommodation. 'Dwelling' also substitutes for 'house' where this term occurs, eg in extracts from legislation and circulars.

Generally, for accommodation to count as a dwelling it must be structurally separate behind its own front door, with the occupant(s) able to get in and out without passing through anyone else's living quarters.

This definition will cover the majority of situations that surveyors will encounter. Dwellings will normally be included within one of the following categories:

1. The normal house or bungalow, which has not been altered in any way for separate occupation by more than one household;
2. A flat* or maisonette in a purpose built tenement block;
3. A self contained flat or apartment in a converted house, villa or a previous non-residential use;
4. A one apartment flat (studio type) with purpose designed sleeping recess, proper food preparation facilities, and internal bathroom and WC;
5. A self-contained dwelling, which is the only living accommodation in premises otherwise used for non-residential purposes.
6. Flats in purpose-built pre-1919 tenement blocks with shared facilities in the close are to be regarded as single dwellings for the purposes of this survey. These shared facilities are recorded at Questions K1 and K2.

NOTE: Should you find a non self-contained unit of accommodation, as may be the case in converted blocks, you should refer the circumstances to your monitor.

3.2 Definition of a habitable room

Rooms are the basic survey unit for the dwelling interior.

For the purposes of assessing condition, it is necessary to identify all rooms in the dwelling. However, for the purpose of classifying dwellings according to their size, only habitable rooms are counted. Habitable rooms must be of a minimum of 4.65m².

Habitable rooms provide the living accommodation of the dwelling. These include:

- living rooms;
- dining rooms;
- bedrooms;
- playrooms or study;
- kitchens (whether or not in present use);
- sculleries, if used for cooking;
- dual purpose rooms such as a '1 apartment' or large living rooms which may contain an open staircase.

The room should also have some provision for any sort of ventilation and natural lighting (no matter how inadequate).

NOTE: Rooms divided by curtains or portable screens count as one room.
Rooms divided by double doors or a fixed/sliding partition count as two rooms.
Similarly, if an extension has been built onto an existing room then the space created is a single room.

Rooms not to include:

- bathrooms, toilets and closets;
- stairs, halls, landings or other circulation spaces;
- utility rooms and store rooms;
- attic or basement spaces which are basically storerooms but may have been used occasionally as habitable accommodation;
- conservatories (whether heated or not).

NOTE: Rooms or so-called in outbuildings which are attached to the dwelling but are only accessed from the outside are not rooms for the purposes of this survey. To be classed as 'outside', access to the outbuilding must be via a non-enclosed space or a covered passage open on at least one side or end.

3.3 Definition of a porch

Porches are not rooms as defined by the SHS and are **not** included in the room count at question J1.

Porches are not included as part of the dwelling measurements (Section N) **unless** they form part of a room.

A porch:

- Must be attached to and project from the dwelling
- Must be single storey
- Must provide enclosed weather protection to any principal entrance
- Must have a full separating door between the porch and the dwelling
- Can be built at the time of the dwelling or subsequently
- Cannot contain a room or a W.C.
- Where more than three-quarters of the area of the roof and more than one-half of the area of its external walls is made of translucent material:
 - floor area **8m² or less**: classed as **porch**
 - floor area **greater than 8m²**: classed as a **conservatory**.

3.4 Definition of a conservatory

Conservatories are not **rooms** as defined by the SHS and are **not** included in the room count at question J1

Conservatories are not included as part of the dwelling measurements (Section N) **unless** they form part of a room.

A conservatory:

- Must have more than three-quarters of the area of its roof and more than one-half of the area of its external walls made of any clear or translucent material.
- Must be attached to the dwelling.
- Must provide enclosed weather protection
- Must be accessible from the interior of the dwelling
- Will normally have a full separating door between the dwelling and the conservatory
- Can be built at the time of the dwelling or subsequently
- Where the construction being surveyed complies with the above, the following rule applies.
 - floor area **8m² or less**: classed as **porch**

- floor area **greater than 8m²**: classed as a **conservatory**.

3.5 Underground rooms and basements

For the purposes of this survey a basement is a storey which has its lowest floor level at least one metre below the street or general ground level.

Where a dwelling is on a sloping site and below ground level on one side and at a lesser level elsewhere the one metre rule is to be an average applied at the centre of the dwelling.

Where a dwelling is protected by retaining walls the surface of a floor is to be regarded as a basement level if it is more than one metre below any ground or street and the retaining walls are within three metres of the floor. This restriction to a retaining wall(s) does not apply if a daylight angle of 45 degrees to that floor level can be achieved.

3.6 Definition of a common block

A common block may be defined as a group of dwellings with a shared access to two or more dwellings under the same roof and where the cost of repairs to common parts may be apportioned on a dwelling basis. This should include mixed uses under the same roof such as shops or offices where a similar proportion of costs applies.

For the purposes of this survey, when surveyors are considering blocks of flats or linked flat blocks which are built as semi-detached or terraced units they must determine the common block (which must include the selected dwelling) on the basis of the smallest repetitive unit served by one common stair or close.

The same criteria is to be used to select the smallest repetitive unit where '4 in a block types' are halved and from ends to blocks. Use the stair/own door and roof approach as a common denominator.

NOTE: The group selected is the basis for all questions on the common block in Sections E,O, and N.

3.7 Definition of common access

For the purposes of this survey, a structure with common access is a building where two or more flats or maisonettes share either a common entrance with or without stair access, or an external staircase whether or not there is (are) an own door flat(s) entered separately elsewhere in the same block. The sharing of footpaths and external steps at ground level is excluded from this assessment.

NOTE: Access type relates to the block in which the dwelling is located, not to the selected dwelling itself.

3.8 Definition of an area

In this case “area” refers to the broader geographical area surrounding the dwelling – not just the immediate houses or streets surrounding it – and consideration should be given to issues such as housing density, population, presence of major services and commercial centres and availability of transport links. Generally a reliable impression of the area can be gained during the initial search for the dwelling. Boundaries to the area are likely to be roads, railways lines, canals etc. In some cases establishing a clear boundary may be more problematic: in this case surveyors should look for changes in land use, housing style or other indicators of difference.

To put an imaginary boundary on this area the surveyor will need to be aware of the character of the surrounding streets. Generally the surveyor will be able to form a reasonable impression of this when looking for the address initially.

Look for natural features which may help in the drawing of boundaries e.g. marked changes in land-use, changes in housing density, changes in housing type/age, road or rail divisions.

Section 4 Housing Standards

A number of common standards relating to condition assessment have been defined for the purposes of the survey. Some of these, such as the Tolerable Standard, are drawn from housing legislation whilst others have been adopted to ensure comparability with other housing data in Scotland e.g. Local House Condition Surveys. Surveyors are required to apply these standards rigorously and consistently when working on the SHS.

4.1 The tolerable standard

A house meets the tolerable standard if it:

- is structurally stable;
- is substantially free from rising or penetrating damp;
- has satisfactory provision for natural and artificial lighting, for ventilation and for heating;
- has satisfactory thermal insulation;
- has an adequate piped supply of wholesome water available within the house;
- has a sink provided with a satisfactory supply of both hot and cold water within the house;
- has a water closet or waterless closet available for the exclusive use of the occupants of the house and suitably located within the house;
- has a fixed bath or shower and a wash-hand basin, each provided with a satisfactory supply of both hot and cold water and suitably located within the house;
- has an effective system for the drainage and disposal of foul and surface water;
- in the case of a house having a supply of electricity that the electrical installation is adequate and safe to use;
- has satisfactory facilities for the cooking of food within the house;
- has satisfactory access to all external doors and outbuildings.

Most of these criteria have been part of the tolerable standard since its introduction in the 1969 Act. The 2001 Act added the bath / shower and wash-hand basin element. Waterless closets were added by administrative order in 2003. The 2006 Act introduces the most significant change to the criteria – the addition of thermal insulation and electrical installations, and also confirms the addition of waterless closets.

NOTE: Failure to meet any one of these requirements will result in the dwelling being classified as Below Tolerable Standard (BTS). Care should therefore be taken to ensure that a dwelling classified as BTS genuinely merits this classification. Your attention is drawn to the specific guidance for each question.

4.2 Guidance notes for the tolerable standard

For full Guidance Notes on The Tolerable Standard refer to Part 11 of this manual.

4.3 Repairs

Assessment of repair is based on the assumption that dwellings will be put in a reasonable state of repair and that given reasonable standards of maintenance, dwelling will achieve thereafter a useful life of 30 years.

In assessing repairs surveyors **must exercise their professional judgement** and take no account of actions that might be uneconomic.

The general assumption to be made is **no fault seen means no repair**.

It must not be assumed that elements which cannot be repaired to a standard to meet the 30 year life span should automatically be replaced. Often there will be aged elements which may have an estimated 10 year remaining life which require minor or no repair. In these cases a low or nil repair score should be recorded and an appropriate shorter life span, say 10 years, entered in the replacement period column. On the other hand there will be other elements that will have an even shorter life not worthy of repair. In these cases full repair or renewal should be recorded together with the full expected life for that new part.

The repair assessment should include all works to make the dwelling 'tolerable for habitation' (ie. above the Tolerable Standard) as well as to any sub-standard rooms included in the room count.

4.4 The replacement period

The replacement period is the residual life of the whole element in years (approximated - see text), whether repaired or not. The residual life assumes that some normal maintenance will be carried out and that for most of the dwellings the elements will be found to be at various stages in their life cycle. The maximum estimate for this survey is to be 30 years even though some of the major structural elements may well exceed this.

4.5 Urgency of repair

Surveyors are required to determine whether repairs recorded to be done urgently. Where no disrepair is recorded then an surveyors will need to assess whether normal or urgent maintenance is required. This is a change from the previous surveys where urgency was classified as not applicable for no disrepair. This change is to address the requirements of Historic Scotland with regard to building maintenance.

Urgent repairs are: those elements associated with keeping the building envelope in a wind and weather tight condition. If left

unattended, these repairs will result in a further deterioration in the fabric of the block/dwelling; or

those associated with the health, safety or wellbeing of the occupants of the block/dwelling.

Non urgent repairs are: those elements in disrepair which are not considered to be urgent

Urgent Maintenance: elements not in disrepair (score 00) but requiring to be maintained urgently.

Normal maintenance: the norm for elements not in disrepair

Not Applicable: those elements which do not exist.

Section 5 Potential action

5.1 Repair notice

Where houses are in a state of serious disrepair, local authorities have the power to serve repair notices under the Housing (Scotland) Act 1987. This is defined in Section 108 of the Act as follows:

- Section 108 (1) Where a local authority are satisfied that any house in their district is in a state of serious disrepair, they may serve upon the person having control of the house a repair notice.
- (2) A repair notice shall -
- (a) require that the person to execute the works necessary to rectify such defects as are specified in the notice within such reasonable time, being not less than 21 days, as may be specified in the notice, and
- (b) state that, in the opinion of the authority, the rectification of those defects will bring the house up to such a standard of repair as is reasonable having regard to the age, character and location, and disregarding the internal decorative repair, of the house.
- Section 108 (7) Where a local authority are of the opinion that a house in their district is in need of repair although not in a state of serious disrepair and that it is likely to deteriorate rapidly, or to cause material damage to another house, if nothing is done to repair it, they may treat it as being in a state of serious disrepair for the purposes of this Part.

5.2 Improvement order

This is for use in connection with the improvement of houses below the tolerable standard outside housing action areas as defined in Section 3.3.3. The improvement order is defined in Section 88 of the Housing (Scotland) Act 1987, as follows:

- Section 88 (1) ...where a local authority are satisfied that a house which is not situated in a housing action area does not meet the tolerable standard, they may by order require the owner of the house within a period of 180 days of the making of the order to improve the house by executing works -
- (a) to bring it up to the tolerable standard; and
 - (b) to put it into a good state of repair;
- and where the local authority are satisfied that the house has a future life of not less than 10 years, they may in addition require the execution of such further works of improvement as to ensure that the house will be provided with all the standard amenities within that period.'
- Section 88 (2) In subsection (1), reference to house which does not meet the tolerable standard includes a reference to a house which does not have a fixed bath or shower and reference to executing works to bring it up to the tolerable standard includes reference to installing a fixed bath or shower.
- (Subsection (2) empowers local authorities to make improvement orders solely for the installation of a bath or shower).'

5.3 Closing/demolition orders

The power of local authorities to make closing and demolition orders is defined at Sections 114 and 115 of the Housing (Scotland) Act 1987, as follows:

Section 114 (1) Where a local authority, on consideration of an official representation or a report by the proper officer or other information in their possession, are satisfied that any house does not meet the tolerable standard and that it ought to be demolished and -

- (a) the house forms only part of a building, and
- (b) the building does not comprise only houses which do not meet the tolerable standard,

the local authority may make a closing order prohibiting the use of the house for human habitation.'

Section 115 Where a local authority, on consideration of an official representation or a report by the proper officer or other information in their possession, are satisfied that any building comprises only a house which does not meet, or houses which do not meet, the tolerable standard and that the house or, as the case may be, houses, ought to be demolished, they may, subject to section 119, make a demolition order requiring -

- (a) that the building shall be vacated within such period as may be specified in the order, not being less than 28 days from the date on which the order comes into operation, and
- (b) that the building shall be demolished within 6 weeks after the expiration of that period or, if the building is not vacated before the expiration of the period, within 6 weeks after the date on which it is vacated.'

Demolition orders in respect of dangerous buildings are defined in Section 13 of the Building (Scotland) Act 1959, and should be used:

Section 13 If it appears to the local authority that any building is dangerous to persons inhabiting or frequenting it or adjacent buildings or places or to the public generally.'

Section 6 Surveyor Administration

6.1 Introduction

The fieldwork manual provides information on how to carry out your fieldwork effectively. It provides details of the surveyor addresses, the operation of the CADS web-based appointment system, what to survey, the use of photographs, the paperwork you will be required to complete, use of the CADS website and how your progress will be monitored. It also contains information on how to deal with any problems you may encounter while undertaking the surveys, and how claims for payment should be made. Please read this section carefully.

SUMMARY OF REQUIRED WORK

During the year you will be issued with up to 90 survey appointments and will be expected to carry out the surveys in accordance with the procedures laid down here. It is very important that your allocations are carried out on time. The appointment system is to assist you in achieving full surveys without repeat visits to properties, but it will only work if you stick strictly to the system laid down and the overall timescales for the work.

In some cases, surveyors may be asked to survey more than 90 addresses in a year. However, you should note that, for statistical reasons, surveyors are limited to carrying out a maximum number of Full surveys in each survey year. The majority of addresses will already have been included in the SHS interview survey and will come to you via the appointment system on the CADS Website.

However, for some addresses social interviewers will not have conducted an interview or been able to make an appointment. Every attempt must be made to undertake a full internal and external survey at all addresses issued for a Full Survey. We need you to be able to work flexibly, including evenings and weekends to complete your allocations.

At all addresses that were included in the SHS social survey, it is important that you visit the correct address, and make sure that it is the same address that was visited by the Ipsos MORI interviewer. No substitutions of other properties may be made. Any discrepancies in address information that you come across during the course of your survey work must be passed to the CADS Helpline immediately. If you do not think the interviewer has defined the dwelling correctly, you should redefine the dwelling using the definitions in the main manual and then refer on to your Regional Manager. You should amend the address on the Website.

Photographs should be taken at all addresses (with the very specific exceptions laid down in the Manual). You must not take any photographs inside the property and no more than 4 photographs should be taken of each property.

As a quality control measure, Regional Managers will accompany surveyors in the field for a proportion of their surveys. They will also be able to assess surveyors' progress and capabilities and offer help if the surveyors are having difficulties with one or more parts of the form.

It should be pointed out that although continuous development has been carried out on the survey form, it cannot accommodate some of the more unusual situations that you may come across. If you feel that the answers coded on the form do not represent a proper picture or could be misunderstood, please write notes or draw diagrams on the back page of the form, as these will be invaluable when we are checking for errors or apparent inconsistencies in the data.

SUMMARY OF THE TYPES OF SURVEY REQUIRED

The physical surveys will take place after an Ipsos MORI interviewer has attempted to carry out a social interview. The type of physical inspection survey required is dependent on the outcome of the interviewer visit.

For addresses where a successful social interview is carried out, and the respondent is willing to have physical inspection, addresses will be allocated to surveyors for a full physical inspection. For these addresses a firm appointment time will have been made with the householder.

In the event of any appointment being broken, you will be required to make at least three further attempts to gain a full survey on different days. These calls should be made at different times of the day, with at least one in the evening and one during the weekend. For dwellings where no contact is made on the fourth call, a Dwelling Description Survey should be carried out. (External only surveys were discontinued at the end of 2009). All dwellings where the occupant refuses permission to undertake a Full Survey, an Abbreviated Dwelling Description should be carried out.

The other outcomes to the social interview can be grouped into four categories:

1. Addresses where no physical inspection is required – these will not be allocated to surveyors and include the following outcomes: property demolished; non-residential property; or institutional property.
2. Addresses where an abbreviated dwelling description is required. These addresses are where the householder refused to be interviewed. No photos should be taken, and only summary information is required, namely page 1 of the survey form only.
3. Addresses where a dwelling description only is required. These addresses will primarily be second homes or holiday homes. These properties fall outside the scope of the social survey and thus, do not require a full physical survey.
4. Addresses where a dwelling description is required, but if possible, a full survey should be completed. These addresses will tend to be where interviews failed to make contact with the householder. At these addresses, if the householder is present, you should attempt to complete a full inspection. Otherwise you should complete a dwelling description. No repeat visits are required to these addresses.

The type of physical inspection required, along with the outcome to the social interview, will be detailed in your work allocations.

6.2 Planning workloads and availability

Surveyors must plan their availability to be able to maintain regular progress during the survey fieldwork. This availability will vary between surveyors and we appreciate that many of you are undertaking SHS physical survey on a part-time basis. However, you

should approach your availability in a common-sense way and include a mix of weekday, evening and weekend working in your diary. You need to keep pace with the Interviewers, who will be working on the addresses about a week ahead of Surveyors.

This aspect of your performance is crucial to the success of the survey and will be closely monitored.

You will enter your availability on the website to enable the CADS Helpline to allocate appointments accordingly. Interviewers have been asked to group the appointments, as far as possible, in a sensible, logical and economical way and will take account of travelling time between appointments, but not the initial journey to the first appointment.

It could help you considerably if you discuss your normal pattern of availability with the CADS Helpline and discuss the roles you each have.

SURVEY ADDRESSES AND QUOTAS

For statistical reasons, we are required to ensure that individual surveyors do not undertake a disproportionate number of surveys within each Unitary Authority. Surveyors will therefore be required to work in more than one Unitary Authority each year and you can expect to be allocated addresses out of your own Unitary Authority. Over a three year period, you will be required to work in at least three Unitary Authority areas.

ADDRESSES TO NAMED SURVEYOR

All survey addresses must be completed by the named surveyor to whom they are issued, except where, for reason of non-availability of the original surveyor, they are re-allocated to another surveyor. Surveyors are not permitted to pass survey addresses on to any other SHS surveyor, or any other individual, for completion. If you are unable to complete any addresses allocated to you, then contact the CADS Helpline.

CONVERTING DWELLING DESCRIPTIONS TO FULL SURVEYS

A proportion of the sampled addresses, where a social interview was not completed, will be allocated to surveyors to conduct a Dwelling Description Inspection. Dwelling Description addresses will be allocated to surveyors without an appointment time and without details of the occupants. These surveys require a brief visual inspection of the external elements of the dwelling, and do not require any inspection of the internal elements of the property.

The occupiers may be present in some properties that have been recorded as vacant, or where the social interviewer failed to make contact. In these circumstances, you should approach the occupier and ask for consent to conduct a Full Survey (if the property is used as a main residence). The following section on fieldwork procedures provides some tips about how to approach householders for a full survey.

You should advise the household that an Ipsos MORI interviewer will be in touch to conduct an interview. It would be helpful if you could obtain the householder's telephone number and pass this on to the CADS Helpline.

If the occupier refuses consent for a Full Survey, you will still be required to undertake an Abbreviated Dwelling Description.

6.3 Field work basics

The following section sets out the basic elements you will need to know in order to carry out the surveys effectively.

SURVEYOR IDENTIFICATION NUMBER

You have been allocated a unique two-digit identity number. This ID number should be used throughout the survey. It should be written on all paperwork and all survey forms.

UNIQUE ADDRESS NUMBERS

Each survey address has a unique 8-character serial number. The first digit identifies the year. The next two digits indicate the Unitary Authority. The next 4 digits represent the address number. The final digit is a check digit to enable us to make sure that all unique address numbers have been correctly entered.

The address number should always be used to identify any address in any correspondence with Ipsos MORI, CADS Helpline or your Regional Manager.

SURVEY ADDRESS LISTS

To satisfy the confidentiality protocols it is vital that you keep completed forms physically separate from contact details (e.g. as printed out from the “View Diary” page of the CADS website).

In the same vein, you must not write any addresses or other identifying marks on the survey form. If you need to note change of address details you should do this on the contact sheet (as printed out from the “View Diary” page of the website).

This is a very important safeguard of the confidentiality we have promised respondents to the survey.

SURVEY ADDRESSES

The interviewers have been briefed to identify dwellings and where the address is more than one dwelling to select one for interview. The address that has been allocated to you via the “View Diary” page of the CADS website is the address of the dwelling as identified by the interviewer, i.e. the address where they have conducted an interview.

You need to check that dwellings have been identified correctly (see main manual, section 3.0). What is defined as the dwelling is absolutely critical here, and surveyors should consult carefully the relevant sections in the main manual, which gives a lot of detailed information.

Important - if you consider the address you are given comprises more than one dwelling, it is then essential that you establish with which household the interview has been conducted. You should survey the dwelling that this household occupies. This will ensure that the interview and physical survey data are consistent.

If you are uncertain about what to survey, please contact the CADS Helpline and discuss your concerns before proceeding any further.

SELECTING A DWELLING

Most of the properties that you visit will be by appointment, arranged by your Ipsos MORI interviewer. The address on the diary page will show the dwelling address of the

property that is to be surveyed. You will also be provided with a contact name (i.e. the person who was interviewed and agreed to an appointment for a physical inspection of the property).

Very occasionally, you may find that the address that has been referred to you comprises more than one dwelling. If an interview was achieved, make sure that you make contact with the household that was interviewed and carry out a survey at their dwelling.

Where an interview wasn't achieved, multiple dwellings could arise because the interviewer has incorrectly assessed the original sample address as a single dwelling (e.g. a house that had been converted into 2 flats, each with their own exclusive amenities). It may also occur with properties where the interviewer has not made contact with a respondent, or was unable to gain sufficient information to establish that there was more than one dwelling.

If the address has not had a social interview carried out, and contains more than one dwelling, you may need to select a dwelling. This is very rare. In these instances, please call the Ipsos MORI SHS number for guidance on how to select a dwelling.

PROGRESS

Progress of each surveyor will be monitored by Ipsos MORI. If you are unable to make an appointment, you must contact the CADS Helpline as quickly as possible so contingent arrangements can be made.

NEW TECHNICAL INSTRUCTIONS

From time to time during surveyors fieldwork Ipsos MORI will dispatch any new briefings on technical issues that have been made by the Scottish Government. These will be decisions that have been made as a result of questions or queries that arise during other briefing sessions or while surveyors are in the field. Surveyors must ensure they fully understand and apply them. Any queries should be discussed with your Regional Manager. New decisions will be issued by e-mail and will follow the same format and numbering system as your main Manual. You should therefore print them off and insert them in the appropriate place of the Manual and treat them as permanent amendments.

6.4 Contact with households and gaining access

All addresses in the sample will have received an introductory letter from Ipsos MORI. Addresses where an interview has been successfully completed and an appointment made will also have received the SHS explanatory leaflet. In these situations your visit will be expected and we anticipate that access should be relatively easy.

However, there may be times when you encounter resistance on the doorstep from occupiers who have changed their minds following the interview survey. In these cases we would ask you to use persuasion to achieve the planned survey and a few do's-and-don'ts are given for your guidance, below.

PREPARATION FOR CONTACT WITH THE HOUSEHOLD

As mentioned above, it is important that we obtain a survey at a very high proportion of issued addresses, and therefore, you must ensure you are prepared to persuade householders of the importance of their participation.

Here are a few points, which may seem obvious, but we think are worth emphasizing:

- Know your survey
- Have your identity card easily accessible
- Dress neatly and appropriately
- Think positively

APPROACHING THE HOUSE

Again, many of the following suggestions may seem obvious, but their importance in securing as many surveys as possible has been emphasised to us by surveyors and interviewers alike:

- Don't park right outside the house
- Close the garden gate
- Don't stand on the doorstep - step back
- Be brief — don't say too much, or you may talk yourself out of a survey
- Smile
- Stress importance and assure confidentiality, and the fact that it is the only reliable source of housing information for Scotland
- Be prepared to answer questions
- Try to persuade refusals
- After your introduction, it can be helpful to give people a cue e.g. "Can we make a start now?" or "May I come in?"

INTRODUCTION TO THE HOUSEHOLD

You will need to adapt your introduction for different addresses. For most addresses, the households will have been included in the Interview survey and someone in the household will have taken part in an Interview. Because of the appointment system they know you are coming and you will be told their name. All addresses included in the Interview survey sample, will have at least been sent an introductory letter from Ipsos MORI.

Below is a suggested introduction. Of course, you will need to adapt yours to the particular situation, or may have your own technique.

"Good morning/afternoon/evening, Mr/Mrs I'm I am a surveyor working with Ipsos MORI, carrying out the Scottish Household Survey and I have an appointment for 'o' clock"

"I shouldn't take up much of your time. I just need to look around the inside and outside of your home, but I can do this by observation only and won't need to move anything.

TYPICAL DOORSTEP REACTIONS

Please think carefully about how you will respond if someone initially refuses to take part, and prepare yourself to persuade people to change their minds, perhaps by calling back a few days later.

“I never do surveys”

Answer — This survey is particularly important and we would greatly appreciate your help. We need to make sure it is accurate by covering all types of housing.

“I’m too busy”

Answer — If circumstances have changed since the appointment was made, I can call back whenever you like — (and again stress the importance of the survey).

“I’m an owner occupier, the survey is irrelevant to me”

Answer — it may appear to be, but many owner-occupiers who cannot afford to maintain their homes benefit from renovation grants from Government money administered by local Councils. This survey helps the government target this money to the Councils most in need. People living close to property in disrepair can see the value of their homes fall too. You may not qualify for or need a grant yourself, but grants do help to maintain the value of property, for everyone in the area

“My house is only two years old, the survey is irrelevant to me”

Answer — we need to include all types of homes to properly understand the overall condition of housing in Scotland. We also need to see if newer properties are proving durable and are satisfying the needs of today’s society.

“I’ve already done an interview, why should I take part in the survey”

Answer — We need both parts of the survey to give us a complete picture of housing in Scotland. The Interview alone is of limited value. This survey is a vital component of the SHS, and provides the government with the only detailed and reliable source of information of the condition of Scotland’s housing, which is vital for policy making and financial planning for the future.

“Hasn’t the government got enough information from the Census”

Answer — although the census provides very comprehensive information about the people who live in Scotland, the Government needs to carry out other surveys to obtain more detailed information about matters such as housing.

FREQUENTLY ASKED QUESTIONS

Below is a list of questions that you may be asked. With them is a list of answers. These are all answered on the explanatory leaflet that will be sent to all addresses in the sample.

What is the Scottish Household Survey?

Answer — The survey is carried out for the Scottish Government and is the main source of information on the condition and energy efficiency of housing in Scotland. The survey builds a picture of all types of housing in Scotland, whether owner occupied, owned by local authorities, housing associations or private landlords. The survey is in two parts — an interview with you the householder, and a survey by a qualified surveyor to assess the energy efficiency and condition of your home.

How is the survey used?

Answer - The survey aims to monitor the changing condition of the nation's housing, the distribution of poor housing and measure work required or being undertaken to the stock. The survey provides the Scottish Government with the major source of information to assist in the development and monitoring of policies directed towards the repair and improvement of the stock.

Why are you choosing my home?

It is too expensive to call on every address in the country so we select a few thousand addresses to represent the country as a whole. The addresses are selected at random from a national list of postal addresses. This gives everyone an equal chance of being able to help with the survey.

How do I know the surveyor is genuine?

All surveyors carry ID photo-cards, with a number to call if you want to check that they are who they say they are.

Should I let my landlord know I am taking part?

There is no need to do so, it is up to you. The survey is a visual one and will not damage the property in any way.

How long will the survey last?

Around 60 minutes, but much of this time will be spent outside

Is the information confidential?

Yes, all information collected from your home will be combined with all other homes in the survey. A report will be written summarising the results, and it will not be possible to identify any individual or home from the results.

A small number of households may be re-contacted by the survey team just to check that the survey has been conducted correctly and professionally.

You will never receive sales calls or direct mail as a result of taking part in the survey.

Can I have a copy of the survey?

While we can provide this, the data is collected purely for statistical purposes and is of no practical use.

OLDER PEOPLE AND GAINING ACCESS TO VULNERABLE HOUSEHOLDS

For older households you may need to adjust to their pace. It is important to respect their worries, and if they show any anxiety or confusion, you should offer to call back when a friend or relative is present. Always show your identity card, and the explanatory leaflet. You must not carry out surveys with only children present at the property, a child being defined for these purposes as someone under the age of 18.

OCCUPANT NOT AT HOME - NUMBER OF VISITS

If the respondent is not at home when you visit at the appointed time, you should contact the CADS Helpline immediately in order that they may try contacting the respondent by telephone for example, they may be running late. If contact cannot be made at that time, the CADS Helpline team will attempt to schedule a new appointment for you. If there is no telephone number recorded for the respondent, or if attempts by the Helpline to contact the respondent are unsuccessful, you should make a return call at a different time of the day, and on different days of the week.

You should make at least 4 visits in total to obtain a survey. If return calls are necessary, at least one should be in the evening or at a weekend. Such addresses can be held back until later weeks. You will make at least 4 attempts to contact the household in order to achieve a full survey if required.

HOUSEHOLD REFUSES BY TELEPHONE

It is also possible that some householders who initially agreed to an appointment for a Physical Survey may change their mind and ring to refuse. We will make contact with you as soon as possible to notify you of such refusals. If you receive a refusal from CADS, you must not carry out a Full Survey, but instead, carry out an abbreviated Dwelling Description.

TIME OF VISITS

You should not call at an address before 9.00 a.m. or after 9.00 p.m., unless requested to do so by the occupant.

6.5 Ensuring you are at the correct address

Rigorous sampling procedures have been followed to ensure that the data from the survey will be representative of all housing in Scotland, and it is therefore vital that as many households as possible have taken part in the Interview survey are then subsequently located for correctly for survey. The aim of the survey is to achieve as many paired cases of both a full Interview (or vacant) and full physical survey.

You must only visit and survey the selected address - no substitutions may be made.

All addresses with appointment details will have been visited by an interviewer from Ipsos MORI. You need to ensure that there are no discrepancies between the addresses you visit and those already visited by interviewers. If there are any discrepancies you should inform your Regional Manager.

This is also very important for the addresses that you visit where no social interview has been conducted. Again, if there are any discrepancies, you should inform your Regional Manager.

POSSIBLE REASONS FOR DISCREPANCY BETWEEN THE INTERVIEWER AND SURVEYOR

For occupied properties the only address shown on the website will be the address of the dwelling (as identified by the interviewer) at which an interview has been completed. You must check carefully whether you are at the correct address. The person answering the door may not be aware that an interview has previously taken place if it was carried out with a different household member. In these cases, double-check the website to see that you are at the correct address. The CADS Helpline can check the computer record if you phone them whilst still on site.

DIFFERENT ADDRESS VISITED FROM INTERVIEW SURVEY

If, on speaking to the household you establish that you are at a different address from the one visited by the interviewer, you must try to establish whether you are at the wrong address, or whether the interviewer has given you the wrong address to visit.

In this instance you must make general enquiries with the household to try and establish whether any changes have taken place, which would explain any apparent differences.

If you think you are at the wrong address, you must try to find the correct address. If, on the other hand, you are sure you are at the correct address, but an interview has not been conducted at this address you must contact the Helpline to clarify the situation for you before you proceed with your survey. You should telephone the CADS Helpline as soon as possible with the address details on 0131 558 8999. Helpline staff will do everything they can to assist you.

CHANGE OF HOUSEHOLDER

If you establish that a different household is present to the one interviewed by Ipsos MORI you should:

Ensure you are at the right address

Establish if there has been a genuine change in occupancy – in which case proceed with survey and record the exact date current occupants moved in

If the current occupants were resident at the time of interview contact the helpline. You need to take particular care over this issue. It is often the case that an interview may have taken place with one occupier who is not present when you call and has not informed other household members. You should advise the household that an Ipsos MORI interviewer will be in touch to conduct an interview. It would be helpful if you could obtain the householders telephone number and pass this onto the CADS helpline.

DIFFERENT OCCUPANCY STATUS

You may find that the interviewer has indicated that the dwelling was vacant, but you establish that it is occupied, and was occupied at the time of the Interview survey. In these instances you need to confirm you are at the correct address/dwelling. Please contact the CADS Helpline to confirm this with you, before proceeding with your survey. You must notify the CADS Helpline as soon as possible of any discrepancies, so that corrective action (e.g. conducting an interview) can be taken swiftly.

You should advise the household that an Ipsos MORI interviewer will be in touch to conduct an interview. It would be helpful if you could obtain the householder's telephone number and pass this on to the CADS helpline.

Similarly you may find that a dwelling shown as occupied at the time of interview is now vacant. You should ensure you are at the correct address and then seek to obtain a full survey as normal.

VALID PROPERTIES FOR SURVEY

You should carry out a physical survey based on the SHS definition of a dwelling contained in Section 3 of this briefing manual. Please note that dwellings without foundations, such as caravans, mobile homes or houseboats, are not considered eligible properties and you should inform your Regional Manager if any of your addresses are these types of dwelling. Additionally, if you come across any other unusual dwelling types, please telephone your Regional Manager for instruction on whether or not a survey is required.

Note that holiday homes or second homes are not eligible for a Full survey and only a Dwelling Description-type survey should be completed.

If the address you have been given is in fact a non-residential property please call to confirm the situation. If indeed it is not a residential property, you should not attempt a physical survey. However, if it contains residential accommodation, it should be included if it meets the definition of a dwelling with non-residential usage contained in the main manual.

You conduct the full survey, based on the dwelling and exclude any part of the address that is in current commercial use. Please refer to the appropriate section of the technical manual for full details.

DWELLINGS WITH OTHER USES

Where the survey address includes a non-residential use such as a shop, surgery, pub etc.. only the residential part of the internal part of the address should be surveyed. A residential dwelling must have an internal kitchen and toilet. If a communal kitchen/toilet is used, one that is shared with the non-residential use of the building, the dwelling is not eligible for a survey.

An exception is where a single room at the address is used as an office in what would otherwise be a residential property. In this case the 'office' should be included as a room and considered for survey.

6.6 Photographs

OCCUPANT'S PERMISSION

Whilst most householders have no objection to photographs being taken of their homes, a minority of people are sensitive to this (some only allowing photos of the front of the house, others voicing concerns about security, privacy etc.) You must always seek the permission of the householder, prior to taking any photographs. You should explain that the purpose of the photographs are that they are an aid to interpreting the data on the form and that they are kept strictly confidential to the survey. Photographs

should only be taken of the exterior of the dwelling, even though there may be internal problem areas.

You should ensure that householders are not included in the photographs you take of the dwelling. In line with the SHS promise of strict confidentiality, you should always assure the householder that the photos will not be used in reports, without the householders' express permission.

6.7 SHS Surveyor identity card

Each surveyor will be issued with an identity card. This must be shown to the household on initial contact. If the card is lost, you must notify Ipsos MORI immediately.

All identity cards must be returned to Ipsos MORI at the end of the survey period.

SHS Identity Card Scheme: Rules for Surveyors

The Surveyor:

1. Should do everything possible to ensure a continuing climate of good will, responsibility and trust and should leave respondents disposed to receive future contacts on research projects.
2. Must not mislead any respondent by giving inaccurate information.
3. Must not disclose any information given in confidence in an interview to any person other than those needing it to check the validity of the data or those engaged in processing them.
4. Must be polite and courteous at all times and allow respondents to withdraw at any stage of the survey, if they so wish.
5. Must always follow the instructions given by Ipsos MORI/the Scottish Government and its contractors.
6. Must always show the SHS Identity Card at the outset of the survey.
7. Must, if asked by the respondent, give:
 - the name of the person at Ipsos MORI (Chris Martin) responsible for the project
 - an explanation of why the respondent has been approached (e.g. the respondent's address is part of a representative sample.)
 - an explanation of why the respondent is being asked for personal information such as their name (so that Ipsos MORI/ Scottish Government can check the accuracy of the interview).
8. Should not call in person or by telephone a household before 9.00 am weekdays, 10.00 am Sundays, or after 9.00 pm any day, unless by appointment.
9. Must not carry out surveys with only children present at the property, a child being defined for these purposes as someone under the age of 18.

6.8 You and your Regional Manager

SUPERVISION

There are four, part-time, Regional Managers for the SHS. Your Regional Manager is present at your briefing, and will attend all the sessions with you. Regional Managers will help to ensure you have fully understood all the briefings and that you are recording data correctly. After your training, it is essential that you maintain contact with them, by phone or e-mail, while undertaking the surveys.

Although your Regional Manager will have had contact with you during your briefing exercise he/she will attempt to spend more time with you during the training course. This is to assess where you might be finding difficulties during the course and help you with your assessments.

ACCOMPANIMENT DURING YOUR FIELDWORK

You will be accompanied in the field by your Regional Manager within a very short time of your beginning your fieldwork. This will be a particular priority for surveyors new to the survey. Accompanied visits will give you the opportunity to resolve any problems that you may have encountered and to raise any individual problems that may arise. It will also enable your Regional Manager to ensure that each surveyor is carrying out fieldwork in a competent, efficient and professional manner.

WRITTEN ASSESSMENT

Your Regional Manager will make a written assessment of your performance at the end of the day's accompaniment. This will be passed to the Physical Survey Project Manager at Ipsos MORI.

If surveyor performance is judged not to meet the required standards, in terms of accuracy of forms completed, accuracy of judgments made, the Regional Manager will meet with you to try to correct the problem.

If there is still no improvement, your contract conditions may be invoked to terminate your contract on SHS.

6.9 Problems in the field

TECHNICAL PROBLEMS

Your Regional Manager will act as your first line of assistance in the field. Any technical problems you may have should be directed through to him/her, who may then refer any query on if necessary.

WORKLOAD PROBLEMS

If you are experiencing any difficulties in completing your workload, or you fall ill and cannot attend any appointments agreed, you must contact the CADS Helpline and your Regional Manager as soon as possible so alternative arrangements can be made.

REFUSALS

The occupant of any survey address is not obliged to permit a survey to be undertaken. If after explaining about the survey to the occupant, the occupant still does not wish

you to undertake the survey, you must not attempt to complete any part of the survey form while at the property. You should leave the property as quickly and politely as possible. Once you have left the property, complete the summary information required for the Abbreviated Dwelling Description.

SOCIAL PROBLEMS

You should avoid getting involved with social problems. If however you come across circumstances that cause concern, you should use your discretion, and discuss the issue with your Regional Manager. Remember that anything you see or hear in a household is confidential and should only be discussed with your Regional Manager or other senior staff at Ipsos MORI.

SAFETY OF SURVEY PARTICIPANTS

Should you have any concerns about the immediate safety of any survey participants, for example an exposed live electrical wire – you should inform your Regional Manager and the SHS Project Director as soon as possible.

6.10 Quality control

For quality control purposes, surveyors' performance will be monitored throughout the survey in a number of ways, which are set out below.

SUPERVISION AND REGIONAL MANAGERS' ASSESSMENT OF SURVEYORS

Regional Managers will monitor surveyor performance in a variety of ways. One-day accompaniment in the field, checking the first completed full survey forms for quality and completeness. Regional Managers will also monitor performance in terms of the proportion of broken appointments, the promptness of updating the website, and the speed with which survey forms are returned.

Your Regional Manager will contact you if there is a problem with any of these issues.

VALIDATION OF SURVEY FORMS

Each survey undergoes a validation process, whereby the data is cleaned by listing all errors on the form, e.g. implausible data or inaccurate data. This will highlight any surveyors with particularly high error rate. The validation process will be on-going throughout the fieldwork period. Surveyors will be notified if their survey forms show persistent and unacceptable error levels.

BACK-CHECKING ADDRESSES

Ipsos MORI will undertake a telephone back-check on a random sample of each surveyors' addresses, that have been returned and booked-in at Ipsos MORI, over the course of their fieldwork period. The call will ask the household to verify that a surveyor called to undertake the survey, and ask the household about how the survey was conducted, and the length of time at the address.

Regional Managers will also carry "back-check" inspections each year. These will be used to assess the quality of the scoring of the physical survey forms.

CADS WEBSITE

The following pages are your guide to the CADS SHS Website which is used to manage the allocation of addresses, record your availability, update survey actions and mileage.

You should refer to these pages when you first use the site.

The allocation of surveys will be conducted via a secure, dedicated website. All surveyors must therefore have access to both internet and e-mail.

Together with allocation of surveys, the website is used as a management tool to record all survey actions, provide “real-time” reporting information on how the survey is progressing, enable Regional Manager’s to monitor the workload of their surveyors and provides a complete audit trail for each individual survey.

All survey appointments made by Ipsos-MORI interviewers are transmitted to the CADS website daily, where Helpline staff will then allocate to surveyors based upon a pre-determined set of allocation rules.

Each surveyor will be provided with a password to access their part of the CADS website, where they will have a diary facility to view and update surveys which they have been allocated.

When survey appointments are allocated to surveyors by the CADS Helpline team (ie transferred to the surveyors’ diary), an automated confirmation email is generated by the CADS website and sent to the surveyor’s email address.

Surveyors can update the CADS website with their preferred availability for undertaking surveys. Such actions will greatly assist the CADS Helpline team in allocating surveys.

Updating survey actions is crucial to ensuring that the flow of information to all interested parties provides an overall picture, in real time, of how the survey is progressing. Therefore, and wherever possible, please upload your survey at the end of each surveying day.

At the end of each quarter, surveyors will be able to view their statement which contains a complete listing of all surveys they have completed, including mileage and any expenses they have incurred. Surveyors can then track the payment process from acceptance of their statement through to final payment.

Where an appointment has had to be re-arranged by the CADS Helpline team, such action will be recorded in the notes section of the appointment, including the initials of the CADS Helpline team member eg “(Booked by Helpline – ST); This is used for internal monitoring purposes. The CADS Helpline may also add additional notes for the surveyors information, as appropriate.

Prior to the commencement of fieldwork, you will be advised of the CADS website address and password information.

If you encounter any problems in either accessing the website or updating your survey actions, please contact the CADS Helpline in the first instance.

There is a guide to using the CADS website at the end of the administration section.

6.11 CADS helpline

CADS operate the SHS Helpline facility and are responsible for:

- Providing a Helpline facility to surveyors, general public and the Survey Management Team;
- Allocation of survey appointments to surveyors;
- Where necessary, re-arranging appointments;
- Monitoring surveyor availability;
- Monitoring case progress;
- Wherever possible, assisting surveyors with locating properties;
- Reporting to Ipsos-MORI Management.

The CADS Helpline is open during the following periods:

During Fieldwork Periods:

Monday-Friday 9am – 9pm

Saturday-Sunday 10am – 4pm

Outside Fieldwork Periods:

Monday-Friday 9am – 5pm

An answering machine is in operation outside of these hours

The CADS Helpline telephone number is 0131 558 8999.

The CADS Helpline email address is shs@cadshs.co.uk This is a group email to which all members of the CADS Helpline team are recipients, ensuring all emails are responded to quickly. In any event, you will receive a response within 24 hours.

6.12 Expenses

Surveyors will be expected to plan their workloads effectively to minimise the travel and subsistence component, taking the shortest route to and from survey addresses and any tolls or ferry charges, necessarily incurred and properly detailed, will be reimbursed at cost

For surveys involving no overnight stays:

- only travel-related expenses can be claimed
- when householders are not in at appointment time, you should always inform CADS.
- discuss 'cold call' trips in excess of 50 miles (round trip) with your RM/CADS
- if SHS surveys are being undertaken in combination with other work, only the relevant proportion of expenses should be claimed

- all expenses (bar mileage) need to be supported by receipts, which should be sent to your RM.

For surveys involving overnight stays:

- accommodation costs need to have prior approval of RMs
- the ceiling is £75 per night and covers both accommodation and subsistence (except in exceptional circumstances)
- if taking your partner and accommodation and subsistence is higher than £70 in total, you should claim only half. But if less than £50, can claim £50.
- higher than expected levels of expenses may lead to work being re-allocated

For island visits:

- previous points apply plus...
- you should discuss travel arrangements and associated costs with your RM
- if hiring a car, car hire and petrol should be invoiced rather than mileage
- travel arrangements should be booked in advance.

Expenses would ideally be paid as part of quarterly pay run. However, should they be sizeable or a long time until the end of the quarter, they will be processed on an adhoc basis. If this is the case, please discuss with your RM.

6.13 Best Practice

- Update your survey actions without delay.
- Always ensure you have future availability recorded on the CADS website.
- Contact the CADS Helpline if you are having difficulty locating a property.
- Inform the CADS Helpline if you are likely to be late for an appointment or any other unforeseen event which will prevent you from attending; Helpline staff will contact the householder to let them know and re-arrange an appointment where appropriate.

6.14 Useful Contacts

You should contact Ipsos-MORI direct with any queries about payments, or any queries regarding the management of the survey.

You should contact the CADS Helpline with requests for stationary (additional forms, replacement digital pen, calling cards etc), any queries about surveyor appointments, any issues regarding your availability or any queries regarding the CADS website.

For technical queries, you should contact your regional manager.

Ipsos MORI

- Chris Martin, Project Director (chris.martin@ipsos.com)
- Colin Hockaday, Senior Researcher (colin.hockaday@ipsos.com)

- SHS email queries (shs@ipsos.com)
- Address:
4 Wemyss Place
Edinburgh EH3 6DH
- Tel. 0808 238 5378

CADS

- Steven Tidy, Helpline Manager
- Moray Leask, Helpline Administrator
- Rosie McGeever, Helpline Administrator
- Liam Hamilton, Helpline Administrator
- Address:
6 Hill Street
Edinburgh
EH2 3JZ
- Tel: 0131 558 8999
- Email: shs@cadshs.co.uk

Section 7 The Social Survey

The social interview should last on average 60 minutes and is split into two main parts.

The first part of the interview must be carried out with any householder or their spouse/partner and concentrates on collecting basic factual information about the composition and characteristics of the household. There are a number of 'loops' within the questionnaire collecting the same basic information about everyone who lives there.

The second part of the interview will be with a randomly selected adult member of the household. This will not – by any means – always be a different person from the respondent for the first part of the interview. In single person households, the highest income householder and the random adult will, by definition, always be the same.

Only for a sub-sample, is a physical survey undertaken after the social survey.

The questionnaire brings together elements of the old SHS questionnaire, elements of the old SHCS question, together with some new questions.

The majority of the questionnaire topics will be asked of all householders and random adults. However, there are also sets of questions that will only be asked to a sub-sample. For example, the main set of questions from the SHCS, including the questions setting up the surveyor appointment, is only asked of one third of the sample.

At the end of the household questionnaire, for streams 1 to 4 (there are 12 streams in total) the script will ask interviewers to set up the surveyor appointments.

An overview of the different sections of the questionnaire is given below.

Household section

- Introduction
- Household grid
- Accommodation
- Sharing accommodation, internet access, recycling
- Driving and transport
- Young people in the household
- Health and Disability
- Noise
- SHCS module of household questions
- Employment of HH
- Household income
- Financial services
- Housing costs
- Surveyor appointment questions
- Permission to recontact

Random adult section

- Random Adult characteristics
- Accommodation
- Homelessness
- Neighbourhoods and community safety
- Discrimination
- Education and training
- Internet use
- Travel and transport
- Travel Diary
- Council services
- Volunteering
- Other services
- Leisure and spare time
- Mental health
- General health, disability and illness, smoking
- Random Adult employment
- Permission to recontact

Section 8 Health and Safety

8.1 Ipsos MORI Health and Safety policy

- 1) The promotion of safety, health and welfare at work is regarded as an important objective for all members of staff. The Company will ensure, as far as is reasonably practicable, the health, safety and welfare at work of all its employees/sub-contractors.
- 2) The Company continues to develop health, safety and environmental awareness and individual responsibility for health, safety and the environment amongst employees at all levels.
- 3) The Company will encourage full and effective consultation on health, safety and environmental issues.
- 4) The Company will provide all employees with the information, instructions, training and supervision they need to work safely and effectively.
- 5) The Company will maintain a safe and healthy working environment for employees with adequate facilities and arrangements for their welfare.
- 6) The Company will make every effort to prevent nuisance to the community and avoid damage to the environment.

ORGANISATIONAL ARRANGEMENTS

The overall and ultimate responsibility for health, safety and environmental protection rests with the Project Manager, who will specify how the policy will be implemented.

Whilst the prime responsibility for ensuring suitable and sufficient health, safety and environmental protection rests with the Project Manager, it is realised that health and safety and environmental problems are most effectively dealt with as close to source as possible. It is expected therefore that staff and sub-contractors will also have the responsibility for promoting a safe working environment for all concerned as outlined in the Health and Safety Policy.

The Project Manager will prepare, on the basis of the general policy, a risk assessment and comprehensive safe working procedures for the areas of responsibility that they are overseeing.

It is expected however that Staff of IPSOS MORI and sub-contractors while at work will:

- a) Take reasonable care of the health and safety of themselves and other persons who may be affected by their acts or omissions at work
- b) Co-operate with the firm's policy and procedures so far as it is necessary to allow them to carry out their legal duties relating to health, safety and environment matters including the wearing of protective clothing where required.
- c) Refrain from interfering intentionally or recklessly with anything provided for in the interests of health, safety and environmental protection.

- d) Report any hazard or unsafe working practices to the appropriate person and take appropriate action to protect others.
- e) Be aware of emergency procedures including the evacuation and fire precaution procedures in their area of work.

IPSOS MORI comply with requirements of the Health and Safety at Work Act 1974 and all other relevant legislation and regulations such as the Fire Precautions Act 1971.

IPSOS MORI has adopted approved Codes of Practice issued by the Health and Safety Commission and takes account of the guidance from Health and Safety Executive and other organisations.

8.2 Procedures for risk control

The Project manager has established a system of risk assessment for all activities. These assessments form the basis for measures taken to prevent accidents or occupationally related ill-health. The measures include

- 1) Jobs will be defined and specified in writing to ensure that areas of responsibility are clearly defined and understood.
- 2) New work methods and equipment will be assessed before introduction to ensure their safety and suitability
- 3) All health and safety hazards which cannot be eliminated will be identified so that associated risks can be assessed, controlled and maintained
- 4) The existence of hazards will be made clear and all Staff and Sub-contractors instructed and/or trained accordingly by the Project Manager or an appropriate member of staff.
- 5) Development of safe working procedures which will be recorded and published for definable work areas and, where appropriate, written permits to work systems will be used. Staff are trained in health and safety procedures at a level suitable for their own working environment and duties.

REPORTING PROCEDURES

- 1) Dangerous conditions involving immediate risk to a member of Staff and Sub-contractors should be made safe urgently by the best practical means. It is understood that those concerned will remove themselves from the situation/risk immediately.
- 2) All accidents, incidents and dangerous conditions should, in the first instance, be notified to the Regional Manager responsible, who will consult with the Project Manager if necessary.

TRAINING

In order to ensure that all members of Staff and Sub-contractors are aware of the Health and Safety at Work Act, IPSOS MORI recognises its duty to provide effective training to all Staff and such training will include

- a) General awareness of policy and procedures
- b) Ensuring that all Staff and Sub-contractors are aware of and accept and have the skills to discharge their responsibility regarding Health and Safety matters.
- c) Providing appropriate training for those other members of Staff with special duties
- d) Providing training on specific health and safety matters relating to particular jobs.

It is understood that IPSOS MORI are responsible for monitoring the effective performance of Staff and sub-contractors in relation to the implementation of the Policy and its procedures.

8.3 SHS Physical Survey – Health and Safety plan

In approaching the above job, we have had cognisance of our existing health and safety procedures and policy, but specifically we have designed a plan to deal with this task with objectives that are specific, measurable, achievable, realistic and which are given deadlines.

We have identified hazard and assessed risks to Staff.

We have established priorities according to risk.

We have implemented procedures to ensure that the risks are effectively controlled.

We have had cognisance in respect of this plan of the following documents:

- a) The Essentials of Health and Safety at Work
- b) Successful Health and Safety Management ISBN.

The task involves inspecting houses throughout Scotland and we have identified the following as hazards:

- 1) Exposure to risk if proper procedure is not followed when identifying houses
- 2) Danger to Staff/Sub-contractors from hidden obstacles
- 3) Dangerous staircases and balustrades
- 4) Danger from work on adjacent buildings where refurbishment is taking place
- 5) Possibilities of head injuries from falling materials
- 6) Exposure to uncontrolled animals
- 7) Exposure to the risk of contracting hepatitis B and AIDS
- 8) Violence to Staff/Sub-contractors.

We have assessed the hazard potential in the foregoing as serious and the risk potential as medium.

All Staff/Sub-contractors engaged upon this task will be made aware of the hazards in the following ways:

- a) A briefing session will be held at which the Staff/Sub-contractors will be informed of the task involved
- b) At that briefing, the likely hazards will be highlighted and the steps to avoid will be intimated
- c) All Staff/Sub-contractors will be informed that, upon inspection of the buildings, the set procedures should be followed
- d) It will be intimated that, in the event of any accidents of likely dangers, an immediate report should be made to the Regional Manager who is responsible, together with the Project Manager, by means of mobile phones, to which all operatives will have access
- e) All Staff/Sub-contractors upon inspections should carry a torch which should be regularly checked for its operating efficiency
- f) It is not expected that the Staff/Sub-contractors will be required to wear safety helmets, but if in the vicinity of building works, safety helmets should be worn and all Staff are provided with same

All Staff/Sub-contractors have been made aware of the fact that they have a statutory duty to take reasonable care of themselves and others who may be affected by their acts or omissions whilst at work. They are also being made aware of the policy which has been intimated to them by their employers, ie MORI, and that they must co-operate in implementing the requirements of that Health and Safety policy.

They have also been made aware that they must report any fault of defect they find in their activities which could endanger health or safety to the Project Manager responsible, who in turn will respond to MORI.

Section 9 Guidance on Safe Gas/Oil Heating systems and appliances (M25)

Safe gas and oil systems and appliances assessed against presence of the following:

- wall mounted boilers in danger of detaching
- rusted boilers or tanks
- leaking oil tanks or pipes
- holes in gas flues
- balanced gas flues with unsafe guards
- balanced gas flues with incorrectly positioned guards
- smell of gas/oil around boiler

Any of the above will result in the appliance being unsafe.

Is a domestic gas-fired appliance safe?

NOTE: This assessment of the safety of a gas system and or appliances within the dwelling takes into consideration an overall assessment of the physical condition of the appliances, the gas supply to the appliances, as well as the flueing and ventilation arrangements.

Natural gas and LPG are potentially dangerous substances. This assessment of the safety of the gas system and or appliances within a dwelling is a visual rating of the safety of the gas system or appliances using the guidance provided by the Scottish Household Survey. In no way should this visual assessment of the gas system or appliances, or the guidance, be considered, construed or seen to replace a gas safety check or an inspection of the gas appliance carried out by a qualified person under the requirements and regulations as set out by GAS SAFE Register and the HSE.

Recording the gas system as unsafe here does not imply necessarily that the system is dangerous. Conversely, recording the gas system as 'safe' does not imply necessarily that there is not a problem. The Surveyors for the Scottish Household Survey are not qualified to make such a definitive assessment.

Physical condition of appliance

There may be signs that a gas-burning appliance is in poor condition, and that this condition gives cause for concern.

The surveyor is to look for:

yellow/brown discoloration on the outer casing of the gas fire;

yellow/brown discoloration on the fabric of the dwelling surrounding the appliance;

yellow/brown discoloration on the removable elements within the gas fire;

broken elements, broken or missing switches;

broken or cracked glass covers on a gas fire;

broken or cracked glass covers on the pilot light viewing point.

Where such **visual evidence is found**, then these appliances should be **recorded as being unsafe**.

Carbon Monoxide Poisoning

When gas does not burn properly, as with other fuels such as coal, wood or oil carbon monoxide (CO) is produced which is poisonous. Every year about 30 people die from CO poisoning caused by gas appliances and flues that have not been properly installed or maintained. Many others suffer ill-health.

You cannot see it, or smell it, but CO can kill without warning in just a few hours. Symptoms of CO poisoning can include tiredness, drowsiness, headaches, giddiness, nausea, vomiting, and pains in chest, breathlessness, stomach pains erratic behaviour and visual problems. The affected person's face may have a cherry red complexion.

A householder is at risk of CO poisoning if the appliances are:

- poorly installed,
- not working properly,
- not been checked or maintained,
- not getting enough air as a result of inadequate ventilation,
- the chimney or flue gets blocked.

The Surveyor is to look for:

- yellow or brown staining around or on a gas-burning appliances,
- reports that pilot lights frequently blow out,
- high levels of condensation on windows
- yellow rather than blue flame when appliance is working.

You should not ask the householder if the pilot light is frequently blowing out on any appliance but should take note of any information given by the householder concerning the pilot light blowing out frequently.

Where such **visual evidence is found, or reported to the Surveyor**, then these appliances should be **recorded as being unsafe**.

NOTE: If any of the above characteristics affecting a gas-heating appliance are noted, the Surveyor is to contact their Regional Manager immediately.

NOTE: These notes apply to all gas-heating appliances in the dwelling, including gas-fired central heating boilers, balanced flue room heaters, as well as conventionally flued gas room heaters and fires, and gas room heaters with back boilers.

Ventilation

Open-flued appliances and boilers require an adequate supply of fresh air to ensure the combustion process is safe. Appropriately qualified GAS SAFE registered technicians are required to assess whether the particular fresh air requirements for any type of appliance, and whether the existing ventilation is sufficient. SHS surveyors are not qualified to assess whether a fresh air ventilator is or is not required, or that the ventilation from other sources is or is not sufficient. Therefore, surveyors should **record a system as unsafe if there is no fresh air ventilator in the room with the open-flued appliance**.

Broken or cracked flues

It is not uncommon to find older conventional open-flued appliances and boilers with a steel or ceramic flue pipe rising vertically from the appliance in the heated compartment before exiting through the roof or horizontally through the external wall.

Any signs of **cracking in the flue, or soot deposits on the outside of the flue** should result in the system being **recorded as being unsafe**.

Unsecured appliances

Any **floor standing boiler or appliance that has been clearly moved and separated from the wall (such as a DIY repair or relocation)** should be recorded as unsafe.

Any floor, or wall mounted heating appliance which is **not secured properly to the wall** should also be **recorded as unsafe**.

NOTE: If the back of the boiler or fire has become detached or pulled out of the flueing arrangements, and is still being used, this is dangerous, the system or appliance is to be recorded as unsafe and the Surveyor is to contact their Regional Manager immediately.

Open-flued appliances in bathrooms and shower rooms

It has been **illegal to install open flued appliances in bathrooms and shower rooms** since 1984. Surveyors should **record such appliances as unsafe**.

Reporting

The law requires that GAS SAFE registered technicians should report any dangerous gas fittings to the HSE within 14 days of finding them. There are no requirements to report illegal installations or installations which are not dangerous. “Unless there is good reason to believe they are dangerous they are not strictly reportable to HSE.”

Owner-occupiers are responsible for gas safety within their home, and ensuring their appliances are properly inspected and serviced by appropriately qualified personnel. Where surveyors consider appliances are unsafe they should inform the householder that the appliance may be potentially unsafe and ask them to have it (or them) inspected by an appropriate GAS SAFE registered technician. They should be asked to sign a form stating that fact, with a copy left with them.

For rented properties whether the letting agent or, landlord is responsible for gas safety, where surveyors consider appliances are unsafe they should inform the householder that the appliance may be potentially unsafe and ask them to have it, them inspected by their landlord.

They should be asked to sign a form stating that fact, with a copy left with them.

NOTE:



The Gas Safe Register replaced CORGI in April 2010. Only gas fitters registered on the Gas Safe Register are legally allowed to work on gas appliances in the home. It is a criminal offence for an unregistered person to carry out work on a gas appliance.

General advice to all consumers issued by National Gas Emergency service.

**GAS
ESCAPES**

Gas escapes may occur as a result of failure of the gas mains, failure of the supply or an appliance within the property, or as the result of accidental damage. Under certain circumstances these leaks can result in fire or explosion, and although the number of major incidents has been low, the hazards are serious.

If you smell gas, advise the householder:

DO: Switch off the appliance

Turn off the gas supply at the meter

Open doors and windows

DO NOT: Smoke

Use naked flames

Turn electric switches on or off, and then...

Call the National Gas Emergency service on 0800 111 999

The National Gas Emergency service operates a round-the-clock 365-days-a-year emergency service for gas escapes. They will stop an escape in the home or in the street free of charge.

If a domestic consumer needs a National Gas Emergency service engineer at their property, the engineer will carry out a soundness test at the meter to establish whether there is an escape on the customer side of the emergency control valve. The engineer will then inspect gas appliances and installations in the property, evaluating if there is an "Immediate Danger", whether there is an "At Risk" situation, a "concern for safety" or whether the property is safe.

Is a domestic oil-fired appliance unsafe?

NOTE: This assessment of the safety of an oil system and or appliances within the dwelling takes into consideration an overall assessment of the physical condition of the appliances, the oil storage supply to the appliances, as well as the flueing and ventilation arrangements.

This assessment of the safety of the oil system and or appliances within a dwelling is a visual rating of the safety of the oil system or appliances using the guidance provided by this survey. In no way should this visual assessment of the oil system or appliances, or the guidance, be considered, construed or seen as an oil safety check or appliance inspection carried out by a qualified person under the requirements and regulations as set out by OFTEC and / or the HSE.

Recording the oil system as unsafe here does not imply necessarily that the system is dangerous. Conversely, recording the gas system as 'safe' does not imply necessarily that there is not a problem. The Surveyors for the Scottish Household Survey are not qualified to make such a definitive assessment.

Oil-fired heaters and boilers are considered by the oil heating industry to be inherently safe as fuel burning appliances. Accidents involving them are considered to be extremely rare.

Physical condition of appliance

There may be signs that an oil-burning appliance is in poor condition, and that this condition gives cause for concern.

The surveyor is to look for:

- yellow/brown discoloration on the outer casing of the oil boiler
- yellow/brown discoloration on the fabric of the dwelling surrounding the appliance
- significant amounts of rust and corrosion of the boiler
- broken or missing switches
- cracked or broken glass on the pilot light inspection point

Where **such visual evidence is found**, then these appliances should be **recorded as being unsafe**.

Carbon Monoxide Poisoning

As with gas, when oil does not burn properly, carbon monoxide is produced, which is poisonous.

You can't see it, or smell it but CO can kill without warning in just a few hours. Symptoms of CO poisoning can include tiredness, drowsiness, headaches, giddiness, nausea, vomiting, and pains in chest, breathlessness, stomach pains erratic behaviour and visual problems.

A householder is at risk of CO poisoning if the oil-fired appliances are not properly installed, not working properly, not been checked or maintained, not receiving sufficient ventilation, or the chimney or flue gets blocked.

The surveyor is to look for:

- yellow or brown staining around or on appliances,
- odd smell around the appliance,
- soot around the appliance, flue or chimney,
- high levels of condensation on windows.

Where **such visual evidence is found**, then these appliances should be **recorded as being unsafe**.

Ventilation

Open-flued appliances and boilers and through the wall flued appliances require an adequate supply of fresh air to ensure the combustion process is safe. Advice from an appropriately OFTEC-qualified technician is required to assess the particular fresh air requirements for any type of appliance. SHS surveyors are not qualified to assess whether a fresh air ventilator is or is not required, or that the ventilation from other sources is or is not sufficient. Therefore, **surveyors should record a system as unsafe if there is no fresh air ventilator in the room with the open-flued appliance**.

Broken or cracked flues

It is not uncommon to find conventional open flued appliances and boilers with a ceramic or steel flue pipe rising vertically from the appliance in the heated compartment before exiting through the roof or horizontally through the external wall.

Any **signs of cracking in the flue, or soot deposits on the outside of the flue casing should result in the system being recorded as unsafe**.

Unsecured appliances

Any **floor standing boiler or appliance that has been clearly moved and separated from the wall (such as a DIY repair or relocation) should be recorded as unsafe**.

Any floor, or wall mounted heating appliance which is **not secured properly to the wall** should also be **recorded as unsafe**.

NOTE: If the back of the boiler or fire has become detached or pulled out of the flueing arrangements, and is still being used, this is dangerous, the system or appliance is to be recorded as unsafe and the Surveyor is to contact their Regional Manager immediately.

Oil Storage and supply

There may be occasions when the oil storage and / or oil supply system are recorded as unsafe.

Oil storage tanks should be designed for the purpose either as steel enclosed units or plastic units. **Any DIY oil storage arrangements such as open top plastic bins or tanks which are not sited on a secure base and ones, which have a temporary, unsecured hose supply line should be recorded as unsafe.**

Oil supply lines should be underground and fitted with a fire safety valve located outside the building. **Any oil lines, which are clearly on the surface of the ground, and are clearly temporary or unsecured, should be recorded as unsafe.**

A leaking oil storage tank or supply system is both a fire risk as well as a threat to the ground water. Kerosene emits a strong pungent smell. **A very strong smell may indicate a significant leak, as may a pool of oil below the oil storage tank. Such leaks should be recorded as unsafe.**

Significant staining of the ground may indicate that there is a current leak which should be recorded as unsafe, or there was one historically that has been since rectified which should **NOT** be recorded as unsafe. Minor staining may be indicative of sloppy filling of the storage tank which should **NOT** be recorded as unsafe. Where there is evidence of staining on the ground, the Surveyor should ascertain the original cause of the problem, and whether that problem has been resolved.

Evidence of corrosion of the storage tank, particularly on older oil tanks, should be recorded as unsafe.

Appendix 1 Digital Pen instructions

The Digital Pen instructions are available to download on the BRE website.

Appendix 2 CADS website instructions

The CADS website instructions are available to download on the CADS website.

Appendix 3 Guidance on scoring a conservatory

Definition:

A conservatory must meet all of the following conditions:

- Must have more than three quarters of the area of its roof and more than one half of the area of its external walls made of any clear or translucent material
- Must be attached to the dwelling
- Must provide enclosed weather protection
- Must be accessible from the interior of the dwelling
- Must have a floor area of more than 8m².

Scoring the form for a conservatory

- D6, Presence of a conservatory - Score 3 (or 4, if there is also a porch).
- F1 & F2 Room by room record – A conservatory on its own is NEVER a room. (But, where a room has been extended out in a conservatory type extension, then you will need to consider the adequacy of the ventilation of the original room together with the part extended out when you score the original room).
- L5 – Record presence of power sockets in conservatory.
- M23 – Record heating in conservatory.
- M24 – Record presence of door (any door) between dwelling and conservatory.

Section N is more complicated and depends on whether it is ‘thermally separately’.

“Thermally separated” means that any doors and windows separating the dwelling from the conservatory are of external quality. Single glazed windows and doors may provide thermal separation if the rest of the windows and doors of the dwelling are single glazed. If the rest of the dwelling is double glazed, then single glazed doors or windows to the conservatory do not constitute thermal separation.

If the conservatory **is thermally separated** from the dwelling, to completely ignore it when calculating the exposed perimeter of the adjoining floor and make no deduction from the exposed perimeter for the conservatory.

On the other hand, **if it is not thermally separated**, then measure and record it **in Section N** as Extension 1 or Extension 2 (unless there are 2 other more important

extensions). Enter 2 in the right hand box on the appropriate Extension line to show that it is a non-separated conservatory.

Note, when calculating the exposed perimeter of the ground/lowest floor (or whatever floor the conservatory adjoins) you deduct from the exposed perimeter of the main dwelling the length of the wall adjoining the **non-thermally separated** conservatory. And, when measuring the exposed perimeter of a non-thermally separated conservatory you deduct the length of wall shared with the main dwelling.

Scoring Part Q also depends on whether it is thermally separated.

- Part Q, External Construction/Materials – In Q26 or Q35, enter the NHER age of any **not thermally separated** conservatory (provided there are not 2 more important extensions).
- **Do not** record any other information in Part Q about any conservatories.
- **Do not** consider any conservatory for the principal roof type (Q19-Q22) or the secondary roof type (Q23-Q25).
- **Ignore it** for windows. (Q44 –Q50).

Appendix 4 Guidance on scoring extensions

For the purposes of the survey, an extension is defined a part of the dwelling that is thermally different from the main dwelling in relation to:

- the walls,
- the roof,
- and/or the floor.

By entering information about it separately from the main dwelling we can better model it within the energy model.

Ignore any extension (that is treat as part of the original dwelling) **that is less than 8m² or 10% of the floor area of the dwelling** (whichever is the larger).

The survey is only concerned with extensions to the dwelling being surveyed so, ignore extensions to the common block (that is just treat them as part of the original building) unless the actual dwelling being surveyed includes the extension.

We suggest you follow these steps when identify and scoring extensions.

Stage 1: Identify the original dwelling.

Remember the original dwelling may include an extension.

Stage 2: Identify any extensions.

There are three types of extension:

- Horizontal extensions
- Vertical extensions
- & Conservatories (these are covered in a separate briefing note).

Horizontal Extensions

Horizontal extensions lose heat to the outside through the roof, walls and floor.

A horizontal extension generally is a section of building added on to the sides of the original dwelling. Usually, an extension will have been constructed after the original building and, because of different construction materials, will have different thermal characteristics from the original building.

But an extension may also be a thermally distinct part of the original dwelling. It is likely to be distinct because of different construction. For instance, the extension may have a

flat roof whilst the rest of the building has a pitched roof or it may have a stone floor whilst the rest of the building has a suspended timber floor.

Remember, however, that if the “extension” (whether built at the same time as the original dwelling or later) is of the same construction and has the same insulation as the rest of the dwelling, it can simply be treated as part of the original building.

Check, therefore, before deciding if that single storey outshot on a two storey house needs to be treated as an extension or can be included with the main building.

An attached garage does not form part of the thermal plan envelope of the dwelling, so adding a floor on top of the garage or converting the garage itself into part of the dwelling creates a horizontal extension (because the floor has different thermal dynamics).

Creating additional space within a dwelling by converting roofspaces is not an extension for the purposes of the survey. The rooms in the roof space should be treated as Number of habitable rooms in roof space (J3) and Rooms in Roof (N5) whether built at the same time as the rest of the dwelling or added by conversion at a later date.

Vertical Extensions

Vertical extensions lose heat to the outside through the walls and either the floor or the roof. Effectively they share either a floor or a ceiling with the main dwelling. They do not have to extend beyond the original building envelope.

Therefore, if a new floor with external walls and new roof over is added to the original building, this is a vertical extension.

Also, if an integral garage (i.e. a ground floor garage with house to the side/s and on top) is converted into accommodation, this is a vertical extension (as long as it is thermally different from the rest of the dwelling (e.g. different building regulations age)).

Where there has been a vertical extension you must access if this forms rooms in the roof (See diagram for question J2). If this is the case then score as rooms in roof, NOT an extension, regardless of age and construction. Rooms in Roof take priority.

Only record 2 extensions. If there are more than two don't combine, but do add in notes. Where there is a 2 storey extension add both heights +0.25 at N. Vertical extensions often have non heat loss floors, if so record the construction as 8.

Examples of vertical extensions are given at the end of this appendix.

Stage 3: Examine the original building minus any extensions you are scoring.

What is now left is what you score in Q2 – Q18. The principal external wall of the original dwelling/building and the secondary external wall of the original dwelling/building do not need to be (but can be) thermally distinct. Most often they simply have different finishes.

Q10 – Extent of Principal External Wall – 10 here is what is left of the original dwelling/building minus any extensions. So if you give a score of less than 10 this is because

there is a secondary external wall to the original dwelling/building. (Just to make it clear – this number represents the proportion of remaining principal external wall to secondary external wall of the original dwelling AND NOT the proportion of original dwelling to any extensions).

Stage 4: If there are any extensions score them as Extension 1/Extension 2

Make sure that the extension 1 and extension 2 numbers is Part N tally with those in Part Q.

Special Note on Porches

Remember a porch must be separated by a door (any door, not necessarily an external quality door) from the remainder of the dwelling. If there is no door then there is no porch and what the layman would label a “porch” (because it sticks out door or not) should just be treated as part of the dwelling.

A porch will either be linked to the heating system in the dwelling and be heated or will be un-heated. An un-heated porch should be scored at D6 but otherwise should be completely ignored. A heated porch should be measured and recorded as part of the dwelling in Section N (that is area and exposed perimeter).



Examples of vertical extensions.



If this garage was converted into part of the dwelling, it would be scored as a horizontal extension.

Extension recorded at N and Q.

	<p>Should this integral garage be converted as part of the dwelling it would become a vertical extension (likely to be under separate building regulations and thermally different to main dwelling).</p> <p>Extension recorded at N and Q.</p>
	<p>Here there has clearly been a Vertical extension, where the rooms formed do not constitute rooms in the roof.</p> <p>A Vertical Extension.</p> <p>Extension recorded at N and Q.</p>
	<p>Similar properties, illustrating differing extension scenarios:</p> <p>Here there are extensions above the garage. Neither forms rooms in roof.</p> <p>These are both Horizontal Extensions.</p> <p>Extension recorded at N and Q.</p>
	

	<p>Here, identified by the build line, roof, internals and neighbours, there has been a two storey extension which incorporates a conversion of garage to dwelling with rooms above.</p> <p>As the garage was only originally attached, not integral, this forms a two storey Horizontal Extension.</p> <p>Extension recorded at N and Q. As a 2 floor extension add both heights + 0.25 for the height at N.</p>
	<p>Here the stonework clearly indicates a Vertical Extension.</p> <p>Internally you need to assess if a room in the roof: Is the external wallhead greater than 600mm below the ceiling level.</p> <p>If <600 then score as a Vertical Extension. If >600 record as rooms in the roof.</p>

Appendix 5 Guidance note on storage heating

Remember conventions for identifying Main Heating System 1:

- Choose any form of heating system over room heaters.
- Where there is a choice between two heating systems, select the system that heats the lounge as the Main Heating 1. The other becomes Main Heating 2.
- If both of the two systems heat the lounge, select the system that heats the largest number of rooms and, preferably the hot water as well as Main Heating 1.
- If neither system heats the lounge, select the system that heats the largest number of rooms and, preferably the hot water as well as Main Heating 1. (See Bill's new flowchart).
- If there is still a choice between two systems, select the one with the lowest running costs (i.e. fuel price divided by heater efficiency) as Main Heating 1. Usually, gas is cheapest, then oil, then solid fuel and then electric.

For storage heating to be present there must be at least one night storage heater. There does not need to be any other appliances. The storage heater/heaters must be connected to an off-peak type tariff. If storage heaters are run on a peak supply, then they should be scored as room heaters and you need to check for another central heating system.

Typically, modern storage heating systems involve a combination of storage heaters and direct acting electric heaters (e.g. panel heaters and/or fan convectors). The idea is that storage heaters heat the rooms they are in and that drift heat from them also warms (or at least takes the chill off) the rest of the dwelling. When these other rooms need to be fully heated, this is done with direct acting electric room heaters. Usually there is a storage heater in the living room and possibly the hall (but sometimes in many more rooms). Other rooms will be heated by panel heaters or wall-mounted fan convectors or similar. The combination of storage and other electric heaters forms the system - although the different types of heater are scored differently in F9.

Underfloor is a special case. See end of note.

Coding Electric Storage Heating Systems

- F9: Score 1 when there is an electric storage heater in the room. Score 2 when there is a panel or convector etc. heater in the room.
- K15: Generally, the controls of storage heaters are accessible to wheelchair users. But, in many instances, panel heater controls or convector controls are not accessible.
- L2: With a storage heating system, the meter type will be either dual (2) or 24 hour (3). The 24-hour tariff will be either Scottish Power's Comfort Plus Control tariff or a Scottish Hydro's Total Heating Total Control tariff (which is also known as THTC or Total Heating). Not all Teleswitches control 24 hour meters. The best way to establish the situation is to look at a bill or, in the case of Scottish Power, check the group code which should be written or stamped on a sticker on the Teleswitch. If there is a time clock attached to the meters, then it is a dual meter, not a 24 hour tariff
- M2: If storage heating is Main Heating 1, score 3.
- M3: Score 2 (appliance) NOT 1 (radiators).
- M4: In most small houses and flats the system will be full. But this is not always the case.
 - Some owners remove heaters completely from bedrooms. Some houses are large and the system is only installed in part of the house. In some houses there is no possibility of drift heat spreading through the house. In these cases the system will be partial.
 - In a typical 2 storey dwelling (3 bed or so upstairs, living, kitchen, and possibly dining downstairs), the system will be full if there is a storage heater in the living room (usually) and ground floor hall (and maybe one other downstairs room) and panel heaters in the bedrooms, bathroom etc. No storage heater is required on the upstairs landing.
 - The system is full if more than 50% of the rooms have either a storage heater or a panel/fan/convector heater installed in them.
- M5: Score 12 (off-peak electric) only. M6 - Score 8 (not applicable).
- M7, M8 & M9: Score 8 (not applicable).
- M10 a&b: Score 888.
- M11, M12, M13, M14 & M15: Score 8 (not applicable).
- M16: There are still some old style (option 3) heaters left (effectively pre 1978). These older heaters are substantially wider / larger than more modern slimline heaters and are typically 300-450mm deep and sit on the floor.
 - Most heaters will be new style (option 1) (post 1978, so they can still be quite old and battered now), usually in shades of grey or buff and 150-200 mm deep and usually sitting on angle brackets raising them off the

- floor. A standard new style storage heater has a one cable electric connection.
- Some new style heaters also incorporate a convector heater. The convector part requires its own power supply – so there will be 2 cable connections to the appliance. In M16 score this appliance as 1. (The convector part is an electric room heater (Option 6) when you come to M22)
 - A fan assisted storage heater (option 2 (fan assisted)) has a fan unit located at the bottom of the storage heater to blow air over the bricks. Only 1 fan assisted heater need be present for this option to be scored. This heater also requires a connection via 2 cables (one for the storage heater and one for the fan).
 - Some fan assisted storage heaters also incorporate a convector heater (sometimes denoted by 'turbo' in the name of the storage heater). This is likely to have 3 cables connected to the appliance. (Again the convector part is an electric room heater (Option 6) when you come to M22).
 - Integrated storage/direct (option 4) is relatively rare and consists of a storage heater with integral convector heater linked to a room thermostat and thermostat or a combined room thermostat and programmer. Creda EcoResponse and Dimplex Duoheat are of this type. To score 4 only one heater of this type need be present. This heater also requires connection via 2 cables, with the thermostat in the room.
- M17: In a standard storage heating installation the hot water is typically heated in a hot water tank by an electric immersion element which switches on at the same time as the night storage heaters and is on the same off peak supply. (Often there is a boost switch for when more hot water is needed.) Where this is the case do NOT score 1 (primary heating) even though it is part of the overall system. Score 2 (electric immersion) and in M18 score 12 (off peak electric).
 - Remember not all systems are standard - so check. Do not assume.
 - M21: If L2 was 2, score 11. If L2 was 3, score 12.
 - M22: Do NOT score 0 (no secondary system). If there is secondary heating (which must be some form of room heater), prioritise the secondary heating as per the primary heating. In the event that there is no secondary heating present at all, do not score 0 (no secondary system). Score 6 (electric room heater) even if there are none. This makes Bill and Dave happy. Some houses actually have night storage heaters in every room. Where this is the case, still score 6.

Underfloor heating

The survey considers electric underfloor heating to be a special type of storage heating.

Electric underfloor heating has been used since the early 1960s. The system consisted of electric wires buried in a screed. The wires heated the screed and the screed heated the room. It was installed in a lot of council flats and was (in poorly insulated homes) expensive to run. The wires in-screed system (now with improved insulation) is becoming popular again and now some mat and foil systems are also available. The mats sit directly under tiles, laminate floors or carpets. These new types of “underfloor” heating are NOT storage heating and should be scored as “room heaters” as they are usually not connected to an off-peak electricity tariff. Underfloor storage heating does not always cover the whole dwelling but is often found in association with direct acting room heaters.

For underfloor heating to be present it must be installed in at least one room. There do not need to be any other appliances. The underfloor heating must be on an off-peak type tariff. If the underfloor heating is run on a peak supply, then it should be scored as room heaters and you need to check for another central heating system.

Scoring Underfloor Heating

- F9: Score 1 when there is underfloor storage heating in the room. Score 2 when there is a panel or convector etc. heater in the room or when new mat or foil systems are present.
- K15: Generally, there is a room thermostat. Check the height. (Between 900 and 1050 is accessible).
- L2: As for night storage.
- M2: If underfloor is the primary source of heating, score 3.
- M3: Score 3 (underfloor).
- M4: The system should always be scored 2 (partial)
 - (Note that this does not apply to wet underfloor systems. Wet systems are normally full unless there is evidence to the contrary.)
- M5: Score 12 (off-peak electric) only.
- M6 to M9: Score 8 (not applicable).
- M10 a&b: Score N/A. Do NOT leave blank.
- M11 to M15: Score 8 (not applicable).
- M16: Score 5 (underfloor)
- M17: As per night storage
- M21: If L2 was 2, score 11. If L2 was 3, score 12.
- M22: As per night storage.

Appendix 6: Tips on dwelling drawings and measurements.

- The drawing or sketch on page 7 can be a great help to the surveyor and to the Team Manager. It allows the Manager to clearly understand the property as he has not seen it. It further assist the surveyor in making the necessary calculations in Part N.
- Do not prepare a full measured survey of the dwelling showing all rooms etc.
- Show simple calculations.
- Do the sketch at the property showing the habitable footprint including garages, porches etc and the relationship to adjoining properties.
- Either tidy up the sketch freehand or using the inbuilt drawing programme if necessary before forwarding to your TM.
- Take dimensions to the nearest 0.1 M
- Most properties are more easily measured using external sizes, this also avoids the risk of damages inside.
- Rooms in the Roof require internal sizes – part of which can be calculated from the outside sizes. Remember the ceiling height is from the floor to halfway up the sloping coomb.
- See worked examples in Section N of the Manual.
- See house type drawings in Section C and also attached to this guide.
- Remember you have answered the question on the thickness of the walls at Q7.
- Section N in the Manual is short and to the point but read it.
- Use solid lines for walls, dot dash lines for centre of party walls and dashed lines to indicate extent of Rooms in the Roof or Basement on your basic plan.
- Dimension lines are not normally required and sometimes confuse things.
- Keep it clear and simple.

Appendix 7: Guidance on scoring stairs on the upper floor of four-in-a-block properties.

Refer to the sketches on the next page showing four types of stairs in these types of properties.

Question	1 Wholly External Stair	2 Wholly Internal Stair	3 Mostly External Stair	4 Mostly Internal Stair
C2	Code 2	Code 2	Code 2	Code 2
D1	Code 1	Code 0	Code 1	Code 0
D4	Codes 1-4	Codes 1-4	Codes 1-4	Codes 1-4
E12	Code 2	Code 2	Code 2	Code 2
F1	All 0	Code 0 and 1	All 0	0 and 1
N1	1 st floor	Entrance	1 st Floor	Entrance
N2	888	1 st floor	888	1 st floor

Note the following

- R18: Score the outside stair.
- D1: External stair above halfway – code 1 and below. Halfway - code 0
- Section N: Floor measurements include stairs, halls and landings.
- D1, F1, J2 and N1/2 are answered in accordance with the number of steps inside and outside.

